

# **ELEMENTARY PRACTICAL ORGANIC CHEMISTRY**

## **PART III QUANTITATIVE ORGANIC ANALYSIS**

**By**

**ARTHUR I. VOGEL, D.Sc. (Lond.), D.I.C., F.R.I.C.**

Head of Chemistry Department, Woolwich Polytechnic  
Sometime Beit Scientific Research Fellow of the Imperial College, London

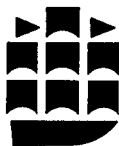

**LONGMAN**

LONGMAN GROUP LIMITED  
London  
*Associated companies, branches and representatives  
throughout the world*

© Arthur I. Vogel, 1958

*All rights reserved. No part of this publication may be reproduced,  
stored in a retrieval system, or transmitted in any form or by any  
means, electronic, mechanical, photocopying, recording, or other-  
wise, without the prior permission of the Copyright owner.*

*First published 1958*

*Sixth impression 1970*

*SBN 582 44243 5*

*Elementary Practical Organic Chemistry, Part I.  
Small Scale Preparations (Published 1957)*

*Elementary Practical Organic Chemistry, Part II.  
Qualitative Organic Analysis (Published 1957)*

PRINTED IN GREAT BRITAIN BY  
SPOTTISWOODE, BALLANTYNE AND CO LTD  
LONDON AND COLCHESTER

## PREFACE

THE writing of an authoritative text-book of elementary quantitative organic analysis is no easy task even for one who has had considerable experience of various branches of the subject. Apart from a knowledge of all the standard works and a detailed study of many hundreds of original papers in the literature, the main problem is the checking (and modifying, where necessary) of the large number of experimental procedures which are deemed suitable for a book of this kind. The checking of nearly all the methods has been undertaken by several members of the writer's teaching staff and research school during the last three years; the present volume records the results of these numerous experiments. Many determinations developed into minor research problems and their successful solution is due largely to the perseverance of the author's collaborators.

The book is concerned largely with quantitative organic analysis through the medium of functional groups. Nevertheless, it was felt that even elementary students should have some experience in the determination of a few selected elements in organic compounds: the first Chapter is accordingly devoted to such elements, of which nitrogen by both the Dumas and Kjeldahl methods is the most important. Numerous semimicro procedures for functional groups, involving the handling of 25 to 75 mg. of sample, are described. Macro methods are included also, and these can be used when sufficient of the sample is available. Particular attention is directed to titration in non-aqueous solvents, where these are applicable.

No claim is made that this volume deals with the determination of all the functional groups that are likely to be encountered. It is, however, considered that the number and variety of procedures are such that a reasonable choice is available to the student. It is also hoped that the book will prove useful to research and industrial chemists both as an introduction to the subject of quantitative organic analysis and also for use in the laboratory.

Quantitative organic analysis does not appear to have received the attention which it merits in the college and university courses in Great Britain. It is hoped that the present inexpensive laboratory manual will help to encourage the development of courses in the subject. The value of such courses for translating factual information acquired in the lecture room into quantitative work at the laboratory bench and also as a training in a variety of experimental techniques cannot be emphasised too strongly. None of the apparatus described in this book is unduly dear and considerations of cost should not therefore prevent any reasonably

equipped teaching institution from introducing a fairly comprehensive course in elementary quantitative organic analysis. The special glass apparatus, to the writer's design, is manufactured by Messrs. H. J. Elliott Limited, E-Mil Works, Treforest Industrial Estate, Pontypridd, Glam., Great Britain, and is obtainable from most laboratory supply houses\*.

In the writer's Polytechnic, quantitative organic analysis forms part of the laboratory course of students working for the Higher National Certificate in Chemistry, for the Graduateship of the Royal Institute of Chemistry, for the B.Sc. General degree, and for the B.Sc. Special (Honours) degree in Chemistry of the University of London. The results in all cases have been most gratifying.

The author's thanks are due to Messrs. W. T. Cresswell, B.Sc., C. M. Ellis, M.Sc., R. S. Parker, B.Sc., R. J. Townsend, B.Sc. and J. Watling, and to Drs. C. W. N. Cumper, R. Grzeskowiak, S. R. Landor and J. Leicester for checking and, in many cases modifying, the numerous experimental procedures; to Messrs. W. T. Cresswell and C. M. Ellis and Drs. C. W. N. Cumper, S. R. Landor and A. R. Tatchell for reading the proofs; and particularly to Dr. G. H. Jeffery, F.R.I.C., for a most critical reading of the proofs and for a number of useful suggestions.

Criticisms, information concerning errors, and also suggestions for new procedures and new techniques from lecturers and others are welcomed.

ARTHUR I. VOGEL

Woolwich Polytechnic,  
London, S.E.18.  
October 1957.

### ACKNOWLEDGMENTS

The five-figure logarithm tables (but in a modified set-out) are taken from E. Hope, *The Chemists' Book*, and are reproduced by kind permission of the publishers, Messrs. Sherratt and Hughes, Timperley, Cheshire, England. Permission to reproduce five-figure logarithm tables was also kindly granted by Messrs. G. Bell & Sons, Ltd., Portugal Street, London, W.C. 2, England, from their *Synopsis of Applicable Mathematics* by L. Silberstein, and also by Dr. A. Lange from his *Handbook of Chemistry* (Handbook Publishers Inc., Sandusky, Ohio, U.S.A.).

\* Available in the U.S.A. from The Ealing Corporation, Box 90, Natick, Massachusetts.

# CONTENTS

## CHAPTER XIV

### DETERMINATION OF SELECTED ELEMENTS IN ORGANIC COMPOUNDS

		PAGE
XIV,1.	Weighing and measuring techniques for semimicro quantities . . . . .	645
XIV,2.	Semimicro determination of nitrogen by Dumas' method . . . . .	646
XIV,3.	Semimicro determination of nitrogen by the Kjeldahl method . . . . .	652
XIV,4.	Semimicro determination of halogens by a modified Stepanow method (sodium-ethanolamine procedure)	657
XIV,5.	Semimicro determination of sulphur ( $\text{Na}_2\text{CO}_3$ - $\text{KNO}_3$ fusion method) . . . . .	659

## CHAPTER XV

### GENERAL DISCUSSION OF TITRATIONS IN NON-AQUEOUS SOLVENTS

XV,1.	Concepts of acids and bases . . . . .	663
XV,2.	Types of solvents . . . . .	665
XV,3.	Scope and limitations of titrations in non-aqueous solvents . . . . .	666
XV,4.	Titration of bases . . . . .	667
XV,5.	Titration of acids . . . . .	672

## CHAPTER XVI

### HYDROXYL GROUPS (ALCOHOLS)

XVI,1.	Discussion of selected methods for the determination of hydroxyl groups in alcohols . . . . .	676
XVI,2.	Determination of alcoholic hydroxyl groups by acetylation with acetic anhydride in pyridine . . . . .	677
XVI,3.	Determination of alcoholic hydroxyl groups by phthalation with phthalic anhydride in pyridine . . . . .	679

## CHAPTER XVII

### ADJACENT HYDROXYL GROUPS (POLYHYDRIC ALCOHOLS). PERIODATE TITRATIONS

XVII,1.	The Malaprade reaction and its application to the determination of polyhydric alcohols . . . . .	680
XVII,2.	Determination of polyhydric alcohols—iodometric procedure . . . . .	681
XVII,3.	Determination of polyhydric alcohols—acidimetric procedure . . . . .	683

## CHAPTER XVIII

## HYDROXYL GROUPS (PHENOLS)

	PAGE
<b>XVIII,1.</b> Discussion of selected methods for the determination of hydroxyl groups in phenols . . . . .	686
<b>XVIII,2.</b> Determination of phenols by acetylation with acetic anhydride in pyridine . . . . .	688
<b>XVIII,3.</b> Determination of phenols by bromination . . . . .	689
<b>XVIII,4.</b> Determination of phenols by titration as acids in non-aqueous solvents . . . . .	691

## CHAPTER XIX

## AMINO GROUPS

<b>XIX,1.</b> Discussion of selected methods for the determination of amino groups in amines . . . . .	695
<b>XIX,2.</b> Determination of amines by acetylation with acetic anhydride in pyridine. . . . .	697
<b>XIX,3.</b> Determination of amines by bromination . . . . .	698
<b>XIX,4.</b> Determination of amines by titration as bases in non-aqueous solvents . . . . .	698
<b>XIX,5.</b> Determination of the equivalent weight of an amine (base) by analysis of its chloroplatinate . . . . .	700
<b>XIX,6.</b> Determination of the equivalent weight of an amine by titration of its picrate in non-aqueous solution . . . . .	701

## CHAPTER XX

## SALTS OF AMINES (INCLUDING QUATERNARY AMMONIUM SALTS)

<b>XX,1.</b> Discussion of selected methods for the determination of salts of amines . . . . .	702
<b>XX,2.</b> Determination of amine salts by titration in aqueous solution . . . . .	703
<b>XX,3.</b> Determination of the halide salt of an amine by titration in acetic acid with acetous perchloric acid. . . . .	704

## CHAPTER XXI

## AMINO ACIDS

<b>XXI,1.</b> Discussion of selected methods for the determination of amino acids . . . . .	706
<b>XXI,2.</b> Determination of amino acids by titration as bases in glacial acetic acid . . . . .	708
<b>XXI,3.</b> Determination of amino acids by formol titration . . . . .	709

## CHAPTER XXII

## CARBOXYL GROUPS

	PAGE
<b>XXII,1.</b>	Discussion of selected methods for the determination of carboxyl groups . . . . . 711
<b>XXII,2.</b>	Determination of the equivalent weight of a carboxylic acid by titration with standard alkali solution in aqueous, aqueous-alcoholic or alcoholic solution . . . . . 714
<b>XXII,3.</b>	Determination of the equivalent weight of a carboxylic acid by titration with standard sodium methoxide solution in a non-aqueous medium . . . . . 716
<b>XXII,4.</b>	Determination of the equivalent weight of a carboxylic acid by iodometric titration . . . . . 716
<b>XXII,5.</b>	Determination of the equivalent weight of an acid by analysis of its silver salt . . . . . 717

## CHAPTER XXIII

## SALTS OF CARBOXYLIC ACIDS

<b>XXIII,1.</b>	Discussion of selected methods of analysis . . . . . 719
<b>XXIII,2.</b>	Determination of salts of carboxylic acids by titration in acetic acid with acetous perchloric acid . . . . . 720
<b>XXIII,3.</b>	Determination of alkali metal and alkaline earth salts of carboxylic acids by ignition . . . . . 721
<b>XXIII,4.</b>	Determination of the metal content of alkali metal or alkaline earth salts of carboxylic acids by conversion into sulphates . . . . . 722

## CHAPTER XXIV

## ANHYDRIDES OF CARBOXYLIC ACIDS

<b>XXIV,1.</b>	Discussion of selected methods of analysis . . . . . 723
<b>XXIV,2.</b>	Determination of anhydrides by esterification and hydrolysis . . . . . 724
<b>XXIV,3.</b>	Determination of anhydrides with morpholine . . . . . 726

## CHAPTER XXV

## ESTERS OF CARBOXYLIC ACIDS

<b>XXV,1.</b>	General discussion of various methods for the quantitative hydrolysis of esters . . . . . 728
<b>XXV,2.</b>	Hydrolysis by aqueous sodium hydroxide. Analysis of acetyl esters . . . . . 730
<b>XXV,3.</b>	Hydrolysis by alcoholic sodium or potassium hydroxide. Analysis of easily saponified esters . . . . . 731
<b>XXV,4.</b>	Hydrolysis by potassium hydroxide in diethylene-glycol. Analysis of difficultly saponifiable esters . . . . . 733

## CHAPTER XXVI

## ALDEHYDES AND KETONES

	PAGE	
XXVI,1.	Discussion of selected methods for the determination of aldehydes and ketones . . . . .	734
XXVI,2.	Determination of aldehydes and ketones by the hydroxylamine hydrochloride-pyridine procedure . . . . .	736
XXVI,3.	Determination of aldehydes by the sodium sulphite-sulphuric acid procedure . . . . .	738
XXVI,4.	Determination of carbonyl compounds with 2:4-dinitrophenylhydrazine . . . . .	739

## CHAPTER XXVII

## CARBOHYDRATES (SUGARS)

XXVII,1.	Determination of aldoses by titration with standard iodine and standard alkali. Theory . . . . .	740
XXVII,2.	Determination of aldoses by titration with standard iodine and standard alkali. Experimental procedure . . . . .	741
XXVII,3.	Determination of reducing sugars with the aid of Fehling's solution. Theory . . . . .	743
XXVII,4.	Determination of reducing sugars with the aid of Fehling's solution. Experimental procedures . . . . .	744

## CHAPTER XXVIII

NITRO, NITROSO AND AZO GROUPS,  
REDUCTION WITH TITANOUS SALTS

XXVIII,1.	General discussion of the determination of nitro, nitroso and azo groups by reduction with titanous salts . . . . .	747
XXVIII,2.	Preparation and standardisation of 0.1N titanous chloride and 0.1N titanous sulphate solutions . . . . .	749
XXVIII,3.	Determination of nitro groups . . . . .	752
XXVIII,4.	Determination of nitroso groups . . . . .	753
XXVIII,5.	Determination of azo groups . . . . .	754

## CHAPTER XXIX

## UNSATURATION

XXIX,1.	General discussion of selected methods for the determination of unsaturation . . . . .	756
XXIX,2.	Catalytic hydrogenation . . . . .	758
XXIX,3.	Determination of unsaturation by mercury-catalysed bromate-bromide titration . . . . .	765
XXIX,4.	Determination of unsaturation by the addition of iodine monochloride. Wijs' method . . . . .	767
XXIX,5.	Determination of unsaturation by the addition of iodine monobromide. Hanus' method . . . . .	768
XXIX,6.	Determination of unsaturation with pyridine sulphate dibromide and mercuric acetate catalyst . . . . .	769



## CHAPTER XXX

## ALKOXYL GROUPS

		PAGE
XXX,1.	Semimicro determination of methoxyl groups . . .	771
XXX,2.	Semimicro determination of ethoxyl groups . . .	775

## CHAPTER XXI

## C-METHYL, O-ACETYL AND N-ACETYL GROUPS

XXXI,1.	Semimicro determination of C-methyl, O-acetyl and N-acetyl groups. Theoretical discussion . . .	777
XXXI,2.	Semimicro determination of C-methyl groups . . .	778
XXXI,3.	Semimicro determination of O-acetyl groups . . .	780
XXXI,4.	Semimicro determination of N-acetyl groups . . .	781

## CHAPTER XXXII

## ACTIVE HYDROGEN

XXXII,1.	Discussion of methods for the determination of active hydrogen . . .	782
XXXII,2.	Determination of active hydrogen with methyl magnesium iodide in anisole or in amyl ether . . .	783
XXXII,3.	Determination of active hydrogen with methyl magnesium iodide in diethyl ether . . .	787
XXXII,4.	Determination of active hydrogen with lithium aluminium hydride in di- <i>n</i> -butyl ether . . .	789

## CHAPTER XXXIII

## ENOLS

XXXIII,1.	Discussion of selected methods for the determination of enols . . .	791
XXXIII,2.	Determination of enols by titration with bromine . . .	792
XXXIII,3.	Determination of enols by titration in non-aqueous solvents . . .	793

## CHAPTER XXXIV

## IMIDES

XXXIV,1.	Discussion of the method for the determination of imides . . .	795
XXXIV,2.	Determination of imides by titration in dimethylformamide . . .	795

**CHAPTER XXXV**  
**SULPHONAMIDES, THIOLS, SULPHIDES**  
**AND DISULPHIDES**

		PAGE
XXXV,1.	Discussion of selected methods for the determination of sulphonamides . . . . .	796
XXXV,2.	Determination of sulphonamides by acidimetric titration in a non-aqueous solvent . . . . .	796
XXXV,3.	Determination of sulphonamides with silver nitrate solution . . . . .	797
XXXV,4.	Discussion of selected methods for the determination of thiols . . . . .	798
XXXV,5.	Determination of thiols by the iodine method . . . . .	799
XXXV,6.	Determination of thiols by the argentimetric method. . . . .	800
XXXV,7.	Determination of thiols by the copper <i>n</i> -butyl phthalate method . . . . .	801
XXXV,8.	Determination of sulphides (thioethers) . . . . .	802
XXXV,9.	Determination of disulphides . . . . .	804

**CHAPTER XXXVI**

**DETERMINATIONS USING ION EXCHANGE RESINS**

XXXVI,1.	General discussion with special reference to salts of organic acids and of organic bases . . . . .	805
XXXVI,2.	Determination of salts of organic acids with the aid of cation exchange resins . . . . .	807
XXXVI,3.	Determination of salts of organic bases with the aid of cation exchange resins . . . . .	808
XXXVI,4.	Determination of alkaloidal salts with the aid of anion exchange resins . . . . .	808
XXXVI,5.	Determination of the saponification equivalents of esters. Alkali hydrolysis - ion exchange method . . . . .	809

**CHAPTER XXXVII**

**SOME APPLICATIONS OF THE**  
**KARL FISCHER REAGENT**

XXXVII,1.	The Karl Fischer reagent: description and general method of use . . . . .	813
XXXVII,2.	Some applications of the Karl Fischer reagent: theoretical discussion . . . . .	814
XXXVII,3.	Preparation of the Karl Fischer reagent: apparatus for its use . . . . .	817
XXXVII,4.	Determination of the water content of solvents, etc. with the Karl Fischer reagent . . . . .	821
XXXVII,5.	Determination of primary amines with the Karl Fischer reagent . . . . .	822
XXXVII,6.	Determination of acetic anhydride with the Karl Fischer reagent . . . . .	823

## CHAPTER XXXVIII

## ALPHA-EPOXY GROUPS (OXIRANE COMPOUNDS)

	PAGE
XXXVIII,1. Discussion of selected methods for the determination of alpha-epoxy groups . . . . .	824
XXXVIII,2. Determination of alpha-epoxides by the acidimetric method . . . . .	825
XXXVIII,3. Determination of alpha-epoxides by the argentimetric method . . . . .	826

## CHAPTER XXXIX

## MISCELLANEOUS DETERMINATIONS

XXXIX,1. Determination of formaldehyde . . . . .	828
XXXIX,2. Determination of acetone . . . . .	830
XXXIX,3. Determination of aromatic hydrazines (gasometric method) . . . . .	831
XXXIX,4. Determination of urea (gasometric method) . . . . .	833
XXXIX,5. Determination of urea (gravimetric method) . . . . .	835
XXXIX,6. Determination of organic peroxides and hydroperoxides . . . . .	836
XXXIX,7. Determination of isothiocyanates and of isocyanates . . . . .	837
XXXIX,8. Determination of carboxylic acids by conversion into S-benzyl- <i>iso</i> -thiuronium salts and titration with acetous perchloric acid . . . . .	838
XXXIX,9. Determination of alcohols by conversion into the alkyl xanthates and titration with acetous perchloric acid or with iodine . . . . .	839

## APPENDIX

A,8.* Atomic weights . . . . .	ii
A,9. Reference works for quantitative organic analysis . . . . .	iii
A,10. Vapour pressure of water at various temperatures . . . . .	vi
A,11. Four-figure logarithms . . . . .	vi
A,12. Five-figure logarithms . . . . .	vi
INDEX . . . . .	xxv

\* The numbering of the sections in the Appendix follows on from that in *Part II (Qualitative Organic Analysis)* of *Elementary Practical Organic Chemistry*.

# PART III

## QUANTITATIVE ORGANIC ANALYSIS

### CHAPTER XIV

#### DETERMINATION OF SELECTED ELEMENTS IN ORGANIC COMPOUNDS

##### XIV,1. WEIGHING AND MEASURING TECHNIQUES FOR SEMIMICRO QUANTITIES

FOR analytical work on a semimicro scale, the sample (ranging from 25 to about 75 mg.) is most conveniently weighed by means of a semimicro balance: weighings may be made directly to 0.01 mg. Semimicro balances\* are expensive and their correct use demands special care and precautions. The common form of prismatic reflecting balance † permits trustworthy and rapid weighing to 0.05 mg. and this should suffice for most of the determinations described in this volume. Thus the possible error on a weight of 50 mg. is 1 part in 500 (0.2 per cent.); this is usually less than the reproducibility of the subsequent operations in the analysis.

It is generally considered that weighings may be made on a good analytical balance by the method of swings ‡ with an accuracy of 0.02–0.03 mg. It is only under exceptional and favourable conditions that this accuracy can be achieved consistently, and it is doubtful whether, on average, weighings are reproducible to better than 0.05 mg. The somewhat laborious procedure of weighing by the method of swings is rendered unnecessary if a prismatic reflecting balance is available.

The properties of the compound determine the technique which must be adopted in weighing out a sample for analysis. If the substance is a solid and is stable in air, it may be weighed directly into a porcelain or silica boat or a small weighing bottle with externally ground cap (Fig. XIV, 1, 1). For weighing solids which are to be transferred to other vessels, such as Kjeldahl digestion flasks, the ground-glass, capped form of long-stem

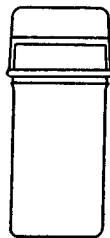

Fig.  
XIV, 1, 1.

\* The author has found the Oertling Semimicro Balance, No. 141, highly satisfactory; this is a prismatic reflecting type with 1 division = 0.01 mg.

† The Oertling prismatic reflecting balance, No. FO3 ("Tenth Milligram Aperiodic Balance, Releas-o-matic"), is employed by students in the author's laboratory: 1 division on the scale represents 0.2 mg. and one-quarter of a division = 0.05 mg. can be estimated with ease.

‡ See, for example, A. I. Vogel, *A Text-Book of Quantitative Inorganic Analysis: Theory and Practice*, Second Edition, 1951, pp. 155–158 (Longmans, Green and Co. Ltd.).

weighing tube (Fig. XIV, 1, 2) is convenient ; it is charged with the solid either by pushing the open container end of the weighing

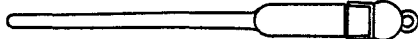

Fig. XIV, 1, 2.

tube into the substance or with the aid of a micro spatula. It is weighed on a metal support (Fig. XIV, 1, 3) on the balance pan.

The open weighing tube is held vertically and the Kjeldahl flask, etc., placed over it and then both are inverted ; the weighing tube is tapped gently against the side of the flask, withdrawn and weighed. The difference in weight gives the weight of the sample. Mention may also be made of the small weighing scoop illustrated in Fig. XIV, 1, 4 ; this is often useful for weighing solids which are stable in air.



Fig. XIV, 1, 3.

The weight of the sample may also be obtained by the difference method in which a closed weighing bottle with external ground cap containing the sample is weighed,



Fig. XIV, 1, 4.

some of the sample is transferred to the vessel in which the determination is being made, and the weight determined again. Liquids may be weighed by difference in the modified

form of weighing bottle shown in Fig. XIV, 1, 5 : it is fitted with a dropper pipette. Volatile or air-sensitive liquids may be weighed in sealed ampoules.

Many types of semimicro burettes are available commercially ; those with reservoirs and automatic zero adjustments are highly convenient in use (compare Figs. XXII, 2, 2 and XXII, 2, 3). The filling of pipettes, particularly with non-aqueous solutions, may be carried out with the devices shown in Fig. XIV, 5, 3 or Fig. XV, 5, 4.

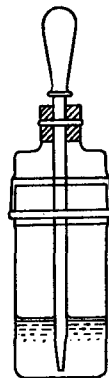

Fig. XIV, 1, 5.

## XIV.2. SEMIMICRO DETERMINATION OF NITROGEN BY DUMAS' METHOD

### THEORY OF THE METHOD

The Dumas combustion method can be used for almost all types of organic compounds that contain nitrogen. A known weight of the compound is burned in a closed system in an atmosphere of pure carbon dioxide, copper oxide being used as the oxidising agent. Oxides of nitrogen produced during the combustion are

reduced to elementary nitrogen by reaction with heated metallic copper. The nitrogen is collected in a graduated nitrometer containing a 50 per cent. solution of potassium hydroxide, the other products of combustion (carbon dioxide and any other acid vapours) being absorbed by the solution. The percentage of nitrogen in the sample is calculated from the volume of nitrogen collected.

### APPARATUS

The apparatus required for the determination consists of a correctly filled combustion tube in which the sample is burned, a tube furnace, a nitrometer to collect and measure the nitrogen, and a carbon dioxide generator. The assembly of these items is shown in Fig. XIV, 2, 1 (not drawn to scale).

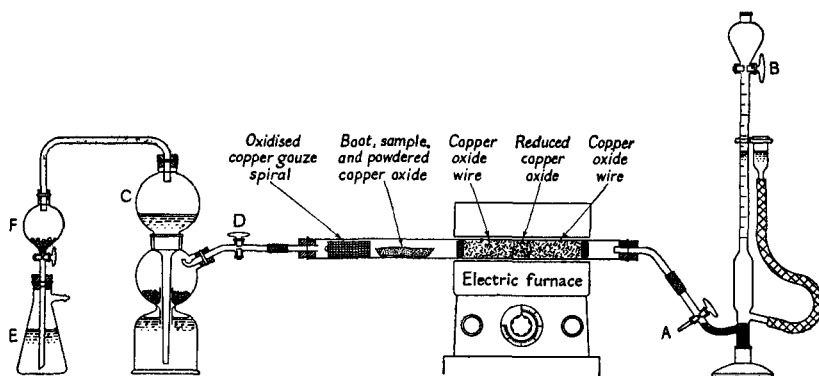

Fig. XIV, 2, 1.

**Tube furnace.** A commercial electrically-heated tube furnace\* with a tube length of 12" and an internal diameter of 2" is used. The furnace employed is wound to give a maximum temperature of 1050° C., but may be adjusted to a lower temperature by means of an energy regulator fitted to it. The energy regulator is set with the aid of a pyrometer to give a furnace temperature of 750° C.

**Combustion tube and filling.** The combustion tube is made of transparent silica; it is 60 cm. long with an internal diameter of 13–14 mm. and a wall thickness of 2 mm. Introduce a 3 cm.-long layer of copper oxide "wire-form" (wire, 2–4 mm. long; Micro Analytical Reagent) about 24 cm. from one end of the tube and hold it in position by means of 1 cm. spirals of copper gauze (ca. 40 mesh) on either side of the copper oxide layer. Displace

\* Type M91 manufactured by Wild-Barfield Electric Furnaces Ltd., Otterspool Way, Watford By-Pass, Watford, Herts, England, is both inexpensive and highly satisfactory.

the air in the tube by hydrogen derived from a cylinder and then heat the copper oxide gently with a Bunsen burner; stop the heating immediately the reduction commences. Burn the excess of hydrogen at a metal blowpipe jet. [The function of the reduced copper oxide is to reduce all oxides of nitrogen that are formed during the combustion, particularly nitric oxide which is not absorbed by the potash solution in the nitrometer.] Fill the tube with copper oxide ("wire-form") on both sides of the reduced copper oxide to a total length of 25 cm.; hold the filling in place by two 1 cm. spirals of copper gauze which just fit into the tube.

**Nitrometer.** The nitrometer has a capacity of 8 ml. and is calibrated in 0.02 ml. divisions. The small reservoir above the graduations serves to prevent splashing of the concentrated alkali when the gas is expelled from the azotometer and also to ensure that a small excess of potassium hydroxide solution is left as a liquid seal above the stopcock *B*. The three-way stopcock *A* permits the expulsion of air from the combustion tube by means of carbon dioxide without the latter gas entering the nitrometer, thus conserving the potash solution. Lightly lubricate the taps *A* and *B* with Silicone or Apiezon M grease and turn them until no striations are apparent. Introduce clean dry mercury into the nitrometer through the levelling tube until its level is about 5 mm. above the gas inlet near the stopcock *A*. Fill the rest of the nitrometer with 50 per cent. aqueous potassium hydroxide solution through the levelling bulb.

Prepare the so-called **50 per cent. potassium hydroxide solution** by dissolving 100 g. of potassium hydroxide (analytical reagent grade) in 100 ml. of water. Foaming of the reagent is reduced by adding 2.5 g. of finely-powdered barium hydroxide, shaking, and allowing to stand for 30 minutes to permit the suspended solid to settle. Filter the solution through a mat of purified asbestos on a Buchner funnel and store the filtrate in a bottle with a rubber stopper.

The rubber "pressure" tubing connecting the levelling tube with the nitrometer should be soaked for some hours in aqueous potassium hydroxide solution before attaching to the apparatus; if this is not done, sulphur may be extracted from the rubber and then react with the mercury in the nitrometer with the formation of black particles of mercuric sulphide, which render reading of the gas volume difficult.

The mercury acts as a seal and prevents any potassium hydroxide solution reaching the side arm connected with the combustion tube. The two reservoirs on the nitrometer should be provided with rubber stoppers (not shown in the Figure, but see Fig. XXXIX, 3, 1) fitted with short lengths of capillary tubing so that when the apparatus is not in use, the concentrated alkali solution may be kept almost out of contact with the atmosphere;

this will ensure that comparatively little absorption of carbon dioxide from the air occurs.

**Carbon dioxide generator.** The essential requirement is that the carbon dioxide supply should be air-free. The gas may be generated by the action of hydrochloric acid upon marble chips in a Kipp's apparatus *C*. Before use, etch the marble chips well with dilute hydrochloric acid, cover them with water in a large beaker and boil rapidly for 10–15 minutes. When almost cool, transfer the marble chips together with some of the water to a filter flask and add a further quantity of hydrochloric acid. When the vigorous reaction subsides, stopper the flask and connect the side arm to a water pump. Maintain the suction, with repeated shaking of the flask, until no more bubbles rise from the chips and the water is cold. Release the vacuum slowly so that the

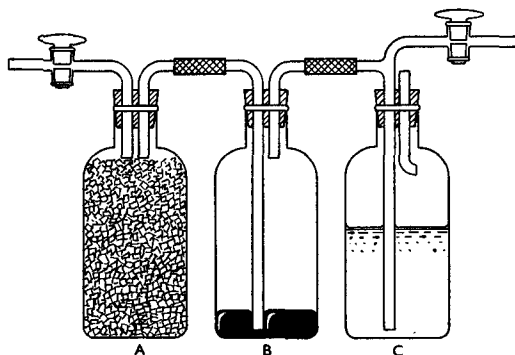

Fig. XIV, 2, 2.

pores of the marble become filled with dilute calcium chloride solution. Transfer the marble chips to the central chamber of the main Kipp's apparatus. Pour dilute hydrochloric acid (made from equal volumes of the analytical reagent grade hydrochloric acid and air-free water, and saturated with carbon dioxide by dissolving a few small deaerated marble chips in it) into the generator so as to fill the bottom bulb and one-third of the top bulb. Flush out the apparatus two or three times by opening the tap *D* fully until a vigorous evolution of gas takes place. It is recommended that an auxiliary generator be attached to the top of the Kipp's apparatus to prevent any air from dissolving in the acid. This may consist of a filter flask *E*, containing hydrochloric acid, into the neck of which is fitted the long stem of a cylindrical separatory funnel *F*. The funnel is charged with deaerated marble chips and is connected with the Kipp's apparatus by a gas-tight lead. The auxiliary generator works automatically: acid is sucked up by the fall in pressure in the top bulb of *C* when the latter is



functioning, whilst any excess of carbon dioxide escapes through the side arm of the filter flask.

An alternative generator, utilising solid carbon dioxide (Dry Ice or Drikold), is shown in Fig. XIV, 2, 2. It consists of three narrow-necked bottles of about 500 ml. capacity; each bottle is provided with a well-fitting, two-holed rubber stopper. *A* is really the generator and when in use is packed to the top with small pieces of Dry Ice: it is immersed in a vacuum flask. *B* is a lute containing mercury to a depth of 12–18 mm., sufficient to balance the head of the mercury trap of the nitrometer and provide a working pressure. *C* is a lute containing water saturated with carbon dioxide.

### PROCEDURE FOR THE COMBUSTION

Powdered copper oxide is required, and should be prepared by igniting copper oxide "powder" for 1–2 hours at 600–750° C. in a stream of carbon dioxide. Satisfactory results are also obtained by igniting copper oxide "powder" in a porcelain dish to a dull red heat (Fisher or Meker type burner) for 1–2 hours.

Set up the apparatus as depicted in Fig. XIV, 2, 1. Pass a slow stream of carbon dioxide through the apparatus with stopcock *A* turned so that the gas discharges into the atmosphere; it is essential to lower the levelling tube as far as possible during this operation to prevent any mercury running out of the apparatus should the tap be inadvertently turned to connect the nitrometer with the atmosphere. Switch on the tube furnace and regulate it so that a steady temperature of 700–750° C. is maintained.

Clean a combustion boat with dilute hydrochloric acid, rinse well with water, ignite in a Bunsen burner flame, and allow to cool. Weigh out the sample (25–60 mg. according to the nitrogen content) into the combustion boat containing a little ignited copper oxide "powder". Weigh to the nearest 0.05 mg. or, if possible, to the nearest 0.02 mg. Cover the sample with copper oxide "powder" and carefully mix the contents with the aid of a semimicro spatula. Fill the combustion boat almost completely with copper oxide.

Disconnect the carbon dioxide generator from the combustion tube, insert the porcelain combustion boat containing the sample and powdered copper oxide, and then introduce an oxidised copper gauze spiral (50 mm. in length; prepared by heating in a flame until uniformly black) behind it. Place the copper gauze spiral about 2 cm. behind the boat and about 10 cm. from the rubber stopper closing the end of the tube. Connect the carbon dioxide generator, taking care that the stopper fits tightly. Pass carbon dioxide through the apparatus for 10 minutes to displace all the air from the combustion tube. Raise the levelling bulb to fill the nitrometer with the solution, close tap *B* and lower the levelling bulb. Turn stopcock *A* so that carbon dioxide passes slowly

into the nitrometer. If the bubbles rising in the azotometer are almost completely absorbed, the process of sweeping the air from the tube is complete; otherwise, continue the sweeping process until only micro bubbles rise in the nitrometer. Force out all bubbles from the nitrometer by raising the levelling bulb and opening stopcock *B*. Close the latter, lower the levelling bulb and close stopcock *D*. Heat the combustion tube with a Bunsen burner, commencing at the end of the oxidised copper spiral nearest to *D* and gradually move the burner closer to the furnace until the combustion boat containing the sample is heated directly. The sample must not be burnt too rapidly as indicated by the rate at which gas collects in the nitrometer. The length of time required for complete combustion will vary with the volatility and size of the sample and is usually about 30 minutes.

When the combustion is complete, the nitrogen must be swept out of the combustion tube. Extinguish the Bunsen burner; open stopcock *D* cautiously so that bubbles rise in the nitrometer at the rate of about one per second. After 10–15 minutes, the bubbles will diminish in volume and those reaching the top of the solution will be pinpoint in size. Turn off all stopcocks and raise the levelling bulb so that the level of the liquid in it and in the nitrometer are about the same. Allow the nitrometer to stand for 10–15 minutes. Then carefully level the liquids in the nitrometer and levelling tube, and read the volume of nitrogen. Record the barometric pressure, the temperature at the barometer and also the temperature at the nitrometer.

### CALCULATION

The barometric pressure reading must be corrected for the vapour pressure of the potassium hydroxide solution by subtracting one-third of the nitrometer temperature (°C.).\* The barometer reading (in mm.) is also corrected for temperature by deducting one-eighth of the barometer temperature (°C.). The observed volume of the nitrogen must also be corrected for the liquid film on the walls of the nitrometer (due to the slow draining of the rather viscous potash solution): experience suggests that a deduction of 1.0 per cent. of the volume will adequately allow for this factor.†

\* Some typical vapour pressure figures for the 50 per cent. potassium hydroxide solution, due to E. P. Clark 1943, and expressed in mm. of mercury, are:—

15°, 5.5; 20°, 7.0; 25°, 8.9; 30°, 11.4.

† A composite correction for all the above factors is applied by subtracting 2 per cent. of the observed volume of nitrogen (Pregl). Niederl and Trautz (1931) suggest that, in addition to a correction for the air and absorption errors obtained from a blank analysis, a deduction of 1.1 per cent. of the observed volume of nitrogen be made. The present author prefers to deal with each correction separately since this will enable the student to appreciate the various sources of error and the approximations involved.

$$\begin{aligned} \text{Wt. of N}_2 \text{ at N.T.P.} &= \frac{V \times P \times 28.016}{(1 + \alpha T) \times 760 \times 1000 \times 22.415} \\ &= \frac{V \times P \times 1.2502}{(1 + \alpha T) \times 760 \times 1000} \end{aligned}$$

$$\text{Percentage of nitrogen} = \frac{V \times P \times 1.2502 \times 100}{(1 + \alpha T) \times 760 \times 1000 \times W}$$

where  $V$  = corrected volume (ml.) of nitrogen ;

$P$  = corrected barometric pressure ;

$T$  = temperature ( $^{\circ}\text{C}.$ ) at nitrometer ;

$\alpha$  = 0.003663 (=  $1/273$ ) ; and

$W$  = weight (g.) of sample.

*Substances suitable for determination* : acetanilide, aniline, benzidine, diphenylamine, benzanilide, dimethylglyoxime, and 1-chloro-2 : 4-dinitrobenzene.

It is recommended that, with a freshly packed combustion tube, a blank determination be carried out with analytical reagent grade glucose (ca. 25 mg.) ; this serves as an additional check on the purity of the carbon dioxide supply and also to burn out the tube and remove occluded air from the filling.

### XIV.3. SEMIMICRO DETERMINATION OF NITROGEN BY THE KJELDAHL METHOD

#### THEORY OF THE METHOD

A known weight of the nitrogenous compound is decomposed by digestion with concentrated sulphuric acid, preferably in the presence of a catalyst (e.g., a mixture of selenium, copper sulphate and potassium sulphate) to accelerate the process ; ammonium sulphate is produced. An excess of sodium hydroxide solution is added to the diluted reaction mixture, and the ammonia is distilled in steam, and absorbed in excess of 0.04*N* hydrochloric or sulphuric acid. Titration of the residual mineral acid with 0.04*N* sodium hydroxide gives the equivalent of the ammonia obtained from the weight of sample taken. The percentage of nitrogen can be easily calculated.

The reactions involved can be illustrated by reference to glycine :

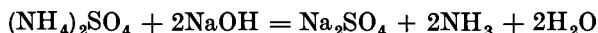
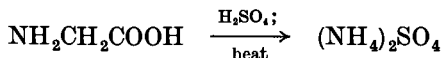

The ammonia may also be absorbed in saturated aqueous boric acid solution (this contains about 4 per cent. of boric acid) :

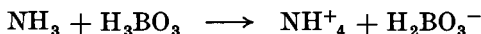

The ammonium borate formed can be titrated directly as an alkali with 0.04*N* hydrochloric acid, using screened methyl red as indicator :

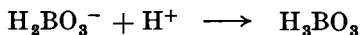

Boric acid is sufficiently acidic to react with ammonia and prevent loss by volatilisation, but is too weak an acid to interfere with the titration of ammonium borate with dilute hydrochloric acid. The advantages of boric acid solution as an absorbent for ammonia are (i) the measurement of an excess of standard acid is not necessary, (ii) no standard alkali is required, and (iii) the possible deleterious effect of carbon dioxide upon the colour change of the indicator is not encountered.

The simple procedure of digestion with concentrated sulphuric acid in the presence of a catalyst is applicable to amines, amino acids, amides and their simple derivatives. It cannot be used for nitro, nitroso and azo compounds, nor for hydrazones, oximes and nitrogen heterocyclic compounds such as pyridine. Satisfactory results can often be obtained by adding pure glucose to the digestion mixture. A more general method for such compounds is to subject them to a preliminary digestion with hydriodic acid of constant boiling point and then to submit the reduction product to the usual Kjeldahl treatment. Although the range of usefulness of the procedure is considerably extended by the preliminary reaction with a reducing agent, there are some compounds (*e.g.*, diazo ketones and certain semicarbazones) which do not give a quantitative yield of nitrogen.

### PROCEDURE

**Digestion.** Weigh out sufficient of the sample\* so that the ammonia liberated will neutralise about 10 ml. of 0.04*N* or 0.05*N* hydrochloric acid and transfer it to a clean, 50 ml. Kjeldahl digestion flask (Fig. XIV, 3, 1) that has previously been dried in an oven at 120° C. Add 1.0 g. of the catalyst mixture (prepared from 1 g. of selenium, 1 g. of cupric sulphate pentahydrate, and 20 g. of potassium sulphate; all finely powdered and well mixed). Measure out 5.0 ml. of concentrated sulphuric acid (analytical reagent grade) and pour it carefully into the flask. Insert a

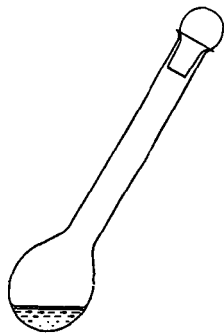

Fig. XIV, 3, 1.

\* The following weights of sample may be used: nitrogen content 7 per cent., *ca.* 90 mg.; nitrogen content 14 per cent., *ca.* 45 mg.; nitrogen content 28 per cent., *ca.* 25 mg. In many cases a solid sample may be weighed on a cigarette paper, which is then carefully folded and slid down the side of the flask. A weighing tube (Fig. XIV, 1, 2) may also be used.

loosely-fitting glass bulb with the drawn-out end downwards, and support the Kjeldahl flask in a stand so that it is slightly inclined from the vertical. Heat the mixture over a micro burner [Fume cupboard or hood!] so that the solution boils *gently* for 5 minutes, then increase the heating so that the solution boils vigorously and continue the heating for a further 45 minutes; the liquid should be colourless at the end of this period. Allow the digestion mixture in the Kjeldahl flask to cool, and dilute it cautiously with 10 ml. of distilled water.

Carry out a parallel blank determination using the same quantities of reagents except that glucose (analytical reagent grade) replaces the nitrogenous compound: this will serve as a

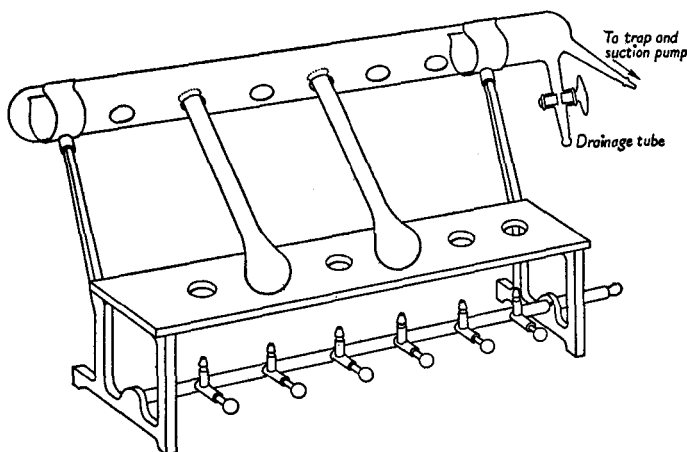

Fig. XIV, 3, 2.

test for the purity of the reagents. The blank determination is usually not necessary except where the compound has been subjected to a preliminary reduction with hydriodic acid.

The Kjeldahl method lends itself to the simultaneous analysis of several compounds. A special digestion stand (Fig. XIV, 3, 2) is available commercially. The stand consists of a Uralite or asbestos plate, with a series of 4 to 6 holes 2–3 cm. in diameter, placed immediately over a row of micro burners: it is provided with a glass manifold for drawing off fumes by means of a filter pump and also with a drainage tube.

**Distillation.** The distillation apparatus is shown in Fig. XIV, 3, 3 (not drawn to scale) and was designed by J. L. Hoskins (1944). The apparatus consists of a boiling flask *H* of 500 ml. capacity fitted with a three-way stopcock *A*; the latter is connected to a large outer chamber *B* having a pinchcock *F* at the

lower end. A "unit" (to contain the test solution) fits into the outer chamber *B* by means of a B50 ground-glass joint. The "unit" consists of a small chamber *C* (volume about 100 ml. below the internal bulb), which connects with the outer chamber by means of a tube *D*; it is attached to a reservoir *E* by means of a B14 ground-glass joint and to the condenser *G* through a spray trap.

Before the distillation, all the parts should have been cleaned with chromic acid mixture and thoroughly rinsed with distilled water; finally steam should be passed through the entire assembly to remove readily soluble alkali. When the apparatus is cold, place a 100 or 150 ml. conical flask *J* containing 25 ml. of 0.04*N* hydrochloric acid below the condenser, and adjust its height on a wooden support or in a clamp so that the end of the condenser dips 3–4 mm. below the level of the liquid. Transfer the diluted contents of the Kjeldahl flask quantitatively into *C* (it is advisable to smear the lip of the flask lightly with vaseline in order to prevent the solution from creeping over), rinse the flask three or four times with 5 ml. of water for each wash, using for this purpose a wash bottle with a fine jet. Keep the pinchcock *F* open during the transfer. Pass steam into the outer chamber *B* by turning the stopcock *A*, close the pinchcock *F*, and introduce 20 ml. of 40 per cent. sodium hydroxide solution via the funnel *E*: leave about 0.5 ml. in the funnel to serve as a liquid seal. Continue the passage of steam for 45–60 minutes to ensure that all the ammonia has passed over into the acid in *J*. Lower the receiver flask, and continue the distillation for 1 minute to wash out the condenser tube; rinse the liquid on the outside of the condenser tube into the acid with the aid of a fine spray of water from a wash bottle. Turn the stopcock *A* so that steam is cut off from the outer chamber; the contents of the inner chamber *C* are slowly sucked into *B* by the partial vacuum created by the steam condensing in the outer chamber. Run 20 ml. of water into *C* via the reservoir *E*; this will serve to wash out the inner chamber and will be sucked over into *B*. Run off

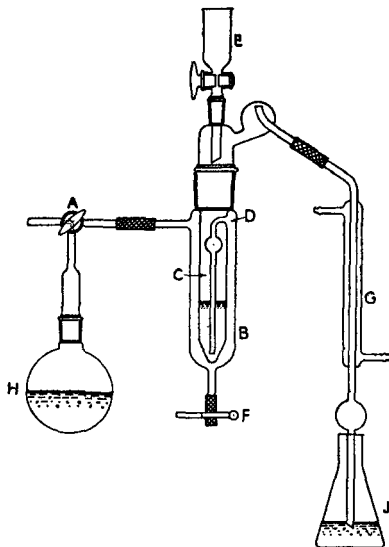

Fig. XIV, 3, 3.

the solution by opening the pinchcock *F*. Pass steam for about 20 minutes. The apparatus is then ready for another determination.

The excess of acid in the conical flask *J* may be titrated directly with standard 0.04*N* sodium hydroxide, using phenolphthalein as indicator. For beginners, it is usually better to transfer the contents of the flask to a 250 ml. volumetric flask, dilute to the mark with distilled water, and use 100 ml. portions for the titration.

If desired, 25 ml. of saturated boric acid solution\* may be employed for absorbing the ammonia evolved in the distillation. About 4 drops of indicator solution are added to the liquid in the receiver and it is then titrated with standard 0.04*N* hydrochloric acid. The best indicator is screened methyl red prepared by mixing as required equal volumes of methyl red solution (0.25 g. of methyl red in 100 ml. of ethanol) and methylene blue solution (0.186 g. of methylene blue in 100 ml. of ethanol). The first appearance of a violet colour is taken as the end point. An alternative indicator is methyl red - bromocresol green and is prepared by mixing 2.0 ml. of a 0.1 per cent. alcoholic solution of methyl red with 5.0 ml. of a 0.1 per cent. alcoholic solution of bromocresol green. The bluish-green colour of the indicator changes sharply to grey at the end point: the indicator is pink in acid solution.

Evaluate the volume of 0.04*N* hydrochloric acid which has reacted with the ammonia evolved and collected in the distillate. Also determine the volume of 0.04*N* acid consumed in the blank.

### CALCULATION

Calculate the percentage of nitrogen in the sample from the following formula:

$$\text{Percentage of nitrogen} = \frac{100(V_1 - V_2) \times 0.5603}{W}$$

where  $V_1$  = volume (ml.) of 0.04*N* hydrochloric acid consumed in the determination;

$V_2$  = volume (ml.) of 0.04*N* hydrochloric acid consumed in the blank; and

$W$  = weight (mg.) of sample taken.

$$1 \text{ ml. } 0.04N \text{ HCl} \equiv 0.5603 \text{ mg. N}_2.$$

*Substances suitable for the determination*: glycine, alanine, benzanilide, and diphenylamine.

\* The boric acid solution is prepared by dissolving 4 g. of boric acid in 100 ml. of water, boiling the solution for some time to expel carbon dioxide, allowing to cool and filtering, if necessary.

**Modifications of the simple Kjeldahl procedure.** These modifications are to be used for the analysis of nitro, nitroso and azo compounds and for many heterocyclic nitrogen compounds.

Transfer the weighed sample to the Kjeldahl flask and add 5 ml. of hydriodic acid (analytical reagent grade). Warm gently until the sample has dissolved, and introduce about 50 mg. of purified red phosphorus followed by a few small pieces of alundum, the latter to prevent bumping. Reflux the mixture for 30–45 minutes. Dilute the contents of the flask with about 5 ml. of water and add cautiously 5 ml. of concentrated sulphuric acid. Swirl the flask gently to mix its contents. Boil the mixture vigorously to remove hydriodic acid and the liberated iodine as rapidly as possible (**CAUTION:** bumping may occur); if all the iodine is not removed, add a little water, evaporate down again until the mixture fumes. Allow to cool, and add 1.0 g. of the catalyst and 5 ml. of concentrated sulphuric acid. Complete the digestion and distillation as described above.

Satisfactory results can sometimes be obtained by merely adding about 500 mg. of pure sucrose to the digestion mixture: the analysis is then carried out in the usual way. Good analyses are obtained with *p*-nitroaniline, *p*-aminoazobenzene, benzene-azo-resorcinol and helianthin.

#### XIV.4. SEMIMICRO DETERMINATION OF HALOGENS BY A MODIFIED STEPANOW METHOD (SODIUM - ETHANOLAMINE PROCEDURE)

##### THEORY

The original Stepanow method (1906) was based upon the reducing action of sodium and ethyl alcohol upon organic compounds containing reactive halogens, whereby the sodium halide was produced:

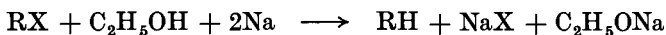

The procedure failed for a large number of aryl halides and poly-halogen compounds. Various improvements were subsequently suggested; these included the use of a fifteen-fold excess of sodium, and the use of an alcohol of high boiling point (such as *iso*-amyl alcohol) in order to give a higher reaction temperature. An excellent modification (due to W. H. Rauscher, 1937) utilises monoethanolamine: this solvent has a relatively high boiling point (171°), low viscosity and is soluble in water, cheap and easily purified. It reacts very slowly with sodium in the cold and the rate of reaction increases rapidly with rise of temperature; the reaction rate at high temperatures may be moderated by the



addition of dioxan, which is soluble both in monoethanolamine and in water. Monoethanolamine alone may be employed for aliphatic halogen compounds, but cannot be used for the usual type of aromatic halogen derivative with the exception of that containing active aromatic halogen such as 2 : 4-dinitrochlorobenzene. A mixture of dioxan and ethanolamine provides the reaction medium for most types of organic chlorine, bromine and iodine compounds with the exception of low boiling point compounds with firmly held halogen.

The halide ion formed is determined, after extraction with water and acidification with nitric acid, by the addition of an excess of standard silver nitrate solution and back-titration of the excess with standard ammonium or potassium thiocyanate solution and a solution of ferric alum as indicator. The silver halide may be removed by filtration through a quantitative filter paper or a G3 sintered glass crucible before the back-titration: this gives a solution free from the silver halide precipitate and facilitates the detection of the end point. Filtration is not generally necessary for silver bromide and silver iodide unless difficulty is experienced in detecting the end point in the presence of the cream or yellow precipitate of silver halide. Filtration of the silver chloride may be avoided by adding 0.1 ml. of nitrobenzene for each 5 mg. of chloride and shaking the precipitate vigorously until it settles out in large flakes: a film of nitrobenzene surrounds the silver chloride particles. Alternatively, the silver halide may be filtered off, washed, and weighed in the usual manner.

### PROCEDURE

Use a 50 ml. round-bottomed flask fitted with a condenser by means of a ground-glass joint. Weigh out accurately 50 to 75 mg. of the sample into the flask. Add 6.0 ml. of purified monoethanolamine (1) and 3.0 ml. of purified dioxan (2), followed by a piece of clean sodium weighing about 0.5 g. Attach the Liebig condenser. Warm the mixture gradually and, after any initial vigorous reaction has subsided, reflux gently for 30 minutes with frequent shaking. If all the sodium disappears during this period, add a further small piece. At the end of the heating period, allow to cool, and destroy any excess of sodium by introducing 2-3 ml. of water dropwise through the condenser. Wash down the condenser with 5-10 ml. of water; mix the contents of the flask thoroughly and cool to room temperature. Acidify the mixture to Congo red by adding 10 per cent. nitric acid dropwise from a burette with frequent cooling. (If a precipitate appears or the solution is turbid, filter through a G3 sintered glass crucible and wash with 1 per cent. nitric acid.) Transfer the liquid to a

250 ml. conical flask and wash the reaction flask thoroughly with distilled water. Add 10.00 ml. of standard 0.05*N* silver nitrate, coagulate the precipitate by warming on a water bath, cool, and titrate the excess of silver nitrate with standard 0.05*N* potassium thiocyanate, using ferric alum as indicator. Carry out a blank determination similarly, omitting the addition of the halogen compound.

### CALCULATION

Calculate the percentage of halogen from the formula :

$$\text{Percentage of halogen} = \frac{\{V_1 - (V_2 + V_3)\} \times f \times 100}{W}$$

where  $\{V_1 - (V_2 + V_3)\}$  = volume (ml.) of 0.05*N* silver nitrate consumed, corrected for the blank value ;

$V_1$  = volume (ml.) of 0.05*N* silver nitrate added ;

$V_2$  = volume (ml.) of 0.05*N* potassium thiocyanate used ;

$V_3$  = volume (ml.) of 0.05*N* silver nitrate consumed in the blank ;

$f$  =  $5 \times 0.3546$  for chlorine,  $5 \times 0.7992$  for bromine, and  $5 \times 1.2692$  for iodine ; and

$W$  = weight (mg.) of sample.

*Substances suitable for the determination* : *p*-chlorobenzoic acid, *p*-dibromobenzene and *p*-iodobenzoic acid.

#### Notes.

(1) The monoethanolamine is redistilled at atmospheric pressure and the fraction boiling at 169–171° is collected.

(2) Commercial dioxan may contain appreciable amounts of halogen. The latter is removed by refluxing 100 ml. of the commercial product with 5 ml. of monoethanolamine and 2 g. of sodium for 2–3 hours, and distilling. The product contains some ethanolamine but this is unimportant for the present purpose.

## XIV.5. SEMIMICRO DETERMINATION OF SULPHUR (Na<sub>2</sub>CO<sub>3</sub>-KNO<sub>3</sub> FUSION METHOD)

### THEORY

Certain non-volatile organic sulphur compounds may be oxidised by fusion with a potassium nitrate-sodium carbonate mixture. The sulphur is ultimately obtained in the form of the sulphate ion, and may be determined gravimetrically as barium sulphate. It may also be determined volumetrically by precipitation under standard conditions with a benzidine hydrochloride reagent, filtering off the precipitated benzidine sulphate, and then

titrating a suspension in water with 0.02*N* sodium hydroxide, using phenol red as indicator.

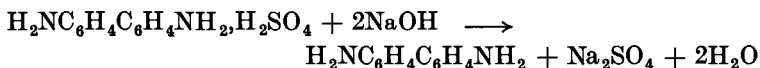
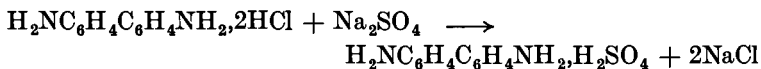

*i.e.*,



or



The volumetric method is employed for the determination of sulphur in biological materials usually after a preliminary Carius treatment with potassium bromide and fuming nitric acid. Its accuracy is checked with a standard solution of sodium sulphate.

### PROCEDURE (GRAVIMETRIC)

Prepare the fusion mixture by mixing 4 parts by weight of anhydrous sodium carbonate (analytical reagent grade) and 3 parts by weight of potassium nitrate (analytical reagent grade), and grinding the mixture to a fine powder in a glass mortar.

Weigh out accurately about 30 mg. of the sample into a clean 10 ml. nickel crucible, preferably with a reinforced bottom, and mix it thoroughly with 100 times its weight of the fusion mixture. Cover the resulting solid in the crucible with a thin layer of the fusion mixture in order to prevent sulphur-containing fumes from escaping. Place a close-fitting cover on the crucible and set it inside a 50 ml. silica crucible; cover the latter with its lid. Heat the crucible very gently with a low Bunsen flame, and gradually increase the heat until the maximum is reached after 15–20 minutes. Continue the heating for a further 15 minutes, extinguish the flame and allow the crucible to cool. Transfer the nickel crucible and lid to a 250 or 400 ml. beaker, cover it with water and boil to dissolve the melt. Add excess of bromine water and boil the mixture in order to oxidise any sulphide to sulphate and/or any nickelous oxide to nickelic oxide. Remove the crucible and lid with the aid of clean crucible tongs, wash them with a stream of water from a wash bottle and allow the washings to fall into the beaker. Filter the mixture through a quantitative filter paper (Whatman No. 542) and wash the beaker with a little water. Evaporate the clear filtrate to dryness; use a wire gauze initially and a water bath for the final stages to prevent spattering. Dissolve the residue in 25 ml. of 2*N* hydrochloric acid, heat to boiling, and precipitate the sulphate by the addition of 2 ml. of 10 per cent. barium chloride solution. Allow the precipitate to settle during one hour. Filter off the barium

sulphate through a small porous porcelain crucible, and wash it with hot distilled water until the filtrate is free of chloride. Dry the crucible in an oven at 120° C. for 20 minutes, then place it inside a large silica or nickel crucible, and ignite in the hottest Bunsen flame for 15 minutes. Allow the crucible to cool in a desiccator and weigh it. Repeat the ignition until constant weight is attained.

Calculate the percentage of sulphur in the sample using the formula :

$$\text{Percentage of sulphur} = \frac{B \times 0.1374 \times 100}{W}$$

where  $B$  = weight (mg.) of the barium sulphate ;

$W$  = weight (mg.) of the sample ; and

0.1374 = factor for conversion of  $\text{BaSO}_4$  to S.

*Substances suitable for the determination* : sulphanilic acid, sulphamic acid, toluene-*p*-sulphonic acid, sodium benzenesulphonate, and methyl orange.

### PROCEDURE (VOLUMETRIC)

Prepare the following reagents :—

*Benzidine hydrochloride reagent.* Dissolve 5.0 g. of pure benzidine hydrochloride in 40 ml. of *N* hydrochloric acid, add enough 50 per cent. aqueous ethanol (v/v) to give 250 ml. of solution. Heat to the boiling point, cool, filter (if necessary), and store in a dark, glass-stoppered bottle. This reagent is available commercially.

*Standard sodium sulphate solution.* Dissolve 2.2151 g. of anhydrous sodium sulphate (analytical reagent grade) in water and make up to 250 ml. in a volumetric flask. This reagent contains 2 mg. of sulphate ion per ml.

*Alcohol "reagent".* Mix 95 ml. of 95 per cent. industrial methylated spirit with 5 ml. of water.

*0.02N Sodium hydroxide solution.* This is prepared from the solid, analytical reagent grade. It may be standardised with 0.02*N* potassium bi-iodate solution or with 0.02*N* potassium hydrogen phthalate solution.

Carry out the determination exactly as described for the gravimetric procedure to the point where the solution after treatment with bromine water is evaporated to dryness on a water bath. Dissolve the residue (which contains about 5 mg. of sulphur) in 20 ml. of water, add 20 ml. of the alcohol "reagent", followed by 20 ml. of the benzidine hydrochloride reagent. Allow to stand for 30 minutes, and filter off the precipitate of benzidine sulphate through a quantitative filter paper (Whatman No. 542) supported on a small Buchner funnel, and wash it with three

5 ml. portions of the alcohol "reagent". Transfer the precipitate and filter paper to a 250 ml. conical flask, add 25 ml. of distilled water and a few drops of phenol red indicator (0.05 per cent. in 25 per cent. v/v ethanol). Heat the solution to boiling and titrate with standard 0.02*N* sodium hydroxide solution.

Calculate the percentage of sulphur in the sample from the relationship :

$$1 \text{ ml. } 0.02N \text{ NaOH} \equiv 0.32 \text{ mg. S}$$

Check the accuracy of the method by determining the sulphur content of 2 ml. of the standard sodium sulphate solution. Place 2.00 ml. of the sulphate solution in a beaker, add 8 ml. of the alcohol "reagent" and 4 ml. of the benzidine hydrochloride reagent. Allow to stand for 30 minutes. Filter off the precipitated benzidine sulphate, wash, and titrate with 0.02*N* sodium hydroxide as above

## CHAPTER XV

### GENERAL DISCUSSION OF TITRATIONS IN NON-AQUEOUS SOLVENTS

#### XV.1. CONCEPTS OF ACIDS AND BASES

Organic compounds having pronounced acidic or basic properties may be determined by acid-base titrations. Titration in aqueous solution is limited in scope because many such compounds are sparingly soluble in water and also the acidic or basic strengths are so slight that a sharp end point cannot be obtained. Titration in non-aqueous solvents permits the determination of numerous acids and bases which cannot be titrated in water, for not only are the solubilities different but also the acidic or basic properties can be modified by appropriate choice of solvents.

The Arrhenius theory stressed dissociation into ions. An acid was defined as a compound which ionised in water to yield hydrogen ions, and a base as one which gave hydroxyl ions: neutralisation was the interaction of an acid and a base to produce a salt and water. This theory is obviously inadequate for a discussion of reactions in non-aqueous solvents.

**The Brönsted-Lowry theory of acids and bases.** A more general theory of acids and bases was put forward almost simultaneously in 1923 by J. N. Brönsted in Denmark and by T. M. Lowry in England. They defined an acid as a species that has a tendency to lose a proton, and a base as a species that has a tendency to combine with a proton. These definitions may be expressed by the relationship :

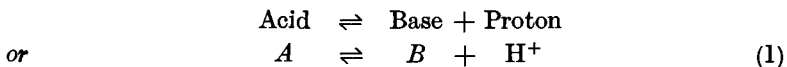

where  $A$  and  $B$  are termed a conjugate acid-base pair\*. The definition places no restriction on the sign or the magnitude of the charges on  $A$  and  $B$  except that  $A$  must always be more positive than  $B$  by one unit. The symbol  $\text{H}^+$  in equation (1) represents the bare proton and not the "hydrogen ion"; the latter has a variable composition depending upon the solvent ( $\text{OH}_3^+$ ,  $\text{NH}_4^+$ ,  $\text{C}_2\text{H}_5\text{OH}_2^+$ ,  $\text{CH}_3\text{COOH}_2^+$ , etc.). The definition is thus independent of the solvent: equation (1) represents a hypothetical scheme used for defining  $A$  and  $B$  and not a reaction which can actually occur.

The Brönsted-Lowry definition of an acid thus includes an electrically-neutral molecule (*e.g.*,  $\text{HCl}$ ,  $\text{H}_2\text{SO}_4$ ,  $\text{CH}_3\text{COOH}$ ), a

\* Every acid has its conjugate base, and every base its conjugate acid.

positively charged cation (*e.g.*,  $\text{NH}_4^+$ ,  $\text{C}_6\text{H}_5\text{NH}_3^+$ ), and a negatively charged anion (*e.g.*,  $\text{HSO}_4^-$ ,  $\text{HCO}_3^-$ ,  $\text{H}_2\text{PO}_4^-$ ,  $\text{HOOC}\cdot\text{COO}^-$ ). Similarly a base may be an electrically neutral molecule (*e.g.*,  $\text{NH}_3$ ,  $\text{C}_6\text{H}_5\text{NH}_2$ ), or an anion (*e.g.*,  $\text{OH}^-$ ,  $\text{OC}_2\text{H}_5^-$ ,  $\text{CH}_3\text{COO}^-$ ).

Since free protons cannot exist in solution, no reaction takes place unless a base is added to accept the proton from the acid. By combining the reactions

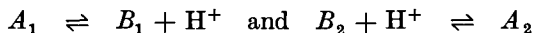

we obtain

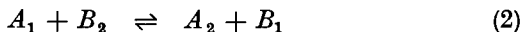

This is the most general expression for reactions involving acids and bases: it represents the transfer of a proton from  $A_1$  to  $B_2$  or from  $A_2$  to  $B_1$ . The stronger the acid  $A_1$  and the weaker  $A_2$ , the more complete will be the reaction (2). The stronger acid loses its protons more readily than the weaker; similarly, the stronger base accepts a proton more readily than does the weaker base. It is evident that the base or acid conjugate to a strong acid or a strong base is always weak, whereas the base or acid conjugate to a weak acid or weak base is always strong.

It is of interest to consider the titration of bases with the very strong acid perchloric acid in acetic acid as solvent. When perchloric acid is dissolved in acetic acid, the solution contains  $\text{CH}_3\text{COOH}_2^+$  ions, which can readily give up protons to react with bases, and is therefore strongly acidic:

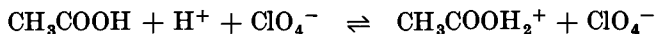

Acetic acid also dissociates to yield protons and is therefore itself acidic; it will exert a levelling effect on a weak base and the latter will thus have its basic properties enhanced. For this reason the titration of many weak bases with perchloric acid in acetic acid may often succeed when attempts to titrate the same bases in less acidic solvents, such as water, fail to give satisfactory end points.

**G. N. Lewis theory of acids and bases.** The acids considered on the basis of the Brønsted-Lowry theory are substances which contain hydrogen and which can behave as proton donors: they may be termed *H*-acids. This is a special case of the more general theory due to G. N. Lewis (1938).

G. N. Lewis defined an acid as an electron pair acceptor, and a base as an electron pair donor: neutralisation consists in the formation of a coordinate covalent bond. Acids includes such substances as boron trifluoride, stannic chloride and aluminium chloride as well as *H*-acids; these non-hydrogen containing substances are often referred to as Lewis acids or *L*-acids. The Lewis bases are virtually identical with those of the Brønsted-Lowry theory. Some examples of acid-base reactions follow:

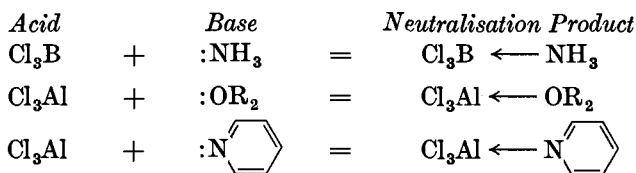

The formation of the coordinate bond is the first step in the neutralisation process: sometimes the product is a covalent compound. At other times the formation of the coordinate bond may be followed, or accompanied, by ionisation so that the product is a salt. Many Lewis acids react with indicators in aprotic solvents, *e.g.*, in chlorobenzene, boron trichloride will change crystal violet to the acid colour: addition of a base restores the basic colour of the indicator.

The major disadvantage of the Lewis system is on the quantitative side. Indeed, the chief justification for a separate treatment of proton or *H*-acids lies in the quantitative relations which they obey.

## XV.2. TYPES OF SOLVENT

The behaviour of acids and bases varies profoundly with the nature of the solvent. It is convenient to classify solvents in relation to the properties of water. Water possesses both acidic and basic properties (*i.e.*, is capable of both donating and accepting protons) and is termed an *amphoteric* or *amphiprotic solvent*. Amphoteric solvents include the alcohols ( $\text{CH}_3\text{OH}$ ,  $\text{C}_2\text{H}_5\text{OH}$ , *n*- $\text{C}_3\text{H}_7\text{OH}$ , etc.) and acetic acid; they are ionised to a slight extent. Thus acetic acid can exhibit acidic properties upon dissociation:

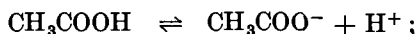

it can also exhibit weak basic properties by accepting protons to form a solvated proton of formula  $\text{CH}_3\text{COOH}_2^+$ :

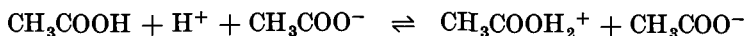

(Acetic acid is, however, predominantly an acidic or protogenic solvent.)

*Basic solvents* (or *protophilic solvents*), *i.e.*, solvents which are more basic than water, include ammonia, the amines and the ethers. They will react with an acidic solute with the formation of a solvated proton and the conjugate base of the acid:

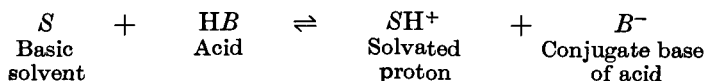



*Acidic solvents* (or *protogenic solvents*), *i.e.*, solvents which are more acidic than water, include anhydrous acetic acid, anhydrous formic acid and concentrated sulphuric acid.

It is important to note that if acetic acid is used as a solvent for uncharged bases (*e.g.*, amines), identical titration curves with a strong acid are obtained for all bases which are stronger than aniline. They must therefore be assumed to react completely with the solvent :

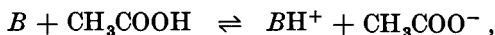

and such compounds (*e.g.*, the aliphatic amines and the alkyl-anilines, all of which are weak bases in water) behave as strong bases in acetic acid. Thus the strongly acidic properties of solvent acetic acid produce a pronounced **levelling effect**. Similarly, in a strongly basic solvent such as ethylenediamine or *n*-butylamine, acids of such varying strength in water as hydrochloric acid and acetic acid appear to react completely with the solvent as indicated by identical potentiometric titration curves :

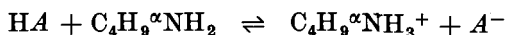

These acids are of essentially the same strength and the strong base acts as a levelling solvent by bringing the two acids to the same level of acidity.

*Aprotic solvents* are neutral substances, such as chloroform, carbon tetrachloride and benzene, which are chemically rather inert ; they neither gain nor lose electrons. They have a low dielectric constant, and do not react with either acids or bases. Ionisation is not likely to occur in such solvents. This is illustrated by the behaviour of picric acid (trinitrophenol) which gives a colourless and almost non-conducting solution in benzene, indicating that no dissociation has occurred. If aniline is added, the solution becomes yellow due to the formation of the picrate ion : the acidic properties of trinitrophenol become apparent only when a base is also present. Dissociation is not an essential preliminary to a neutralisation reaction. Aprotic solvents are often added to solvents which favour ionisation in order to depress solvolysis of the neutralisation product and so lead to a sharper end point.

### XV.3. SCOPE AND LIMITATIONS OF TITRATIONS IN NON-AQUEOUS SOLVENTS

Non-aqueous titrations may be applied to any compound which behaves either as an acid or as a base in a suitable solvent. Many compounds, which are of insufficient acidic or basic strength to give sharp end points in titrations in aqueous solutions, can be

titrated successfully in a levelling solvent which is able to enhance their acidic or basic properties. The end points may often be improved by the addition of aprotic solvents in order to depress the solvolysis of the neutralisation product. The range of compounds amenable to volumetric analytical procedures has been extended since there are suitable non-aqueous solvents for many compounds which are insoluble in water.

Potentiometric titrations are used for coloured solutions and also for compounds which remain feebly acidic or basic notwithstanding the levelling effect of the solvent. Visual indicators may be employed for compounds which behave as sufficiently strong acids or bases in appropriate non-aqueous solvents. The suitability of a visible indicator for a particular titration must be determined by performing a potentiometric titration and observing the colour change of the indicator simultaneously. For accurate results, the titrant should be used at about the same temperature as it was standardised; this is necessary because non-aqueous titrants usually have appreciable coefficients of expansion (compare Section XIX,4).

#### XV.4. TITRATION OF BASES

When a base  $B$  is titrated with an acid in a solvent  $S$ , the following equilibrium

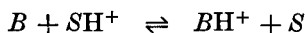

must be considered, where  $SH^+$  is the solvated proton from the titrant. A sharp end point will be obtained only if the equilibrium lies far to the right. This will occur if the base  $B$  is a stronger proton acceptor than the other bases (the solvent and the conjugate base of the acid used as titrant) present in the system: the solvent should therefore have no appreciable basic properties and the titrant should be a very strong acid.

Excellent end points are obtained with glacial acetic acid as solvent and perchloric acid as titrant. Even aromatic amines, which behave as very weak bases in water, give satisfactory end points in acetic acid. The best results are obtained if water is completely excluded. Since the titrant is made up by dissolving 70–72 per cent. aqueous perchloric acid in glacial acetic acid, some water is introduced: this water can be removed by adding the calculated amount of acetic anhydride and allowing the solution to stand for 24 hours to complete the reaction. The water content may be checked by a Karl Fischer titration (see Chapter XXXVII) and further adjustments made, if necessary, by the addition of acetic anhydride or water. Free acetic

anhydride must be avoided if primary or secondary amines are to be determined since acetylation will occur.

Solutions in cold glacial acetic acid may be handled in open vessels without appreciable contamination from atmospheric moisture. Compounds which are not readily soluble in cold glacial acetic acid may be dissolved by heating under reflux; during the subsequent cooling, the solution must be protected from atmospheric moisture by means of a drying tube.

Dioxan is sometimes used for the preparation of solutions of perchloric acid and as a solvent for the titration of aliphatic and heterocyclic amines. Some solutions of perchloric acid in dioxan

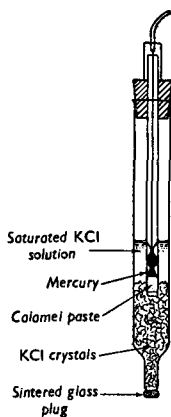

Fig. XV, 4, 1.

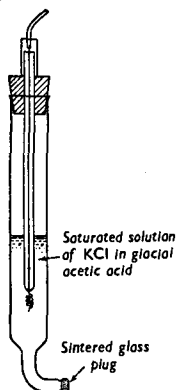

Fig. XV, 4, 2.

slowly become dark brown in colour: the coloration can usually be prevented by first shaking the dioxan with a cation exchange resin.

Aprotic solvents, such as benzene, chloroform, carbon tetrachloride, chlorobenzene, either alone or mixed with glacial acetic acid may sometimes be used for titration with acetous perchloric acid; they may lead to sharper end points.

**Potentiometric titration.** For potentiometric titration in acetic acid, a glass electrode may be employed as the indicator electrode. The reference electrode may consist of either a calomel half-cell (Fig. XV, 4, 1) or of a silver/silver chloride electrode (Fig. XV, 4, 2). Care must be taken to prevent leakage of potassium chloride from the calomel electrode into the titration liquid as this may cause errors due to the interaction of the potassium chloride with the perchloric acid titrant.

The silver/silver chloride electrode may be prepared by the thermal decomposition of a paste of silver oxide and water deposited

on a platinum wire; a part of the silver thus formed is then converted into silver chloride by electrolysis (R. G. Bates, 1954).

The silver oxide is obtained as follows. Dissolve 33.8 g. of silver nitrate in 300 ml. of water. Add a solution of pure sodium hydroxide in 40 ml. of water dropwise to the vigorously stirred solution of silver nitrate. A slight excess of silver should be present at the end of the precipitation. Shake the silver oxide vigorously with water in a glass-stoppered flask to remove soluble impurities. The washing must be repeated at least 25 times to ensure complete removal of the impurities as indicated by a constant conductivity of the wash water.

Seal a length of 26 S.W.G. platinum wire into the end of a flint glass tube so that 2 cm. of wire projects below the seal. Form the wire into a helix about 7 mm. in length and about 2 mm. in diameter; clean it by immersion in warm 6*M* nitric acid, followed by thorough washing in distilled water. Apply a thick paste of well-washed silver oxide and water to the helix. Suspend the electrode in a muffle or crucible furnace at 500° C. and maintain the temperature until the paste is completely white (at least 10 minutes). After cooling, apply a second thinner coating of silver oxide paste and repeat the heat treatment: a smooth surface is thus formed on the electrode. The weight of silver deposited on the electrode is about 150 to 200 mg. Electrolyse the silver-coated wire as an anode in a 1*M* solution of twice-distilled hydrochloric acid (analytical reagent grade) using a platinum wire as cathode, and pass a current of 10 mA. for 45 minutes; 15–20 per cent. of the silver will be converted into silver chloride. Immerse the electrode in 0.05*M* hydrochloric acid overnight and then store in distilled water until required. At least two electrodes should be prepared: their potentials should not differ by more than 0.1 mv. Thick coats of silver chloride should be avoided as they tend to make the electrodes sluggish. The best silver/silver chloride electrodes are light grey to white in colour.

A direct reading *pH* meter, also provided with a millivolt scale\*, may be used for titration in non-aqueous solvents. The readings of *pH* are, of course, arbitrary since *pH* has no significance in non-aqueous solutions; the millivolt scale is generally used.

A titration may be performed in a small beaker or in a small three- or four-necked flask. Mixing is conveniently effected by a magnetic stirrer (compare Fig. XV, 5, 2). A typical titration assembly is shown in Fig. XV, 4, 3†. The semimicro burette should preferably be of the automatic filling type.

The results of the titration may be presented simply as a direct titration curve (Fig. XV, 4, 4) in which uncorrected meter readings are plotted as ordinates and burette readings as abscissae. (The curve shown is one obtained in the standardisation of acetous

\* The *pH* meters supplied *inter alia* by Electronic Instruments (Richmond), Pye (Cambridge) and by Beckmann (U.S.A.) are satisfactory.

† The *pH* meter, electrodes and stand illustrated are supplied by W. G. Pye and Co. Ltd., Newmarket Road, Cambridge, England.

perchloric acid with potassium hydrogen phthalate.) Alternatively, a differential titration curve (Fig. XV, 4, 5) may be plotted as follows. Choose about six points on either side of the approximate end point and plot  $\Delta E/\Delta V$  against  $V$ : a small value (e.g., 0.04 ml.) should be used for  $\Delta V$ ; the intercept from the maximum on to the abscissae axis gives the end point in units of  $V$ .

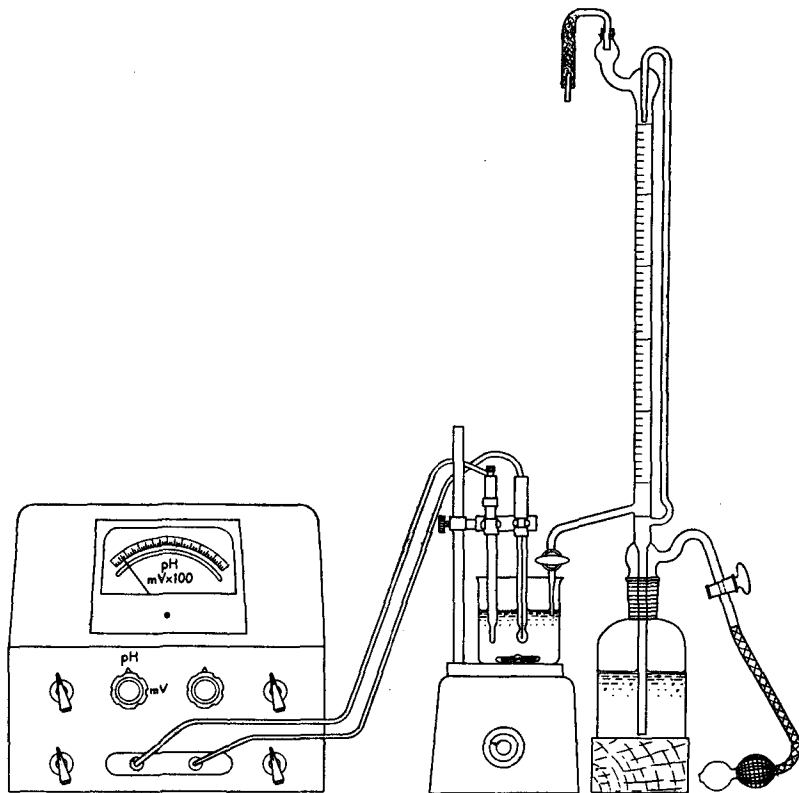

Fig. XV, 4, 3.

**Indicators.** Substances which react as strong bases in solution in acetic acid may be titrated with acetous perchloric acid with the aid of visual indicators. The suitability of the indicator is determined by potentiometric titration with simultaneous observation of the colour change of the indicator. These colour changes may be recorded on the titration curve (see Fig. XV, 4, 4 wherein the colour changes for crystal violet are set out) and the colour at the correct end point found by noting that which corresponds to the inflection point of the curve. This is essential since

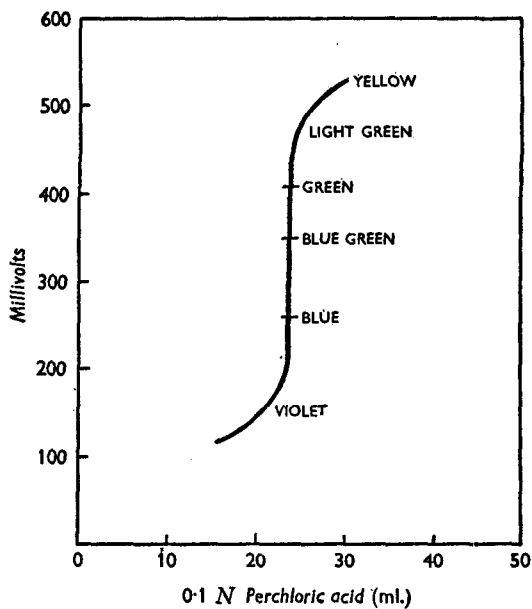

Fig. XV, 4, 4.

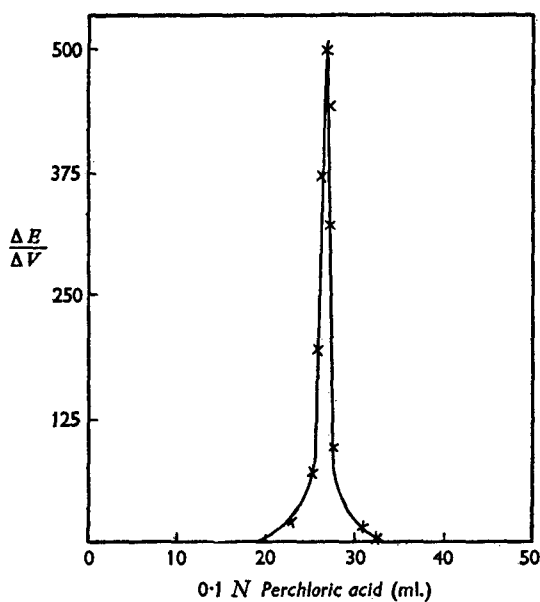

Fig. XV, 4, 5.

the colour change at the end point may vary with the compound being titrated. The colour change is not usually simple.

Indicators which have been used include crystal violet (0.5 per cent. w/v in glacial acetic acid), methyl violet (0.2 per cent. w/v in chlorobenzene) and  $\alpha$ -naphthol-benzoin (1 per cent. w/v in glacial acetic acid). The colour changes for crystal violet in acetic acid solution are as follows when acetous perchloric acid is added gradually: violet to blue, then through several shades of green, and finally to yellow. Methyl violet changes from violet to blue.

## XV.5.

### TITRATION OF ACIDS

**Solvents and titrants.**—The ideal solvent for the titration of acids should readily dissolve a large variety of acidic solutes and be devoid of acidic properties itself. The titrant should be a solution of a strong base in a non-acidic solvent and possess good keeping properties.

A mixture of benzene and methanol (the former to reduce the solvolysis effect of the latter) is useful for many acids. The titrant may be a solution of sodium or potassium methoxide in benzene-methanol; the sharpest end points are obtained when the minimum amount of methanol necessary to produce a clear solution (say, 1 volume of methanol to 6 or 10 volumes of benzene for sodium methoxide and potassium methoxide respectively) is used.

For the titration of all except very weak organic acids, dimethylformamide is a valuable solvent. Very weak acids (*e.g.*, many phenols) usually require a more strongly basic solvent, such as anhydrous ethylenediamine or *n*-butylamine (reasonable satisfactory results can, however, often be obtained with dimethylformamide as solvent); these solvents exert a levelling effect and enhance the acidic strengths of weak acids sufficiently to permit titration with sodium methoxide in benzene-methanol using a visual indicator. Both ethylenediamine and *n*-butylamine absorb carbon dioxide from the atmosphere readily; precautions must therefore be taken to avoid errors from this source.

Solutions of quaternary ammonium hydroxides in organic solvents, *e.g.* tetra-*n*-butylammonium hydroxide in benzene-methanol or in *isopropanol* or of triethyl-*n*-butylammonium hydroxide in benzene-methanol, are valuable titrants for a large variety of organic acids. They possess important advantages: the tetraalkylammonium salts of most weak organic acids are more soluble in the organic solvents commonly employed than are the corresponding potassium or sodium salts, thus difficulties due to

precipitation are minimised: the glass electrode can be used without loss in sensitivity in the highly alkaline regions which are encountered in titrants containing potassium or sodium. The titrant is prepared by shaking a solution of the tetra-alkyl ammonium iodide in methanol with a suspension of silver oxide, the excess of silver oxide is filtered off, and the filtrate is diluted to the desired volume with benzene. Alternatively, a saturated solution of the tetra-alkylammonium iodide in *isopropanol* is passed through a large anion exchange column in the —OH form.

**Potentiometric titration.** The electrode systems employed in the potentiometric titration of acids, using potassium methoxide or sodium methoxide in benzene-methanol as titrants, vary with the solvent employed. The conventional glass - calomel electrode systems may be used for titration in alcohol or in acetonitrile solutions. For benzene - methanol solutions, a glass electrode and an antimony electrode give fairly satisfactory results for many organic acids: the glass electrode appears to function as the reference electrode and the antimony as the indicator electrode. The antimony - calomel pair may also be used: lithium chloride may be added to the solution to increase the conductivity, and also the electrodes should be placed as close together as possible.

Titration in basic solvents (dimethylformamide, ethylenediamine and *n*-butylamine) may be made with the antimony - glass electrode system. Antimony - calomel electrodes have been used for titration in dimethylformamide and antimony - antimony electrode pairs for ethylenediamine.

When titrations are performed with solutions of tetra-alkylammonium hydroxides in benzene - methanol or benzene - *isopropanol* as the titrant and methyl ethyl ketone, acetonitrile or pyridine as solvents, the conventional glass - calomel electrode system may be used. The antimony - calomel electrode system is applicable in pyridine and in dimethylformamide.

**Indicators.** The following indicators find application in titrations performed with potassium methoxide, sodium methoxide or tetra-alkylammonium hydroxides in benzene - methanol.

*Thymol blue* (0.3 per cent. w/v in methanol). The colour change is from yellow to blue. It may be used for titrations in benzene, acetonitrile, pyridine, dimethylformamide or *n*-butylamine, but not in ethylenediamine.

*Azo violet* (*p*-nitrobenzene-azo-resorcinol; 0.1 per cent. solution in benzene). This is a less acidic indicator than thymol blue. The colour change is from red to blue. The indicator gives sharp end points in basic solvents such as pyridine, dimethylformamide, ethylenediamine and *n*-butylamine; it is not satisfactory for benzene (or other hydrocarbon) solutions.



*o*-Nitroaniline (0.15 per cent. solution in benzene) is a still weaker indicator. The colour change is from yellow to orange-red. It may be used for the titration of phenols and very weak acids in ethylenediamine and may also be applied in dimethylformamide; it does not appear to function in alcohol, benzene and *n*-butylamine.

**Apparatus.** For many purposes a 50 ml. or 100 ml. beaker will suffice and mixing may be effected by means of a magnetic stirrer. The electrodes are supported in suitable clamps over the beaker (compare Fig. XV, 4, 3). If the solvent absorbs carbon dioxide from the atmosphere, the electrodes and the tip of the burette may be inserted through holes in a sheet of cardboard covering the beaker: an alternative arrangement is to use a three- or four-necked flask.

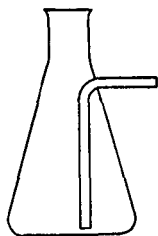

Fig. XV, 5, 1.

A visual titration may be effected in a small beaker. Alternatively, a conical flask (50 or 100 ml.) with a gas inlet tube sealed into the side wall (Fig. XV, 5, 1) may be used; stirring may be effected with the aid of a slow stream of nitrogen. For basic solvents, absorption of carbon dioxide may be minimised by insertion

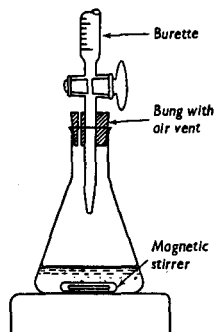

Fig. XV, 5, 2.

of the burette tip through a hole in a cork which is loosely inserted into the neck of the conical flask; a better arrangement is to have a vent in the cork supporting the burette (Fig. XV, 5, 2).

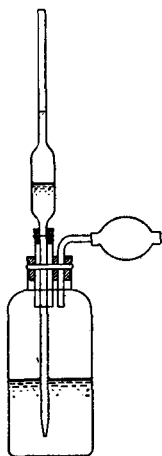

Fig. XV, 5, 3.

Solutions of solvents, the vapours of which are toxic, should be measured out with an automatic pipette. A simple type of automatic pipette is depicted in Fig. XV, 5, 3. Better control may be achieved by means of a device known as a "Pumpett"\* (Fig. XV, 5, 4). The latter is really a mechanical apparatus for filling and emptying pipettes. In addition to the large rubber bulb at the upper end, a pair of internal micro bulbs are incorporated which give fine control of the rate of discharge. The device accommodates

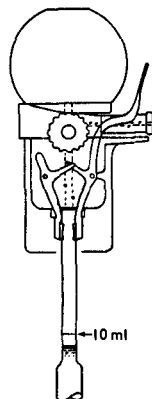

Fig. XV, 5, 4.

\* Supplied by Shandon Scientific Co. Ltd., 6 Cromwell Place, London, S.W.7. The "Propipette" is similar in principle, but the rubber bulb cannot be replaced.

all sizes of pipettes; these are positively clamped and instantaneously released by a lever-operated, spring-loaded two jaw chuck.

The "Pumpett" consists of an acid-resistant moulded plastic body surrounded by a surgical grade rubber operating bulb. This body houses the stainless steel mechanism which operates the rubber-lined chuck jaws (which grip the pipette), the coarse air control valve and the micro control. Full instructions for operating the instrument are supplied by the manufacturers.

The eye in visual titrations may be replaced by a photo-cell to measure the intensity of coloration. The photo-cell is far more

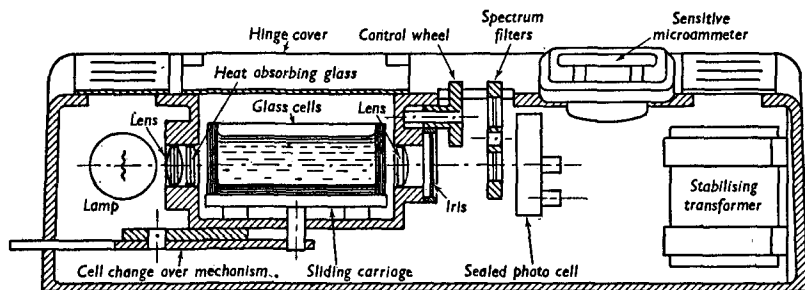

Fig. XV, 5, 5.

sensitive than the human eye and furthermore it permits the elimination of the human element in titrations dependent upon changes in colour. A suitable commercial instrument is the "EEL" colorimeter\* illustrated in Figs. XV, 5, 5 and XV, 5, 6. It is recommended that a thin wooden stand (with a circular

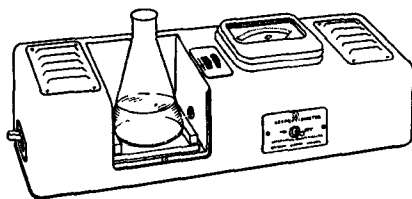

Fig. XV, 5, 6.

opening to accommodate a 100 or a 250 ml. conical flask) be fitted into the cell compartment; this will ensure that the flask is always returned to the same position after being somewhat displaced when the contents of the flask are shaken for mixing. A series of colour filters, easily inserted into the light path by means of a "colour filter wheel", is provided. Readings are made on a micro-ammeter with a 4" scale.

\* Supplied by Evans Electro-selenium Ltd., Harlow, Essex, England.

## CHAPTER XVI

### HYDROXYL GROUPS (ALCOHOLS)

#### XVI.1. DISCUSSION OF SELECTED METHODS FOR THE DETERMINATION OF HYDROXYL GROUPS IN ALCOHOLS

The procedures commonly used for the determination of hydroxyl groups in alcohols include acetylation, phthalation and oxidation with periodates. The last-named method is applied to polyhydric alcohols containing adjacent hydroxyl groups and is described fully in Chapter XVII.

The acetylation method involves the replacement of the hydrogen on an alcoholic hydroxyl group by acetyl. The reagent consists of a solution of acetic anhydride in pure pyridine and is used in excess :

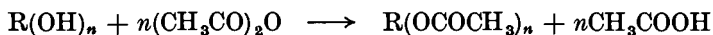

The addition of water converts the excess of acetic anhydride into acetic acid, the total free acetic acid is then titrated with standard sodium hydroxide solution :



A control or blank experiment is performed simultaneously identical with the above except that the addition of the hydroxy compound is omitted. The difference in the volumes of sodium hydroxide solution required in the two experiments is equivalent to the difference in the amount of acetic acid formed, *i.e.*, to the acetic acid derived from the acetic anhydride consumed in the actual acetylation of the sample. If the molecular weight of the compound is known, the number of hydroxyl groups in the compound can be calculated.

The advantages of control or **blank determinations**\* are twofold :

(i) The absolute concentration of the reagent (here the exact concentration of acetic anhydride in the pyridine solution) need not be determined. If the same volume of reagent is used in the actual and in the blank experiment, the *difference* gives the actual amount used.

(ii) Indeterminate losses of the reagent (due to slight chemical action of the glass vessels, slight absorption by the corks, etc.) are almost identical in the actual and blank experiments and therefore do not affect the *difference* in result between the two experiments.

\* These are often described as "running a blank" on a reagent, etc.

It may be mentioned that pyridine is used as a solvent in acylations because it is inactive towards the reagents, it removes the acid products by salt formation, and it also serves as a catalyst.

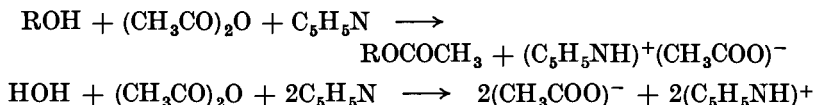

The phthalation method is essentially similar to that of acetylation. The reagent is a solution of phthalic anhydride in pyridine :

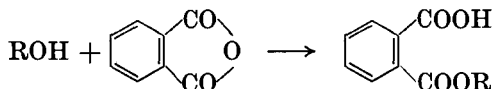

The acetylation procedure is more rapid than phthalation ; a larger excess of phthalic anhydride is therefore needed for complete reaction. Primary and many secondary amines are acetylated by the acetic anhydride - pyridine reagent and indeed this provides a good method for the determination of amino groups (see Chapter XIX) ; phenols are also acetylated (see Chapter XVIII) but not phthalated, so that alcohols can be determined in the presence of phenols. Aldehydes of low molecular weight appear to interfere with the acetic anhydride procedure but not in the phthalic anhydride method. Neither procedure can be used with tertiary alcohols because the alcohol is dehydrated.

## XVI,2. DETERMINATION OF ALCOHOLIC HYDROXYL GROUPS BY ACETYLATION WITH ACETIC ANHYDRIDE IN PYRIDINE

### REAGENTS

*Acetic anhydride in pyridine.* Mix one volume of acetic anhydride (analytical reagent grade) and three volumes of pure, dry pyridine as required. Transfer the mixture to a dry semimicro burette and insert a soda-lime guard tube into the top of the burette.

*Mixed indicator solution.* Mix one part of 0.1 per cent. aqueous cresol red neutralised with sodium hydroxide solution and three parts of 0.1 per cent. aqueous thymol blue neutralised with sodium hydroxide. The colour change is at a pH of about 9.8.

*Alcoholic sodium hydroxide solution, 0.5N.* Mix the required volume of saturated aqueous sodium hydroxide solution (about 18N ; prepared from the A.R.\* solid) with aldehyde-free ethanol or methanol in a 500 ml. volumetric flask. The methanolic solution is generally preferred because of its better keeping properties. Standardise the alcoholic alkali with A.R. potassium hydrogen phthalate or with standard 0.5N aqueous sulphuric acid, using the mixed indicator.

\* The abbreviation A.R. will be used for analytical reagent grade.

## PROCEDURE

Introduce an accurately weighed sample containing 1 to 2.5 milli-equivalents of the sample (e.g., *n*-hexanol, *n*-octanol, cello-solve, butyl cellosolve, cyclohexanol, benzyl alcohol, mannitol or glucose) into a 250 ml. iodine flask (Fig. XVI, 2, 1) and add 3.00 ml. of the acetylating reagent. Moisten the glass stopper with pyridine and seat it loosely. Heat the flask on a steam bath for 45 minutes. Add 5–6 ml. of water to the cup around the stopper, loosen the stopper so that the water rinses down the stopper and the walls of the flask. Swirl the contents of the flask to ensure thorough mixing. Heat for 2 minutes more. Cool the flask under running water or in ice, with the stopper partially open. Rinse the stopper and the sides of the flask with 5–10 ml.

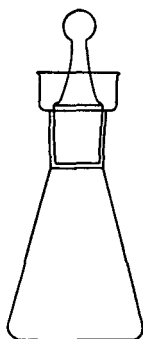

Fig. XVI, 2, 1.

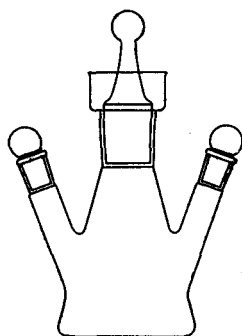

Fig. XVI, 2, 2.

of *n*-butanol, add a few drops of the mixed indicator, and titrate the contents with 0.5*N* alcoholic sodium hydroxide (1) to a grey colour.

Make a blank determination on 3.00 ml. of the reagent simultaneously and similar in all respects except for the addition of the sample. The difference between the volumes of alkali used in the two titrations corresponds to the alcohol which has reacted (2).

## Notes.

(1) Compounds which yield highly coloured solutions can be titrated potentiometrically by the use of a *pH* meter with glass and calomel electrodes to a *pH* of 9.8. (The vertical portion of the titration curve lies between 9.2 and 10.3.) The titration is conveniently effected in an iodine flask modified by sealing into it two side arms which can be closed with ground-glass stoppers (see Fig. XVI, 2, 2): the electrodes are inserted through the side arms.

(2) Any free acid in the sample should be determined by dissolving a suitable weight of the sample in 5 ml. of pyridine, adding 5 ml. of neutral ethyl alcohol or *n*-butyl alcohol, and titrating with the standard alkali with the aid of the mixed indicator. A correction must be applied for the free acid present.

## CALCULATION

Calculate the percentage of hydroxyl in the sample from the formula :

$$\% \text{ OH} = \frac{(V_1 - V_2) \times N_1 \times 17.01 \times 100}{W \times 1000}$$

where  $V_1$  = volume (ml.) of sodium hydroxide solution used in blank;

$V_2$  = volume (ml.) of sodium hydroxide solution used for sample ;

$N_1$  = normality of alkali ; and

$W$  = weight (g.) of sample.

### XVI,3. DETERMINATION OF ALCOHOLIC HYDROXYL GROUPS BY PHTHALATION WITH PHTHALIC ANHYDRIDE IN PYRIDINE

#### REAGENTS

*Phthalic anhydride in pyridine, 1M.* Dissolve 15 g. of the purest available phthalic anhydride in 100 ml. of pure, dry pyridine. The anhydride should be acid-free (see Sections XXIV,1-2 for a procedure for the determination of the anhydride content).

*Aqueous sodium hydroxide, 0.5N.* This is prepared from A.R. sodium hydroxide pellets and standardised either with A.R. potassium hydrogen phthalate or with standard 0.5N aqueous sulphuric acid, using phenolphthalein as indicator.

*Phenolphthalein indicator.* See Section XXII,2.

#### PROCEDURE

Weigh out accurately a sample containing about 10 milliequivalents of hydroxyl into a 250 ml. iodine flask and introduce 50.0 ml. of the reagent. Moisten the glass stopper with pyridine and seat it loosely : heat on a steam bath for 1 hour. Add 5-6 ml. of water to the cup around the stopper, loosen the stopper so that the water runs down the stopper and the walls of the flask. Swirl the contents of the flask to ensure thorough mixing. Heat the flask for a further 4-5 minutes. Cool the flask to room temperature with the stopper partially open. Rinse the stopper with a further 5 ml. of water and add a few drops of phenolphthalein indicator. Titrate the contents with the standard 0.5N sodium hydroxide.

Conduct a blank determination on the phthalic anhydride reagent simultaneously : this should be similar in all respects except for the addition of the sample.

#### CALCULATION

Calculate the percentage of hydroxyl in the sample from the formula :

$$\% \text{ OH} = \frac{(V_1 - V_2) \times N_1 \times 17.01 \times 100}{W \times 1000}$$

(for significance of symbols, see Section XVI,2).

## CHAPTER XVII

### ADJACENT HYDROXYL GROUPS (POLYHYDRIC ALCOHOLS). PERIODATE TITRATIONS

#### XVII.1. THE MALAPRADE REACTION AND ITS APPLICATION TO THE DETERMINATION OF POLYHYDRIC ALCOHOLS

##### THEORY

Malaprade (1928) found that compounds containing hydroxyl groups attached to adjacent carbon atoms are oxidised quantitatively at ordinary temperatures by excess of periodic acid or its salts according to the following scheme :

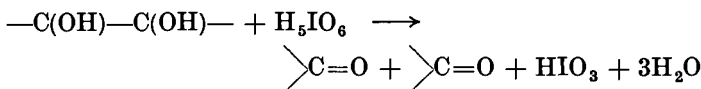

The nature of the other radicals attached to the carbon atoms bearing the hydroxyl groups will clearly have some influence upon the reaction, but our immediate concern is with the polyhydric alcohols for which the general reaction may be written as :

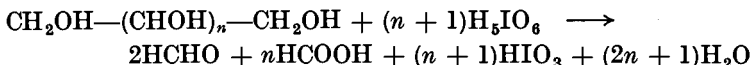

The reactions for ethylene glycol and for glycerol are respectively :

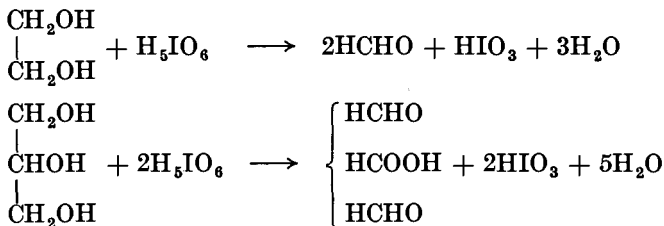

It will be noted that, if we regard periodic acid as a monobasic acid, glycerol reacts with two equivalents of the acid to give one equivalent of formic acid and two equivalents of iodic acid, whilst ethylene glycol yields only one equivalent of iodic acid. If the total acid is determined acidimetrically to a methyl red end point, and the iodic acid and excess of periodic acid is evaluated iodometrically, the analysis of both glycerol and ethylene glycol in a mixture can be made. The potentiometric titration curve of a solution of periodic acid ( $\text{H}_5\text{IO}_6$ ) and standard sodium hydroxide solution reveals that the first hydrogen atom is neutralised at a pH of about 10.0, but the inflection at the second equivalence

point is not very sharp. Methyl red indicator may be used as a visual indicator for the neutralisation of the first hydrogen atom.

The iodometric procedure makes use of the different reactions of periodic acid and iodic acid with acidified potassium iodide solution :

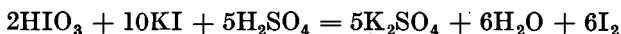
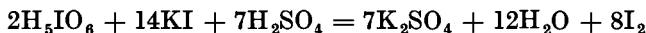

Since for every molecule of periodic acid consumed in the Malaprade reaction one molecule of iodic acid is produced,

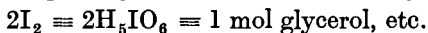
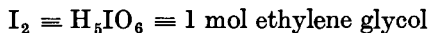

The value of  $n\text{I}_2$  is obtained from the difference in the thiosulphate titre of the blank and the reaction product after the addition of excess of acidified potassium iodide solution. This is the basis of the iodometric method and enables the purity of individual polyhydric alcohols to be determined. It may also be applied to polyhydroxy acids, such as tartaric acid.

The acidimetric procedure utilises the fact that the neutralisation of the second hydrogen atom in periodic acid may be detected by titration at about  $0^\circ \text{C}$ . with a mixed indicator (thymolphthalein and 1-naphtholbenzein in alcohol).

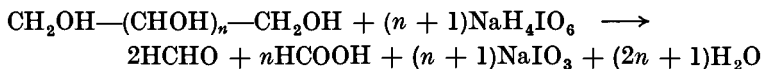
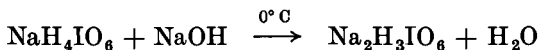
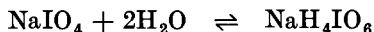

With straight chain glycols higher than ethylene glycol, formic acid is produced : this will, of course, be included in the titration of the excess of periodate. The acidity due to formic acid can be measured and corrected by a separate determination. This independent determination with standard sodium hydroxide solution is made in the presence of methyl red indicator at room temperature : the excess of  $\text{NaH}_4\text{IO}_6$  present in the solution is neutral to this indicator.

## XVII,2. DETERMINATION OF POLYHYDRIC ALCOHOLS—IODOMETRIC PROCEDURE

### REAGENTS

*Periodic acid solution*, ca.  $0.05\text{N}$  as monobasic acid. Dissolve  $5.5 \text{ g}$ . of pure periodic acid in distilled water, and dilute with distilled water to  $500 \text{ ml}$ . Filter through a sintered glass funnel, if necessary. Store



the solution in a dark glass bottle with a glass stopper. This solution decreases slowly in oxidising power and must be standardised daily.

*Sodium thiosulphate solution, ca. 0.2N.* Dissolve 25 g. of A.R. sodium thiosulphate pentahydrate in 500 ml. of freshly-boiled and cooled distilled water. Standardise the solution with pure potassium iodate.

*Starch indicator solution.* Make a paste of 1.0 g. of soluble starch with a little water and pour the suspension, with constant stirring, into 100 ml. of boiling water. Boil the mixture for 1 minute, allow to cool, and add 3 g. of potassium iodide. Transfer the solution to a stoppered bottle.

*Potassium iodide solution, 20 per cent.* Dissolve 100 g. of A.R. potassium iodide in 400 ml. of distilled water.

### PROCEDURE

In order to ensure the necessary excess of periodic acid, the sodium thiosulphate solution consumed by the sample should not be greater than one-fifth that required by the blank.

**Ethylene glycol.** Weigh out accurately about 1.2 g. of ethylene glycol, dissolve it in water and make up to 250 ml. in a volumetric flask. Transfer 25.0 ml. of this solution to a 500 ml. iodine flask, add 50.0 ml. of the periodic acid solution by means of a pipette, mix the solutions well and allow to stand for 30–40 minutes. Add 30 ml. of 20 per cent. potassium iodide solution, followed by 25 ml. of 6*N* sulphuric acid. Titrate the solution with the 0.2*N* sodium thiosulphate to a pale yellow colour, then add 2 ml. of the starch indicator solution, and continue the titration to the disappearance of the starch-iodine colour.

Carry out a blank titration using 50.0 ml. of the periodic acid solution.

Calculate the purity of the sample of ethylene glycol.

**Glycerol.** Weigh out accurately about 0.9 g. of the sample of glycerol, dissolve it in water and dilute to 250 ml. in a volumetric flask. To 25.0 of the glycerol solution in a 500 ml. iodine flask, add 50.0 ml. of the periodic acid reagent, mix, and allow to stand for 60–80 minutes. Complete the titration as for ethylene glycol. Perform a blank titration using 50.0 ml. of the periodic acid solution.

Calculate the percentage of glycerol in the sample.

**D-Glucose (dextrose).** Prepare a solution of about 1.2 g. (accurately weighed) of the sample of dextrose in 250 ml. of water in a volumetric flask. Mix 25.0 ml. of the dextrose solution and 50.0 ml. of the periodic acid reagent, allow the solution to stand for 80 minutes, and complete the titration as described for ethylene glycol. Run a blank on 50.0 ml. of the periodic acid reagent.

Calculate the percentage of dextrose in the sample.

**Mannitol.** Weigh out accurately about 0.8 g. of mannitol, dissolve it in water and dilute to 250 ml. in a volumetric flask. Use 25.0 ml. of the mannitol solution and 50.0 ml. of the periodic acid reagent for each titration, and allow to stand for 80 minutes. Run a blank on 50.0 ml. of the periodic acid reagent.

Calculate the percentage of mannitol in the sample.

**D-Tartaric acid.** Proceed exactly as described for ethylene glycol. Prepare the stock solution by dissolving 1.1 g., accurately weighed, of D-tartaric acid in water and diluting to 250 ml. in a volumetric flask. Allow 25.0 ml. of this solution and 50.0 ml. of the periodic acid reagent to stand for 90 minutes, and complete the titration as for ethylene glycol. Run a blank on 50.0 ml. of the periodic acid reagent.

Calculate the percentage of D-tartaric acid in the sample.

### CALCULATION

If 1 mol of the polyhydric alcohol requires  $Z$  mols of periodic acid,  $W$  g. of the sample of molecular weight  $M$  will require

$$\begin{aligned} & W \times Z/M \text{ mols of periodic acid} \\ \text{or } & W \times Z \times 2000/M \text{ ml. of } N \text{ iodine} \\ \equiv & W \times Z \times 2000/(M \times N_1) \text{ of thiosulphate solution of normality } N_1 \end{aligned}$$

If  $A = (\text{Ml. for blank} - \text{Ml. for sample of weight } W)$  of thiosulphate solution of normality  $N_1$ ,

% Polyhydric alcohol

$$\begin{aligned} &= \frac{\text{Obs. volume of thiosulphate solution} \times 100}{\text{Calc. volume of thiosulphate solution}} \\ &= \frac{A \times M \times N_1 \times 100}{W \times Z \times 2000} \end{aligned}$$

## XVII.3. DETERMINATION OF POLYHYDRIC ALCOHOLS—ACIDIMETRIC PROCEDURE

### REAGENTS

*Sodium metaperiodate solution.* Prepare a 0.1M solution by dissolving 10.70 g. of pure sodium metaperiodate  $\text{NaIO}_4$  in 500 ml. of distilled water in a volumetric flask. Do not use heat to aid solution; if the periodate does not dissolve at room temperature, it is unsatisfactory.

*Sodium hydroxide solution.* Prepare a standard 0.1N solution; it should be free of carbonate.

*Mixed indicator solution.* This consists of 0.2 per cent. thymolphthalein and 0.1 per cent.  $\alpha$ -naphthol-benzoin in 90 per cent. ethyl alcohol.

## PROCEDURE

**Ethylene Glycol.** Weigh out accurately about 1.2 g. of the sample of ethylene glycol, dissolve it in water, and dilute to 250 ml. in a volumetric flask. Transfer 50.0 ml. of this solution to a 500 ml. iodine flask by means of a pipette, add 50.0 ml. of the sodium metaperiodate solution, mix well by gentle swirling of the solution, and allow to stand for 30 minutes. Now add excess of washed crushed ice in order to keep the temperature below 1° C. during the titration. Titrate with the standard 0.1*N* sodium hydroxide solution in the presence of 2 ml. of the mixed indicator; the end point colour change is from yellow to grey-blue when viewed against a white background. Carry out a blank determination with 50.0 ml. of the sodium periodate solution and omitting the standing period.

Calculate the percentage of ethylene glycol in the sample.

**Mannitol.** Weigh out accurately about 0.8 g. of the sample of mannitol, dissolve it in water and dilute to 250 ml. in a volumetric flask. Use 50.0 ml. of this solution for oxidation with 50.0 ml. of the sodium metaperiodate solution as detailed for ethylene glycol: titrate at 0° C. with standard 0.1*N* sodium hydroxide, using the mixed indicator.

Carry out a further titration with 50 ml. of the mannitol solution and 50 ml. of the periodate solution, allow to stand for 30 minutes, and titrate at room temperature with 0.1*N* sodium hydroxide, using methyl red as indicator.

Perform a blank determination with 50.0 ml. of the sodium metaperiodate solution and omitting the standing period.

Calculate the percentage of mannitol in the sample using the formula deduced below.

## CALCULATION

For ethylene glycol :

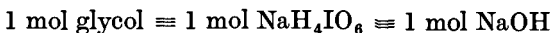

If 1 mol of polyhydric alcohol requires *Z* mols of sodium periodate (NaIO<sub>4</sub> or NaH<sub>4</sub>IO<sub>6</sub>)  $\equiv Z \times 1000$  ml. of *N* NaOH,

*W* g. of the sample of molecular weight *M* will require :

$$W \times Z \times 1000/M \text{ ml. of } N \text{ NaOH}$$

If *A* = (Ml. for blank - Ml. for sample of weight *W*) of NaOH of normality *N*<sub>1</sub>,

*W* g. of compound  $\equiv A$  ml. of *N*<sub>1</sub> NaOH

$$\equiv \frac{W \times Z \times 1000}{M \times N_1} \text{ ml. of } N_1 \text{ NaOH}$$

$$\begin{aligned} \therefore \quad \% \text{ Purity} &= \frac{\text{Obs. volume of } N_1 \text{ NaOH} \times 100}{\text{Calc. volume of } N_1 \text{ NaOH}} \\ &= \frac{A \times M \times N_1 \times 100}{W \times Z \times 1000} \end{aligned}$$

With glycols other than ethylene glycol, formic acid is also produced. If  $B$  ml. of NaOH of normality  $N_1$  is required to neutralise the formic acid produced from the sample (50 ml. of the solution of the polyhydroxy compound), the volume of periodate solution consumed will be equivalent to  $(A + B)$  ml. of  $N_1$  NaOH,

$$\therefore \quad \% \text{ Purity} = \frac{(A + B) \times M \times N_1 \times 100}{W \times Z \times 1000}$$

## CHAPTER XVIII

### HYDROXYL GROUPS (PHENOLS)

#### XVIII,1. DISCUSSION OF SELECTED METHODS FOR THE DETERMINATION OF HYDROXYL GROUPS IN PHENOLS

The following general methods may be used :—

(a) Acetylation with a solution of acetic anhydride in pyridine:



The procedure is similar to that described for the acetylation of alcohols (Sections XVI,1-2).

(b) Bromination with excess of a standard bromate-bromide solution in the presence of hydrochloric acid :

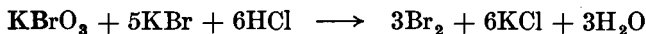

The excess of bromine is determined by the addition of potassium iodide solution and titration of the liberated iodine with standard sodium thiosulphate solution :

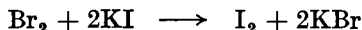

The variables in the bromination procedure include temperature, excess of bromine, and time of reaction. The best results are obtained at room temperature or below since bromination of side chains under these conditions is usually very slow : the excess of bromine must be controlled in order to reduce side chain bromination.

Phenol yields 2 : 4 : 6-tribromophenol :

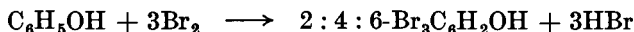

The presence of halogen or of nitro groups in the *ortho* and *para* positions does not hinder the bromination. Hydroxyl or amino groups in the *ortho* and *para* positions hinder the entrance of bromine into the ring. Carboxyl and sulphonic acid groups seem to behave in an intermediate manner, a dibromo product is first formed : upon standing with excess of bromine, the tribromo derivative is produced with the elimination of the carboxyl or sulphonic acid group—thus salicylic acid yields 2 : 4 : 6-tribromophenol.

An average bromination period is 30 minutes using about 100 per cent. excess of bromine. The number of bromine atoms consumed for some typical phenols is given in parentheses : phenol (6) ; *p*-chlorophenol (4) ; *o*- or *p*-nitrophenol (4) ; *m*-nitrophenol (6) ; 2 : 4-dinitrophenol (2) ; *m*-cresol (6) ; resorcinol (6) ;  $\beta$ -naphthol (2) ; salicylic acid (6) ; *m*-hydroxybenzoic acid (6) ; methyl salicylate (6) ; phenyl

salicylate (12), and acetylsalicylic acid (6). The esters of salicylic acid must be hydrolysed with dilute alkali before bromination.

(c) By titration as acids in non-aqueous solvents. Phenols may be regarded as very weak acids and, indeed, very few are strong enough to be titrated in an aqueous medium. Titrations must therefore be carried out in a non-aqueous basic solvent so that the apparent acidity is enhanced (see Section XV,5). The titrant is a solution of sodium methoxide or potassium methoxide in benzene-methanol. Suitable solvents are dimethylformamide, ethylenediamine and *n*-butylamine; the last two solvents absorb carbon dioxide from the atmosphere so that exposure of the solution should be reduced to a minimum. Visual indicators, such as azo violet or *o*-nitroaniline, can often be used. The end point can usually be determined potentiometrically, using antimony and glass electrodes; the antimony electrode is the indicator electrode. The antimony and calomel electrodes may sometimes be used for titrations in dimethylformamide.

A 0.1*N* solution of sodium aminoethoxide in ethylenediamine may also be employed as titrant in ethylenediamine: a fairly satisfactory end point in the titration with most phenols can be obtained by potentiometric titration using a commercial *pH* meter and either a glass and antimony electrode system or two antimony electrodes (one of which has the surface roughened by rubbing with a clean file).

The 0.1*N* sodium aminoethoxide is prepared as follows. Dry monoethanolamine, b.p. 171°, is obtained by fractionation of the commercial product through an efficient fractionating column. Wash 2.5 g. of clean sodium with a little absolute ethanol and ethylenediamine. Dissolve the sodium in 100 ml. of ethanolamine contained in a flask fitted with a reflux condenser, and cool momentarily if necessary to moderate the vigour of the reaction. Dilute to 500 ml. with ethylenediamine. Keep the solution in a Pyrex bottle provided with a soda-lime guard tube. Standardise with a solution of A.R. benzoic acid in ethylenediamine: determine the end point by potentiometric titration.

Phenols with negative substituents ( $-\text{CHO}$ ,  $-\text{COR}$ ,  $-\text{COOR}$ ,  $-\text{CONH}_2$  and  $-\text{NO}_2$ ) in the *ortho* and *para* positions and also with halogens in the *ortho* position are more acidic than phenol itself. These may conveniently be titrated in dimethylformamide with azo violet as indicator. For weaker phenols, such as phenol, the naphthols, and alkyl- and aryl-substituted phenols, ethylenediamine is the preferred solvent with *o*-nitroaniline as indicator. With such weak phenols, the amount of methanol present in the titrant must be minimised; since potassium methoxide requires a lower ratio of methanol to benzene in the reagent than does sodium methoxide, the former titrant is often advantageous.

The 0.1*N* potassium methoxide in benzene-methanol is prepared as follows. Dissolve about 2.0 g. of clean potassium (CAUTION in handling it!) in 10 ml. of dry methanol and 25 ml. of dry benzene

contained in a 500 ml. flask fitted with a reflux condenser : if necessary, cool the flask momentarily in cold water to prevent the reaction becoming too violent. When all the potassium has reacted, add methanol until the solution is homogeneous, followed by benzene until the solution becomes cloudy, then more methyl alcohol until the solution clears again. Repeat the dilution procedure until 500 ml. of clear solution is obtained. Store the solution in a Pyrex glass bottle provided with a soda-lime guard tube to prevent entry of carbon dioxide. Standardise the solution daily with A.R. benzoic acid dissolved in benzene - methanol ; thymol blue may be used as indicator.

Phenols may also be titrated potentiometrically in pyridine, acetonitrile or methyl ethyl ketone with a solution of a tetra-alkylammonium hydroxide in benzene - methanol. The conventional glass - calomel electrode system is satisfactory : it is advantageous to replace the saturated aqueous potassium chloride solution in the outer jacket of the calomel electrode by a saturated solution of potassium chloride in methanol. For titrations in pyridine, azo violet may be employed as a visual indicator. The solvents may possess acid impurities, consequently a blank titration is necessary.

The solution of *ca. 0.1N tetra-n-butylammonium hydroxide in benzene - methanol* may be prepared as follows. Use pure commercial tetra-*n*-butylammonium iodide, or prepare it by refluxing tri-*n*-butylamine and *n*-butyl iodide and recrystallise the product from benzene. Dissolve 20 g. of tetra-*n*-butylammonium iodide in 45 ml. of absolute methanol, add 10 g. of finely-ground, purified silver oxide, stopper the flask and agitate vigorously for 1.5 hours. Centrifuge a few ml. of the mixture and test the supernatant liquid for iodide. If the test is positive, add 1 g. more of silver oxide, and re-agitate for 30 minutes. If the test is negative, filter through a sintered glass funnel of fine porosity (preferably under nitrogen), rinse the flask and funnel with three 25 ml. portions of dry benzene and add to the filtrate. Dilute the filtrate to 500 ml. with dry benzene. Store in a flask protected from carbon dioxide and moisture. Standardise with A.R. benzoic acid.

## XVIII.2. DETERMINATION OF PHENOLS BY ACETYLATION WITH ACETIC ANHYDRIDE IN PYRIDINE

### PROCEDURE

Prepare the reagents as described under Hydroxyl Groups (Alcohols) in Section XVI,2.

Weigh out accurately into a 250 ml. iodine flask sufficient of the sample (*e.g.*, phenol or  $\beta$ -naphthol) to contain 1 to 2.5 milliequivalents of hydroxyl, and add 3.00 ml. of the acetylating reagent. Complete the determination as detailed under Alcohols.

Phenolphthalein usually gives a satisfactory end point in the titration.

Perform a blank determination on 3.00 ml. of the acetic anhydride-pyridine reagent simultaneously and similar in all respects.

Calculate the percentage of hydroxyl in the sample (see Section XVI,2).

### XVIII,3. DETERMINATION OF PHENOLS BY BROMINATION

#### REAGENTS

*Potassium bromate-bromide solution, 0.2N.* Dissolve 5.567 g. of A.R. potassium bromate and 75 g. of pure potassium bromide in water, and dilute to 1 litre in a volumetric flask. (The large excess over 5 equivalents of potassium bromide serves to ensure the complete reduction of the bromate when the solution is acidified and also to increase the solvent power of the solution for free bromine.)

*Sodium thiosulphate solution, 0.1N.* Dissolve about 25 g. of A.R. sodium thiosulphate pentahydrate in 1 litre of freshly-boiled and cooled distilled water. Standardise the solution with A.R. potassium iodate.

*Starch indicator solution.* See Section XVII,2.

*Potassium iodide solution, 20 per cent.* See Section XVII,2.

#### PROCEDURE

Weigh out accurately about 0.25 g. of the phenol, dissolve it in 5 ml. of 10 per cent. sodium hydroxide solution, and dilute the solution to 250 ml. in a volumetric flask. Pipette 25 ml. of the phenol solution into a 500 ml. iodine flask, followed by 25 ml. of the bromate-bromide solution, and then dilute with 25 ml. of water. Add 5 ml. of concentrated hydrochloric acid, and stopper the flask immediately. Shake the flask for 1 minute to mix the reactants, and allow to stand for 30 minutes with occasional swirling of the contents of the flask. Cool the flask under the tap or in ice water, place 10 ml. of 20 per cent. potassium iodide solution in the cup around the stopper. Slightly dislodge the stopper whereupon the iodide solution is drawn into the flask with no loss of bromine. Shake the flask well for 30 seconds and allow to stand for 10 minutes (1). Remove the stopper and wash the neck of the flask and the stopper with a little water. Titrate the free iodine, which is equivalent to the excess of bromine taken, with 0.1N sodium thiosulphate; add about 1 ml. of starch solution near the end point.

Carry out a blank analysis, using 25 ml. of the bromate-bromide reagent and 25 ml. of water, the procedure being otherwise identical with the analysis proper.



**Note.**

(1) The precipitate formed with phenol may contain, in addition to tribromophenol, some tribromophenol bromide :



This is of no consequence, as it is converted into tribromophenol when potassium iodide is added to the acid solution :

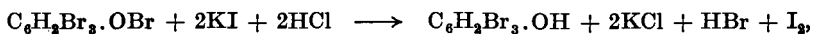

the extra bromine thus combined reacting as if it were free bromine. It is advisable to allow the solution to stand for 5–10 minutes in the presence of potassium iodide solution to ensure that all the tribromophenol bromide is decomposed.

It may be noted that the simple procedure given above is not applicable to  $\beta$ -naphthol; the latter (about 0.75 g., accurately weighed) should be dissolved in 10 ml. of 10 per cent. sodium hydroxide solution and diluted to 250 ml. in a volumetric flask. For the titration, use 25 ml. of the  $\beta$ -naphthol solution, 25 ml. of the bromate-bromide solution and 15 ml. of chloroform; cool in ice for 5 minutes. Add 5 ml. of concentrated hydrochloric acid, stopper the flask, shake gently so that the brominated product dissolves in the chloroform, and cool in an ice bath for a further 5 minutes. Add 10 ml. of 20 per cent. potassium iodide solution, allow to stand for 10 minutes, and titrate with 0.1N sodium thiosulphate solution. Shake vigorously before the end point is reached as the chloroform tends to retain the last traces of iodine rather tenaciously. Perform a blank titration under the same conditions and thus compensate for the slight attack on the chloroform by the bromine.

**CALCULATION**

Calculate the percentage purity of the phenol from the expression :

$$\% \text{ Purity} = \frac{(V_1 - V_2) \times N_1 \times M \times 100}{W \times 2000 \times Z} \quad (1)$$

where  $V_1$  = ml. of sodium thiosulphate solution used for blank ;  
 $V_2$  = ml. of sodium thiosulphate solution used for sample ;  
 $N_1$  = normality of sodium thiosulphate solution ;  
 $M$  = molecular weight of the phenol ;  
 $W$  = weight (g.) of the sample ; and  
 $Z$  = number of bromine atoms substituted in the phenol.

Alternatively, the blank analysis may be omitted and the percentage purity of the phenol calculated from formula (2). The student is recommended to perform the blank titration and to calculate the result by both methods.

$$\% \text{ Purity} = \frac{(VN_2 - V_2N_1) \times M \times 100}{W \times 2000 \times Z} \quad (2)$$

where  $V$  = volume (ml.) of bromate solution used for the titration ;  
 $N_2$  = normality of bromate solution ;  
 $V_2$  = volume (ml.) of sodium thiosulphate solution used ;  
 $N_1$  = normality of sodium thiosulphate solution ;  
 $M$  = molecular weight of the phenol ;  
 $W$  = weight (g.) of sample ; and  
 $Z$  = number of bromine atoms substituted in the phenol.

Deduction of formula (2).

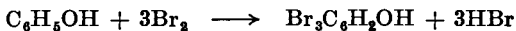
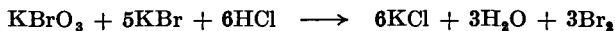

The volume of  $N$  bromate solution reacting with  $W$  g. of the sample is  $(VN_2 - V_2N_1)$  ml.

∴ Weight of bromine used by  $W$  g. of sample =  $(VN_2 - V_2N_1) \times 80/1000$  g.

∴ Weight of bromine used by  $M$  g. of sample =  $\frac{(VN_2 - V_2N_1) \times 80 \times M}{W \times 1000}$  g.

But 1 mol of pure phenol would react with 3 mols of bromine or  $6 \times 80$  g. of bromine,

$$\begin{aligned} \therefore \quad \% \text{ Purity} &= \frac{(VN_2 - V_2N_1) \times 80 \times M \times 100}{W \times 1000 \times 6 \times 80} \\ &= \frac{(VN_2 - V_2N_1) \times M \times 100}{W \times 2000 \times 3} \end{aligned}$$

For a phenol which reacts with  $Z$  mols of bromine :

$$\% \text{ Purity} = \frac{(VN_2 - V_2N_1) \times M \times 100}{W \times 2000 \times Z} \quad (2)$$

Equation (2) may be written in the form :

$$\% \text{ Purity} = \left( \frac{VN_2}{N_1} - V_2 \right) \times \frac{N_1 \times M \times 100}{W \times 2000 \times Z}$$

This is identical with equation (1),  $VN_2/N_1$  representing the theoretical value of the blank.

#### XVIII.4. DETERMINATION OF PHENOLS BY TITRATION AS ACIDS IN NON-AQUEOUS SOLVENTS

##### REAGENTS

*Sodium methoxide in methanol*, ca. 0.1N. Weigh out about 2.4 g. of freshly-cut, clean sodium metal and add it to 100 ml. of methanol contained in a 500 ml. flask fitted with a reflux condenser ; if necessary, cool the flask momentarily in cold water to prevent the reaction becoming too violent. When all the sodium has reacted, add benzene until the solution remains cloudy upon swirling ; add methanol and benzene alternately in this manner until the volume is 1 litre and the solution is clear. Store the solution in a Pyrex glass bottle provided with a soda-lime guard tube to prevent entry of carbon dioxide. Standardise the solution daily with A.R. benzoic acid dissolved in benzene-methanol and use thymol blue as indicator. The benzoic acid (about 0.25 g.) may also be dissolved in dimethylformamide (50 ml.). The standardisation may also be effected with pure *p*-aminobenzoic acid.

*Thymol blue indicator*. Dissolve 0.3 g. of thymol blue in 100 ml. of methanol. The colour change is from yellow to blue.

*o*-Nitroaniline indicator. Dissolve 0.15 g. of *o*-nitroaniline in 100 ml. of benzene. The colour change is from yellow to orange-red.

*Azo violet indicator.* Prepare a saturated solution of *p*-nitrobenzene-azo-resorcinol in benzene. The colour change is from red to blue.

*Dimethylformamide.* A grade of dimethylformamide (DMF) suitable for titration purposes is available commercially. This compound decomposes slightly at its normal boiling point (153° C.) to give small amounts of dimethylamine and carbon monoxide. The technical dimethylformamide may be purified by mixing it with about 10 per cent. by volume of sodium-dried benzene and distilling at atmospheric pressure to remove the benzene; the temperature does not rise above 80° C. and most of the water is removed in the benzene-water azeotrope. The resulting product is shaken mechanically for several hours with anhydrous magnesium sulphate previously heated at 300–400° C. (25 g. per litre), distilled at 15–20 mm. pressure through an efficient fractionating column and the middle fraction collected.

*Ethylenediamine.* A product suitable for titrations is available commercially; its purity is 95–100 per cent. It may be dried, if necessary, by warming with sodium hydroxide pellets, cooling to permit the facile separation of water, and then distilling from sodium.

## PROCEDURE

**Titration in dimethylformamide.** *Determination of the purity of vanillin.*

Place 25 ml. of dimethylformamide in a 250 ml. conical flask and add three drops of azo violet indicator. Stir the contents of the flask by means of a magnetic stirrer (Fig. XV, 5, 2). Run in the 0.1N sodium methoxide solution from a burette until the colour of the solution in the flask just changes from pink to blue; close the mouth of the flask by a small square of cardboard and insert the burette tip through a small hole in the cover. This preliminary titration serves to neutralise any acidic impurities in the dimethylformamide. An equivalent result is obtained by performing an independent blank titration.

Weigh out accurately about 0.35 g. of vanillin and dissolve it in the dimethylformamide. Add the 0.1N sodium methoxide solution until the pink colour of the solution changes to blue. The colour should persist for 30 seconds.

The end point may also be determined by potentiometric titration using antimony and glass electrodes (compare Fig. XV, 4, 3) and a commercial pH meter.

Calculate the purity of the vanillin from the relationship:

Percentage purity

$$= \frac{\text{Volume of NaOMe solution} \times \text{Normality} \times \text{Equivalent weight}^* \times 100}{\text{Weight of sample (g.)} \times 1000}$$

\* This is the equivalent weight of the vanillin.

**Titration in ethylenediamine.** *Determination of the purity of  $\beta$ -naphthol.*

Precautions must be taken to protect the solvent and the solution from carbon dioxide and moisture. Place 25 ml. of ethylenediamine in a 250 ml. conical flask and add 2-3 drops of *o*-nitroaniline indicator ; stir with a magnetic stirrer. Add 0.1*N* sodium methoxide solution until the colour of the solution just changes from yellow to orange red (compare Fig. XV, 5, 2) ; this will neutralise acidic impurities in the solvent. Immediately add an accurately weighed sample (about 0.20 g.) of  $\beta$ -naphthol, stir until dissolved, and titrate until the colour changes from yellow to orange red. A reference standard contained in a stoppered conical flask prepared from a known weak phenol and the theoretical volume of titrant may be helpful. Alternatively, the "EEL" absorptiometer (Fig. XV, 5, 6) may be used for detecting the colour change at the end point.

The end point may also be determined potentiometrically ; a 100 or 250 ml. three-necked flask should be used.

Calculate the purity of the  $\beta$ -naphthol.

CHAPTER XIX  
AMINO GROUPS

**XIX,1. DISCUSSION OF SELECTED  
METHODS FOR THE DETERMINATION OF  
AMINO GROUPS IN AMINES**

The following general methods may be used :—

(a) Acetylation at room temperature with an excess of a solution of acetic anhydride in pyridine :

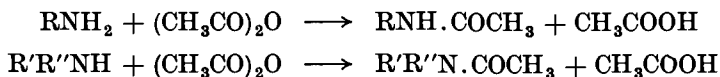

The residual excess of acetic anhydride is decomposed by the addition of water and the total free acid is determined with standard sodium hydroxide solution. A control or blank experiment is conducted simultaneously, identical with that used for the sample except that the addition of the amine is omitted. The procedure is similar to that described for the acetylation of alcohols and of phenols (Sections XVI,1-2 and XVIII,1-2).

The reactions are more accurately represented as follows :

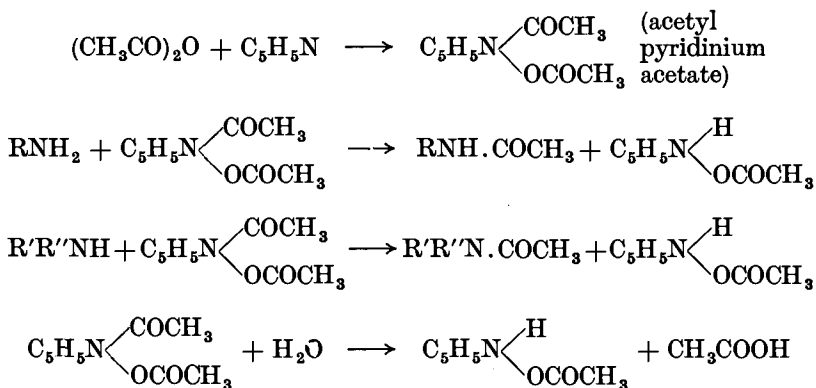

Acetylation is quantitative at room temperature if about 200 per cent. excess of acetic anhydride is used and the reaction mixture is allowed to stand for about 30 minutes.

With some primary amines, the presence of a group such as  $-\text{NO}_2$ ,  $-\text{CH}_3$  or  $-\text{Br}$  *ortho* to the amino group may lead to the formation of a diacetyl compound ; a check determination is therefore advisable if no detailed information is available. Diacetylation is favoured by high temperatures, hence the analysis is conducted at room temperature.

Satisfactory results have been obtained *inter alia* with ethylamine, *iso*-propylamine, *n*-butylamine, *n*-hexylamine, ethylenediamine, propylenediamine, diethylamine, di-*n*-butylamine, aniline,  $\alpha$ -naphthylamine, *N*-methylaniline (60 minutes standing), and morpholine.

(b) Bromination with excess of a standard bromate-bromide solution in the presence of hydrochloric acid :



The excess of bromine is determined by the addition of potassium iodide solution and titration of the liberated iodine with standard thiosulphate solution, using starch as indicator :

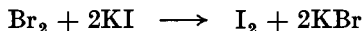

The procedure is similar to that described for Phenols (Section XVIII,3).

Aniline yields 2 : 4 : 6-tribromoaniline :

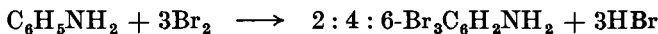

The number of bromine atoms consumed and the reaction times (in minutes) for some typical amines are given in parentheses : aniline (6 ; 5-10), *p*-chloroaniline (4 ; 10), *o*-nitroaniline (4 ; 30), *m*-nitroaniline (6 ; 30), acetanilide (6 ; 5-10), sulphanilic acid (6 ; 30), metanilic acid (6 ; 5-15), anthranilic acid (6 ; 30), *m*-aminobenzoic acid (6 ; 10-15), and *m*-toluidine (6 ; 5-10).

*o*- and *p*-Toluidines cannot be determined by the general procedure (excess bromine method) but give satisfactory results by the time-consuming **direct titration method**. The solution of the sample (prepared as for the other amines ; 25 ml.) is diluted to 200 ml., and 10 ml. of a 20 per cent. potassium bromide solution added. It is acidified with 5-10 ml. of concentrated hydrochloric acid and titrated with standard bromate solution (0.2*N*) until a drop of the solution produces a blue spot upon starch-iodide paper, which persists for 2 to 4 minutes after the addition of the last drop of bromate solution.

*p*-Nitroaniline cannot be determined by the bromination method, probably because of the occlusion of the sample in the bulky precipitate formed.

(c) By titration as bases, particularly in non-aqueous solutions. Many water-soluble aliphatic amines with dissociation constants greater than  $10^{-6}$  may be titrated in an aqueous medium with standard hydrochloric acid, using a mixed indicator (prepared by mixing 5 parts of 0.1 per cent. bromocresol green in methanol and 1 part of 0.1 per cent. methyl red in methanol) ; the end point may also be determined potentiometrically. Methanol may also be used as a solvent for amines having  $pK_b$  values (in water) of

ca. 8·8 or less ; a suitable indicator is prepared by dissolving 0·15 g. of methyl orange and 0·08 g. of xylene cyanol FF in 100 ml. of distilled water. Aromatic and other weakly basic amines cannot be titrated by either of the above procedures but if advantage is taken of the enhanced basicity of these compounds in glacial acetic acid (compare Section XV,4), these weak bases (including those with dissociation constants in water as low as  $10^{-13}$ ) can be successfully titrated in this solvent with a solution of perchloric acid in acetic acid.

The most general procedure, therefore, consists in the titration of amines as bases in non-aqueous solvents. The titrant, as already stated, is a solution of perchloric acid in acetic acid. The solvent is frequently glacial acetic acid since this medium tends to increase the basicity of the amine (levelling effect : Section XV,2). The end point may be determined either by visual indicator (crystal violet, methyl violet or  $\alpha$ -naphtholbenzein) or potentiometrically. Sharper end points can sometimes be obtained if the acetic acid solvent is diluted with an excess of a second solvent having a low dielectric constant, such as benzene or dioxan. Other solvents which have been used include benzene, chlorobenzene, nitrobenzene, acetonitrile and nitromethane. The glass-calomel electrode system is satisfactory if acetic acid is the only solvent used ; for other solvents (and also for acetic acid) the glass-silver/silver chloride electrode assembly is employed (see Section XV,4 for details of the silver/silver chloride electrode).

A procedure, which is now largely of academic interest, consists in the analysis of the chloroplatinate of the base, and gives either the equivalent weight or (if the acidity is known) the molecular weight of the base. It is included here because it provides valuable experience in semimicro quantitative analysis. When an amine or its halide salt is added to an aqueous solution of chloroplatinic acid  $H_2PtCl_6$ , the chloroplatinate of the base,  $(B_2H_2)PtCl_6$ , is formed (B is one equivalent of the base) ; it usually crystallises out because of its low solubility in cold water. The chloroplatinate of the base decomposes upon ignition leaving a residue of pure platinum. The molecular weight of the chloroplatinate and hence the equivalent B (the weight in grams equivalent to 1 gram atom of platinum), can be calculated from a knowledge of the platinum content of the salt. If the acidity of the base is known, its molecular weight can, of course, be evaluated.

Since many amines form highly crystalline picrates, the equivalent weights of such amines may be determined by titration of the picrate with acetous perchloric acid either visually or potentiometrically in an acetic acid medium : the picrate ion is a moderately strong base in this solvent.

## XIX,2. DETERMINATION OF AMINES BY ACETYLATION WITH ACETIC ANHYDRIDE IN PYRIDINE

### PROCEDURE

Prepare the reagents as described under Hydroxyl Groups (Alcohols) in Section XVI,2.

Introduce a weighed quantity containing about 2 milli-equivalents of the amine (1) (say, *ca.* 0.30 g., accurately weighed, of  $\alpha$ -naphthylamine) into a 250 ml. iodine flask and add 6.00 ml. of the acetic anhydride-pyridine reagent. Insert the stopper and allow to stand at room temperature with frequent gentle agitation. Cool the flask under tap water. Add 10 ml. of water to the cup around the stopper, loosen the stopper so that the water runs down the stopper and the walls of the flask. Swirl the contents of the flask to ensure thorough mixing. Cool the flask under running water or in ice, with the stopper partially open. Rinse the stopper and the sides of the flask with 10–15 ml. of *n*-butanol, add a few drops of the mixed indicator, and titrate immediately with the standard 0.5*N* alcoholic sodium hydroxide solution to the appearance of a definite blue colour. The acetyl derivative may remain in solution when water is added, but it frequently separates as a crystalline solid: the solid tends to remain suspended in the *n*-butanol layer and this facilitates the detection of the end point in the aqueous layer since the two phases readily separate after shaking.

Perform a blank determination using 6.00 ml. of the acetylating reagent simultaneously with the experiment on the sample.

#### Note.

(1) A suitable weight of the amine may be dissolved in pyridine and an aliquot used for the analysis. If desired, a known weight of the amine may be dissolved in 5–10 ml. of pyridine in the iodine flask.

### CALCULATION

Calculate the percentage of the amine group ( $\text{NH}_2$ ) in the sample from the formula :

$$\% \text{NH}_2 = \frac{(V_1 - V_2) \times N_1 \times 16.03 \times 100}{W \times 1000}$$

where  $V_1$  = volume (ml.) of sodium hydroxide solution used in the blank ;

$V_2$  = volume (ml.) of sodium hydroxide solution used for sample ;

$N_1$  = normality of sodium hydroxide solution ; and

$W$  = weight (g.) of the sample.



### XIX,3. DETERMINATION OF AMINES BY BROMINATION

#### PROCEDURE

Prepare the reagents as detailed under Hydroxyl Groups (Phenols) in Section XVIII,3. Weigh out accurately about 0.25 g. of the amine (*e.g.*, aniline) into a 250 ml. volumetric flask, dissolve the sample in the minimum volume of dilute hydrochloric acid, and dilute to the mark with distilled water. Pipette 25 ml. of the amine solution into a 500 ml. iodine flask, followed by 25 ml. of the bromate-bromide solution, and dilute with 25 ml. of water. Add 5 ml. of concentrated hydrochloric acid, and stopper the flask immediately. Shake the flask for 1 minute to mix the reactants, and allow to stand for 10 minutes (see Section XIX,1, *b*) with occasional agitation. Cool the flask under the tap or in ice water, and place 10 ml. of 20 per cent. potassium iodide solution in the cup around the stopper. Slightly dislodge the stopper whereupon the iodide solution is drawn into the flask with no loss of bromine. Shake the flask for 30 seconds and allow to stand for 5–10 minutes. Remove the stopper and wash the neck of the flask and the stopper with a little water. Titrate the free iodine with standard 0.1*N* sodium thiosulphate, using 2 ml. of the starch indicator near the end point.

Carry out a blank analysis using 25 ml. of the bromate-bromide solution and 25 ml. of water.

Calculate the percentage purity of the amine by the two methods described in Section XVIII,3.

### XIX,4. DETERMINATION OF AMINES BY TITRATION AS BASES IN NON-AQUEOUS SOLVENTS

#### REAGENTS

*Perchloric acid in glacial acetic acid*, ca. 0.1*N*. Mix 8.5 ml. of 72 per cent. perchloric acid (A.R.) with 500 ml. of glacial acetic acid contained in a litre volumetric flask, add 20 ml. of pure acetic anhydride (*e.g.*, A.R.), and swirl the contents of the flask to ensure thorough mixing. Dilute to 1 litre with glacial acetic acid, and allow to stand overnight to ensure complete reaction of the acetic anhydride with the water present.

Standardise the acetous perchloric acid with A.R. potassium hydrogen phthalate. Weigh out accurately about 0.5 g. of the solid and add it to about 50 ml. of glacial acetic acid; warm until dissolved and cool to room temperature. Add a few drops of methyl violet indicator and titrate the solution with the perchloric acid: the colour change is from violet to blue. Crystal violet may also be used as indicator. A very sharp end point is

obtained by potentiometric titration using a glass and either a calomel or a silver/silver chloride electrode.

The acetous perchloric acid may also be standardised with 0.1N sodium acetate solution. Dissolve an accurately weighed amount (0.53 g.) of dried A.R. anhydrous sodium carbonate in glacial acetic acid and dilute to 100 ml. with this solvent in a volumetric flask. Titrate 25 ml. of the resultant 0.1N sodium acetate with the acid, using methyl violet, crystal violet or  $\alpha$ -naphtholbenzein as indicator.

The acetic acid solution of perchloric acid has a coefficient of expansion of 0.11 per cent. per degree Centigrade. The solution should be used at the temperature of standardisation or a temperature correction applied to the normality. Alternatively, the volume of the titrant is multiplied by  $1 \pm (t \times 0.0011)$  according as to whether the titration is conducted  $t^\circ$  below or above the temperature at which it was standardised.

*Methyl violet indicator.* Dissolve 30 mg. of methyl violet in 100 ml. of chlorobenzene.

*Crystal violet indicator.* Dissolve 1.0 g. of crystal violet in 100 ml. of glacial acetic acid.

*$\alpha$ -Naphtholbenzein indicator.* Dissolve 0.5 g. of  $\alpha$ -naphtholbenzein in 100 ml. of glacial acetic acid.

### PROCEDURE

Dissolve about 0.3 g., accurately weighed, of the amine (*e.g.*, aniline, *p*-toluidine, diethylaniline or quinoline) in 50 ml. of glacial acetic acid in a 250 ml. beaker or conical flask. Add 3 drops of indicator (crystal violet—colour change from blue to blue-green; methyl violet—colour change from violet to green;  $\alpha$ -naphtholbenzein—colour change from golden yellow to green). Run in the acetous perchloric acid from a burette, with stirring, until the colour change occurs.

It is recommended that the end point be determined also by potentiometric titration (glass - calomel or glass - silver/silver chloride electrode system and commercial pH meter) in the presence of the indicator: the correct colour change of the indicator at the end point is thus established.

A blank titration may be made with 50 ml. of glacial acetic acid in the presence of the indicator and a correction applied, if necessary.

### CALCULATION

Calculate the percentage purity of the amine from the expression:

$$\% \text{ Purity} = \frac{V_1 \times N_1 \times M \times 100}{W \times 1000}$$

where  $V_1$  = volume (ml.) of acetous perchloric acid used;

$N_1$  = normality of acetous perchloric acid;

$M$  = molecular weight of amine; and

$W$  = weight (g.) of sample.

**XIX.5. DETERMINATION OF THE  
EQUIVALENT WEIGHT OF AN AMINE (BASE)  
BY ANALYSIS OF ITS CHLOROPLATINATE**

**PROCEDURE**

Dissolve about 1 milli-equivalent, accurately weighed, of the base (say, about 0.1 g. of *p*-toluidine) in 2 ml. of warm dilute hydrochloric acid contained in a 10 ml. beaker. Pour the solution, with stirring, into a slight excess of chloroplatinic acid solution (2–3 ml. of a solution containing 0.5 g. of chloroplatinic acid,  $\text{H}_2\text{PtCl}_6 \cdot 6\text{H}_2\text{O}$ , will suffice). The chloroplatinate of the amine will crystallise out. Cool in ice water for 15 minutes and then filter through a small Hirsch funnel; drain the salt well, wash it with two 1 ml. portions of cold water, and drain again. Transfer the solid to a small crucible, cover with a watch glass, and dry in a steam oven or, better, in a vacuum desiccator overnight. Meanwhile, wash out the beaker, Hirsch funnel and filter paper with hot water until all the residual chloroplatinate has dissolved, add the combined washings to the residual filtrate, and place in the PLATINUM RESIDUES bottle.

Weigh out accurately 0.10–0.15 g. of the dry chloroplatinate into a previously ignited and weighed small porcelain or silica crucible (or a silica Main Smith crucible) and lid. Set the crucible and lid in an inclined position on a pipeclay or silica triangle. Gently heat the upper portion of the crucible with a small flame from a semimicro burner: after 5–10 minutes, increase the size of the flame somewhat in order to heat the whole of the upper portion of the crucible and the lid. The chloroplatinate now becomes heated by conduction and largely decomposes at this stage. Now slowly bring the flame down to the base of the crucible and then, after several minutes, heat more strongly until eventually the whole crucible becomes red hot. (It may be necessary to use a Bunsen flame at this stage.) Allow to cool somewhat, place the crucible in a desiccator until cold, and weigh again. Repeat the ignition until the weight of the crucible and contents is constant. One reheating should suffice.

**CALCULATION**

Calculate the equivalent weight  $E$  of the chloroplatinate  $\text{B}_n\text{H}_2 \cdot \text{PtCl}_6$  from the formula:

$$E = \frac{W \times 195.2}{w}$$

where  $W$  = weight (g.) of the chloroplatinate used;

$w$  = weight (g.) of platinum obtained; and

195.2 = atomic weight of platinum.

If the acidity of the base is known, the molecular weight can be computed: thus for a monoacid base,  $n = 2$ , and for a diacid base  $n = 1$ .

### XIX,6. DETERMINATION OF THE EQUIVALENT WEIGHT OF AN AMINE BY TITRATION OF ITS PICRATE IN NON-AQUEOUS SOLUTION

The picrates of amines behave as bases when they are dissolved in glacial acetic acid and titrated with acetous perchloric acid. When the salt  $(\text{BH})^+\{(\text{NO}_2)_3\text{C}_6\text{H}_2\text{O}\}^-$  or  $(\text{BH})^+(\text{Pic})^-$  is dissolved in glacial acetic acid, the picrate ion is sufficiently basic to give a moderately satisfactory end point by potentiometric titration; the visual end point is sometimes difficult to detect with accuracy.

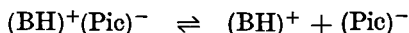

#### PROCEDURE

Prepare the picrate of the base (*e.g.*, pyridine, piperidine, diethanolamine, dimethylaniline or diethylaniline), recrystallise from alcohol, and dry it. Weigh out accurately about 0.8 g. of the picrate, and dissolve it in 50 ml. of glacial acetic acid. Add 2 drops of crystal violet indicator, and titrate with acetous perchloric acid to a blue-green colour; a better end point (disappearance of the purple tinge of the solution) may be obtained with methyl violet indicator (6 drops of 0.2 per cent solution in chlorobenzene). Alternatively, and preferably, determine the end point by potentiometric titration.

Calculate the equivalent weight of the amine picrate (and hence of the amine) from the formula :

$$\text{Equivalent weight} = \frac{\text{Weight of picrate (g.)} \times 1000}{\text{Volume of acetous perchloric acid (ml.)} \times \text{Normality}}$$

*Note on the analysis of some aromatic picrates.* Many picrates of neutral, weakly acidic and weakly basic aromatic compounds may be analysed by titration in aqueous solution. These include the picrates of naphthalene, anthracene, phenanthrene,  $\alpha$ -bromonaphthalene, anisole (prepared in chloroform solution),  $\beta$ -naphthol, *o*-chlorophenol, pyridine, aniline, and *o*-toluidine.

To about 0.25 g., accurately weighed, of the picrate, add 20.0 ml. of standard 0.1N aqueous sodium hydroxide solution, and heat the mixture to boiling. Insert a soda-lime guard tube into the flask and cool to room temperature. Titrate the excess of sodium hydroxide with standard 0.1N hydrochloric acid: use bromothymol blue as indicator.

Calculate the equivalent weight of the picrate.

## CHAPTER XX

### SALTS OF AMINES (INCLUDING QUATERNARY AMMONIUM SALTS)

#### XX.1. DISCUSSION OF SELECTED METHODS FOR THE DETERMINATION OF SALTS OF AMINES

If the amine salts are strongly acidic, like aniline hydrochloride or *p*-toluidine hydrochloride, titration may be carried out directly with standard sodium hydroxide solution in an aqueous medium. This is because considerable hydrolysis occurs in aqueous solution (the compound is a salt formed from a very weak base and a strong acid) and progressive neutralisation of the free acid results ultimately in complete hydrolysis to the amine and strong acid, for example :

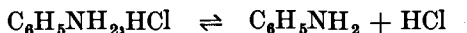

A more general approach is to consider the salts of the type B.HA, where B is the amine. These can be determined in at least two different ways, *viz.*, titration of the base  $\text{A}^-$  with an acid, and titration of the acid  $\text{B.H}^+$  with a base. The method selected will depend on the strength of the base B and of the acid HA.

The titration of the acid  $\text{B.H}^+$  in the salt B.HA with a base may be conducted in an aqueous medium in some cases (*e.g.*, *p*-toluidine hydrochloride) but, in general, it is more satisfactory to employ a basic, non-aqueous medium (such as dimethylformamide or ethylenediamine) to enhance the acidity of the acid. The method is satisfactory provided that the base B is not too strong and the acid HA is not too weak. Azo violet (0.2 per cent. in benzene) may be used as indicator for dimethylformamide and for ethylenediamine: thymol blue (0.3 per cent. in methanol) is also satisfactory for the former. The titrant is 0.1*N* sodium or potassium methoxide in benzene-methanol (compare Section XVIII,3).

The titration of the base  $\text{A}^-$  (in the salt B.HA) may be carried out with perchloric acid in acetic acid provided the acid HA is a weak acid in this medium, *e.g.*, tartaric, oxalic, sulphuric (end point at bisulphate), phosphoric, nitric or picric acid (compare Section XIX,6):

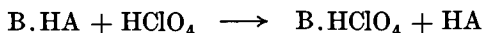

Poor results are obtained with halide acids but the difficulty can

be eliminated by boiling out the halide acid. A far better procedure for salts of amines with halide acids is to add mercuric acetate (which is undissociated in anhydrous acetic acid) when the undissociated mercuric halide is formed and the acetate ion (base) liberated can be titrated without interference using acetous perchloric acid :

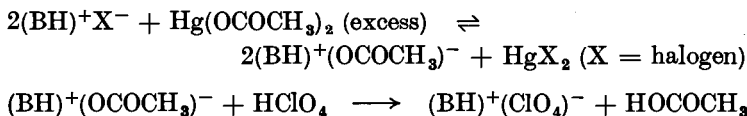

The modest excess of mercuric acetate does no harm, since it is neutral in acetic acid ; water must, of course, be absent in the acetous perchloric acid. The end point may be determined visually (with methyl violet) or potentiometrically.

Quaternary ammonium halides, which are essentially neutral and therefore cannot be titrated directly, may be treated with mercuric acetate in an acetic acid medium, and the resulting acetate titrated with acetous perchloric acid.

## XX.2. DETERMINATION OF AMINE SALTS BY TITRATION IN AQUEOUS SOLUTION

### PROCEDURE

Weigh out accurately 1-2 milli-equivalents of the amine salt (*e.g.*, 0.25 g. of *p*-toluidine hydrochloride) and dissolve the compound in about 25 ml. of distilled water in a 250 ml. conical flask. Add 2 drops of phenolphthalein indicator solution, and titrate with standard 0.1*N* barium hydroxide (or sodium hydroxide) solution (see Chapter XXII) until the solution just acquires a pink colour.

### CALCULATION

Calculate the purity of the amine salt from the formula :

$$\% \text{ Purity} = \frac{V_1 \times N_1 \times M \times 100}{W \times 1000}$$

where  $V_1$  = volume (ml.) of baryta solution used ;  
 $N_1$  = normality of baryta solution ;  
 $M$  = molecular weight of amine salt ; and  
 $W$  = weight (g.) used in the titration.

If the acidity  $a$  of the base is known, the molecular weight of the salt will be the weight which is neutralised by  $a \times 1000$  ml. of  $N$  barium hydroxide solution.

### XX,3. DETERMINATION OF THE HALIDE SALT OF AN AMINE BY TITRATION IN ACETIC ACID WITH ACETOUS PERCHLORIC ACID

#### REAGENTS

*Perchloric acid in acetic acid, 0.1N.* See Section XIX,4.

*Mercuric acetate solution.* Dissolve 6 g. of pure mercuric acetate in 100 ml. of hot glacial acetic acid, and cool the solution to room temperature.

*Crystal violet indicator.* Dissolve 1.0 g. of crystal violet in 100 ml. of glacial acetic acid.

#### PROCEDURE

Weigh out accurately about 1 milli-equivalent of the hydrochloride of the amine (*e.g.*, about 0.15 g. of monomethylaniline hydrochloride) into a 250 ml. conical flask, dissolve it in 50 ml. of warm glacial acetic acid, and cool to room temperature. Add 10 ml. of the mercuric acetate solution and 2 drops of crystal violet indicator. Titrate with standard 0.1N acetous perchloric acid to a blue-green colour. It is strongly recommended that the end point be determined potentiometrically with a glass and calomel electrode system: this will provide a valuable check on the visual end point.

Calculate the purity of the sample of amine hydrochloride using a formula similar to that given in Section XX,2.

### XX,4. DETERMINATION OF QUATERNARY AMMONIUM HALIDES BY TITRATION IN ACETIC ACID WITH ACETOUS PERCHLORIC ACID

#### PROCEDURE

Prepare the reagents as in Section XX,3.

Weigh out accurately about 3 milli-equivalents of the dry, finely powdered sample (*e.g.*, tetramethylammonium iodide, cetyl trimethylammonium bromide or cetyl pyridinium bromide) into a 250 ml. conical flask. Dissolve the sample in 50–100 ml. of glacial acetic acid, warming if necessary. Add 10 ml. of the mercuric acetate reagent and swirl to mix the contents of the flask. Titrate with standard 0.1N perchloric acid in acetic acid. The preferred method for the detection of the end point is potentiometric titration using the glass and calomel electrodes and the millivolt scale of a commercial pH meter; the end point is easily deduced from the differential titration curve (compare Fig. XV, 4, 5). The end point may also be determined, but less accurately, with crystal violet as indicator: it is best to establish

the correct colour shade at the equivalence point from the potentiometric titration and to use a comparison solution.

### CALCULATION

Calculate the percentage purity of the quaternary ammonium salt from the formula :

$$\% \text{ Purity} = \frac{V_1 \times N_1 \times M \times 100}{W \times 1000}$$

where  $V_1$  = volume (ml.) of the perchloric acid solution ;  
 $N_1$  = normality of perchloric acid ;  
 $M$  = molecular weight of quaternary ammonium salt ; and  
 $W$  = weight (g.) of sample.



CHAPTER XXI  
AMINO ACIDS

**XXI,1. DISCUSSION OF SELECTED  
METHODS FOR THE DETERMINATION OF  
AMINO ACIDS**

The following general methods may be used :—

(a) *Titration in glacial acetic acid.* An excellent procedure consists in the titration of amino acids as bases. This is achieved by the use of glacial acetic acid as solvent, which enhances the basic properties of the amino group; titration with acetous perchloric acid then becomes possible :

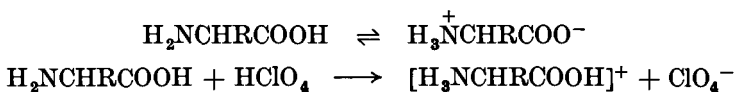

Solution of the amino acid is facilitated by dissolving it in excess of acetous perchloric acid and titrating the excess of acid with a standard base, such as a solution of sodium acetate in acetic acid :

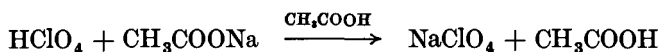

The end point may be determined visually (methyl violet or crystal violet indicator) or potentiometrically (glass and calomel electrode system and commercial pH meter).

(b) *Formol titration.* Amino acids are present in aqueous solution largely as zwitter ions and cannot be titrated directly with standard alkali owing to the buffering effect of the zwitter ions. If the aqueous solution of the amino acid is treated with an excess of a carefully neutralised solution of formaldehyde, it can then be titrated with a solution of a strong alkali. The reaction probably involves the primary neutralisation :

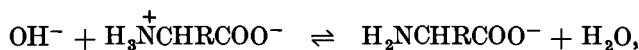

followed by, or accompanied by, condensation of the anion with formaldehyde to give a stable anion, probably thus :

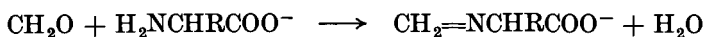

It will be noted that the carboxyl group is not involved.

(c) *Van Slyke method.* This method is based upon the measurement of the volume of nitrogen liberated upon treatment of an amino acid (or a primary amine) with nitrous acid :

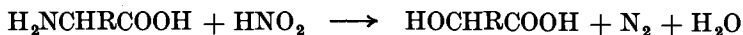

During the determination the unstable nitrous acid solution decomposes spontaneously :



The solution of the amino acid is introduced into the nitrous acid (from a solution of sodium nitrite acidified with acetic acid), the gas evolved—a mixture of nitrogen and nitric oxide—is passed into a Hempel-type pipette charged with alkaline potassium permanganate solution whereupon the nitric oxide is absorbed ; the residual nitrogen is measured in a special gas burette. The procedure requires a special apparatus, which can be purchased, but is time consuming and not particularly accurate. It will not be discussed further.

(d) *Titration in pyridine or in ethylenediamine.* The basis of this procedure is the titration of amino acids as acids. The amino acid is dissolved in the minimum volume of water and the solution diluted with pure pyridine. Titration with a solution of tetra-*n*-butylammonium hydroxide in benzene - methanol (Section XVIII,1) is then possible. The end point may be determined either potentiometrically with the glass - calomel electrode system or visibly with the aid of thymol blue indicator. Satisfactory results have been obtained with glycine, alanine, leucine, aspartic acid, glutamic acid, etc.

Titration may also be carried out in anhydrous ethylenediamine as solvent and with sodium aminoethoxide in monoethanolamine - ethylenediamine as titrant. Atmospheric moisture and carbon dioxide must be excluded so that some type of closed system must be used. The end point is determined potentiometrically : an antimony - calomel electrode system is applicable, but better results are obtained with an ingenious antimony - antimony electrode system. The indicator electrode is a cast antimony rod dipping into the solution being titrated, and the reference electrode is an antimony rod mounted in the burette below the stopcock. The elongated burette tip is immersed in the solution of the amino acid, thus making contact between the two electrodes. This device affords the advantage of a continuous flushing of the reference electrode to prevent diffusion : renewing of the liquid junction occurs at the end of the burette tip, serving as a salt bridge, with addition of each new increment of titrant. Good results are given by glycine,  $\epsilon$ -aminocaproic acid, anthranilic acid and *p*-aminobenzoic acid.

The over-all reaction involved in the titration of a carboxylic acid in ethylenediamine with sodium aminoethoxide may be represented by the following equations :

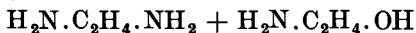
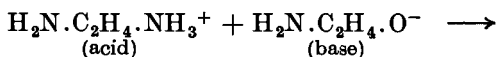
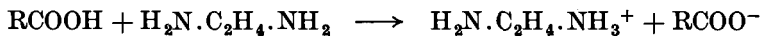

The neutralisation reaction thus merely involves transfer of a proton from the cation to the anion with regeneration of the two bases.

The solution of *sodium aminoethoxide in ethylenediamine-ethanolamine* is prepared as follows. Dissolve about 2.5 g. of clean sodium, which has been washed successively in ethanol and ethanolamine, in 100 ml. of anhydrous ethanolamine (with cooling, if necessary), and dilute to 500 ml. with anhydrous ethylenediamine. Standardise the resulting solution with A.R. benzoic acid dissolved in ethylenediamine : determine the end point potentiometrically.

## XXI.2. DETERMINATION OF AMINO ACIDS BY TITRATION AS BASES IN GLACIAL ACETIC ACID

### REAGENTS

Prepare the reagents as described under Amines in Section XIX,4, together with :

*Sodium acetate, 0.1N.* Add 5.300 g. of A.R. anhydrous sodium acetate in small portions to 200 ml. of glacial acetic acid contained in a litre volumetric flask. Shake well after each addition to ensure that each portion of sodium carbonate has reacted completely before adding a further quantity. When all the sodium carbonate has been added, dilute with glacial acetic acid to the mark.

Standardise the solution, if desired, by running it from a burette into 25 ml. of 0.1N acetous perchloric acid, using 2 drops of crystal violet solution as indicator.

### PROCEDURE

Weigh out accurately about 3 milli-equivalents of the amino acid (*e.g.*, about 0.20 g. of glycine or alanine) into a 250 ml. conical flask, add 50.0 ml. of 0.1N acetous perchloric acid, and gently swirl the solution until the amino acid dissolves. Add 2-3 drops of crystal violet or methyl violet indicator. Back titrate the excess of perchloric acid with 0.1N sodium acetate in acetic acid to the first appearance of a violet tinge (1).

Perform a blank experiment by titrating 50.0 ml. of the 0.1*N* perchloric acid with the sodium acetate solution.

**Note.**

(1) With some amino acids, *e.g.* anthranilic acid, the end point with methyl violet indicator is the first appearance of a bottle green colour.

**CALCULATION**

Calculate the purity of the amino acid from the formula :

$$\% \text{ Purity} = \frac{(V_1 - V_2) \times N_1 \times M \times 100}{W \times 1000}$$

where  $V_1$  = volume (ml.) of sodium acetate solution used for blank ;  
 $V_2$  = volume (ml.) of sodium acetate solution used for sample  
 $N_1$  = normality of sodium acetate solution ;  
 $M$  = molecular weight of amino acid ; and  
 $W$  = weight (g.) of sample.

**XXI,3. DETERMINATION OF AMINO ACIDS BY FORMOL TITRATION**

**PROCEDURE**

Weigh out accurately about 30 milli-equivalents of the amino acid (*e.g.*, about 2.0 g. of glycine) into a 250 ml. volumetric flask, dissolve it in boiled-out distilled water, and make up to the mark with boiled-out distilled water. Mix well.

Place 50.0 ml. of commercial "formalin" solution (35–40 per cent. formaldehyde) in a conical flask, add 1 ml. of thymolphthalein indicator solution (0.04 per cent. in 70 per cent. ethanol), and titrate with 0.1*N* sodium hydroxide until the solution has a greenish colour (1).

Transfer 25 ml. of the solution of the amino acid to a 250 ml. conical flask, add 10 ml. of the "neutral" formaldehyde solution, and titrate with standard 0.1*N* barium hydroxide solution to the first appearance of a blue colour. Repeat with two further 25 ml. portions in order to obtain consistent titrations.

To check that the amino acid is free from strongly acidic impurities, titrate 25 ml. of the solution of the amino acid with the standard 0.1*N* barium hydroxide solution to a *pH* of about 8.0 (green colour with B.D.H. Universal Indicator) (2). The volume of the blank (which is usually negligible for glycine and alanine) must be deducted from the volume of baryta solution used in the actual "formol" titration.

**Notes.**

(1) Potentiometric titration confirms that thymolphthalein is a better indicator than phenolphthalein; the latter leads to slightly low results. "Formalin" solution (35–40 per cent.) appears to have some effect upon

the colour of the indicator : thymolphthalein assumes a green colour in basic solution in the presence of the strong " formalin ".

(2) The use of phenolphthalein or thymolphthalein in determining the blank for the solution of the free amino acid is not altogether satisfactory. Potentiometric titration shows that a *pH* of about 8·0 (revealed by the green colour with B.D.H. Universal indicator) is acceptable.

### CALCULATION

Calculate the purity of the amino acid from the formula :

$$\% \text{ Purity} = \frac{V_1 \times N_1 \times M \times 100}{W \times 1000}$$

where  $V_1$  = volume of baryta solution (ml.) less blank for acid impurities ;

$N_1$  = normality of baryta solution ;

$M$  = molecular weight of amino acid ; and

$W$  = weight (g.) of amino acid used in the titration.

## CHAPTER XXII

### CARBOXYL GROUPS

#### XXII.1. DISCUSSION OF SELECTED METHODS FOR THE DETERMINATION OF CARBOXYL GROUPS

The following methods are available for the analysis of carboxylic acids :—

(a) *Direct titration in aqueous, aqueous-alcoholic or alcoholic solution.* The most direct method for the determination of water-soluble carboxylic acids is titration with standard alkali (barium, potassium or sodium hydroxide) using phenolphthalein as indicator. The preferred base is barium hydroxide solution since it can easily be prepared free from carbonate. Standard sodium hydroxide solution may also be employed and is prepared from the solid of analytical reagent purity ; it should be used if the acid forms an insoluble barium salt. To obtain a sharp end point with phenolphthalein indicator, the solution should be free from carbon dioxide ; if necessary, the latter may be removed either by boiling the solution or by passing nitrogen from a cylinder through the warm solution both before and during the titration.

The  $pH$  at the stoichiometric end point or the equivalence point of the neutralisation reaction will naturally depend upon the ionisation constant of the carboxylic acid. Neutralisation produces the salt of the weak acid and a strong base, consequently the resulting solution will be slightly alkaline, having a  $pH$  greater than 7. Most carboxylic acids are neutralised at a  $pH$  of about 8.4, rendering phenolphthalein a satisfactory indicator ( $pH$  interval 8.3–10.1 ; colourless to red). In general, the choice of an indicator for a titration is dictated by the acid to be determined, *i.e.*, the colour change interval of the indicator must include the equivalence point. The absolute method for determining the proper indicator for a given system is by reference to potentiometric titration, *e.g.*, with the glass and saturated calomel electrode pair and a commercial  $pH$  meter ; if an indicator is present during the titration, the colour change can be established unequivocally in relation to the equivalence point. Other indicators which sometimes find application in the acidimetric titration of organic acids are thymol blue ( $pH$  interval 8.0–9.6 ; yellow to blue) and thymolphthalein ( $pH$  interval 9.4–10.6 ; colourless to blue). Mixed indicators (*e.g.*, 2 parts of 0.1 per cent. alcoholic methyl red and 5 parts of 0.1 per cent. bromocresol green) are used to secure a sharp end point when the equivalence point is in a region where a

single indicator exhibits a broad range or where the colour of the single indicator may be obscured.

The reactions involved may be represented by the following equations :

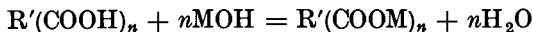
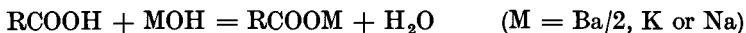

The *neutralisation equivalent*, the number of grams of acid required to neutralise one litre of normal alkali, may readily be calculated ; if the basicity of the acid is known, the molecular weight may be computed.

Acids that are insoluble in water may be dissolved in neutral aqueous or absolute methanol or ethanol, and titrated with standard alkali using phenolphthalein as indicator. Some water-insoluble acids may be dissolved in excess of aqueous alkali ; the excess of alkali is titrated with standard hydrochloric acid. When titrations are made with methanol or ethanol as solvent, it is recommended that a blank titration be carried out using the same amount of solvent and of indicator : the difference between the two titrations gives the volume of alkali consumed by the organic acid.

For a few classes of compounds where difficulties are experienced in aqueous systems, *e.g.*, titrations of formic acid in methyl formate (which is easily hydrolysed) or of free acids in the presence of aldehydes (say, benzoic acid in benzaldehyde), dry methanol may be used as solvent. The titrant is a standard solution of sodium methoxide in methanol.

The non-aqueous systems to be described under (b) below are to be interpreted as excluding the use of pure methanol and pure ethanol as solvents.

(b) *Direct titration in non-aqueous solvents.* For acids which are insoluble in water or give poorly defined end points in aqueous or alcoholic solutions, a non-aqueous system may be used. The procedures to be described are particularly valuable for weak acids and for weak polybasic acids. The acid is dissolved in benzene - methanol (4 : 1, v/v), acetonitrile, dimethylformamide or pyridine, and then titrated with a solution of potassium methoxide or of sodium methoxide in benzene - methanol (compare Section XVIII,4). Thymol blue (colour change : yellow to blue) may serve as indicator for weak monobasic acids ; for very weak monobasic acids and for dibasic acids, azo violet indicator (colour change : red to violet or blue) is satisfactory. Ethylenediamine is also a useful solvent for very weak acids and may be employed in conjunction with *o*-nitroaniline indicator (colour change : yellow to orange red).

A solution of tetra-*n*-butylammonium hydroxide or of triethyl-*n*-butylammonium hydroxide in benzene-methanol (compare Section XVIII,1) is an extremely useful titrant for monobasic and dibasic organic acids (see Section XV,5). Titration may be carried out in acetonitrile, dimethylformamide or pyridine as solvent: the end point may be determined visually (thymol blue or azo violet indicator) or potentiometrically with the aid of the glass-calomel electrode system.

(c) *By iodometric titration.* The acid content of a solution of a strong acid may be determined by the addition of excess of a neutral solution of potassium iodate and potassium iodide, whereupon the hydrogen ions yield an equivalent amount of iodine:

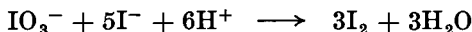

The liberated iodine is titrated with a standard solution of sodium thiosulphate. This method is particularly advantageous in the titration of very dilute solutions of strong acids, because a very sharp colour change is obtained at the end point.

With weak organic acids (dissociation constants  $> 10^{-6}$ ), the iodometric titration is not so simple, since the removal of the hydrogen ions by reaction with iodate and iodide leads to a buffer system of the weak acid and its salt:



At the resulting low hydrogen ion concentration, the rate of reaction between hydrogen ions, iodate and iodide may become very small. This experimental difficulty can be surmounted by adding an excess of standard sodium thiosulphate solution after the introduction of the iodate-iodide solution; the iodine formed in the reaction is thus removed and the reaction velocity is increased considerably. Ultimately, the excess of thiosulphate remaining after completion of the reaction is back titrated with standard iodine solution.

(d) *By analysis of the silver salt.* The silver salts of most carboxylic acids are sparingly soluble in cold water, and are easily prepared by treating a solution of the ammonium salt with a slight excess of silver nitrate solution. They usually crystallise without water of crystallisation, but many are sensitive to light: drying should therefore be conducted with minimum exposure to light. The analysis is made by gentle ignition of the dry silver salt in a crucible, the organic matter is driven off and pure metallic silver remains. Some silver salts (*e.g.*, silver oxalate) decompose violently upon heating: the effect of heat upon a small quantity of the silver salt should be investigated qualitatively before the quantitative determination. The method cannot be applied



directly to acids which contain halogen or sulphur ; ignition of the silver salts of the former would give silver halide, those of the latter would yield silver sulphide containing silver sulphate.

## XXII,2. DETERMINATION OF THE EQUIVALENT WEIGHT OF A CARBOXYLIC ACID BY TITRATION WITH STANDARD ALKALI SOLUTION IN AQUEOUS, AQUEOUS - ALCOHOLIC OR ALCOHOLIC SOLUTION

### REAGENTS AND APPARATUS

*Barium hydroxide solution, 0.05N.* Shake 17 g. of powdered A.R. barium hydroxide,  $\text{Ba}(\text{OH})_2 \cdot 8\text{H}_2\text{O}$ , with about 2 litres of distilled water, allow the solution to settle, and siphon the clear solution into the

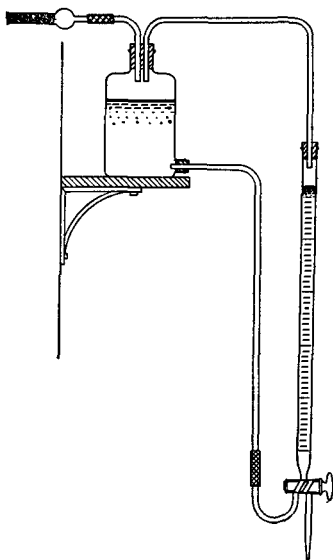

Fig. XXII, 2, 1.

storage vessel ; the latter is previously filled with nitrogen or with air free from carbon dioxide. The storage vessel consists of a 2.5 litre aspirator and is placed on a shelf ; it is equipped with a 50 ml. Grade A burette as shown in Fig. XXII, 2, 1. Alternatively, a storage bottle (this is usually of 1 litre capacity) and burette with an automatic filling device may be used (Fig. XXII, 2, 2). The solution is pumped into the burette and enters it through a glass tube which terminates in a capillary exactly at the zero mark ; immediately the pressure is

released, the solution above the zero mark is automatically siphoned back into the storage bottle. The burette supplied with the apparatus may be of 10 ml. capacity and is usually calibrated in 0.02 ml. : it can therefore be used for semimicro work. Fig. XXII, 2, 3 illustrates a semimicro burette with reservoir ; it has a capacity of 5 or 10 ml. and is calibrated in 0.02 ml.

Standardise the baryta solution with A.R. benzoic acid or with A.R. potassium hydrogen phthalate, using phenolphthalein as indicator.

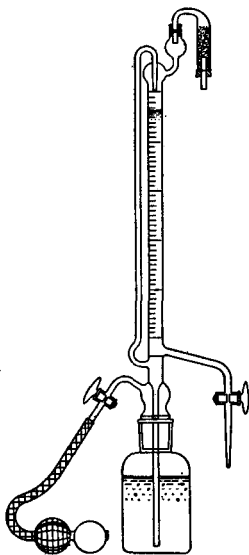

Fig. XXII, 2, 2.

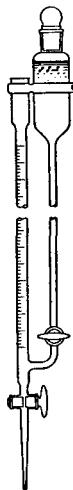

Fig. XXII, 2, 3.

Shake the reservoirs of the apparatus shown in Figs. XXII, 2, 2-3 before standardisation to ensure thorough mixing.

*Phenolphthalein indicator.* Dissolve 1.0 g. of phenolphthalein in 100 ml. of ethanol and then dilute with 100 ml. of water.

### PROCEDURE

Dissolve about 10 milli-equivalents, accurately weighed, of the acid (*e.g.*, 0.12 g. of phenylacetic acid or 0.06 g. of succinic acid) in 25 ml. of boiled-out distilled water in a 100 or 250 ml. conical flask, and titrate with the barium hydroxide solution, using phenolphthalein (1-2 drops) as indicator. Repeat the determination.

This procedure can be adapted to the semimicro scale by the use of 0.02*N* barium hydroxide solution. Dissolve the sample (20 to 30 mg.) in 10 ml. of water in a 50 ml. conical flask, add 1 drop of phenolphthalein indicator, and titrate to a definite pink colour with the 0.02*N* barium hydroxide solution.

## CALCULATION

Calculate the equivalent weight  $E$  of the acid from the expression :

$$E = \frac{\text{Weight of sample (g.)} \times 1000}{\text{Ml. of Ba(OH)}_2 \text{ solution} \times \text{Normality}}$$

**XXII,3. DETERMINATION OF THE EQUIVALENT WEIGHT OF A CARBOXYLIC ACID BY TITRATION WITH STANDARD SODIUM METHOXIDE SOLUTION IN A NON-AQUEOUS MEDIUM**

## REAGENTS

*Benzene-methanol.* Mix 4 volumes of A.R. benzene with 1 volume of anhydrous methyl alcohol.

*Sodium methoxide solution, 0.1N.* See Section XVIII,3. Standardise with A.R. benzoic acid.

*Thymol blue indicator.* Dissolve 0.3 g. of thymol blue in 100 ml. of methanol.

*Azo violet indicator.* See Section XVIII,3.

## PROCEDURE

Dissolve 0.4–0.8 milli-equivalents, accurately weighed, of the acid in 20 ml. of either benzene - methanol or purified dimethylformamide. Add 2 drops of thymol blue indicator or (for very weak acids) of azo violet indicator. Titrate the solution with the standard 0.1N sodium methoxide solution to the colour change of the indicator.

If dimethylformamide is used as the solvent, it is better to follow the experimental details given under Phenols in Section XVIII,4—magnetic stirrer, minimum exposure to the atmosphere, etc. The end point may also be determined potentiometrically with the glass and calomel electrode system: the antimony - calomel electrode system also gives satisfactory results.

Calculate the equivalent weight, or neutralisation equivalent, of the acid.

**XXII,4. DETERMINATION OF THE EQUIVALENT WEIGHT OF A CARBOXYLIC ACID BY IODOMETRIC TITRATION**

## REAGENTS

*Potassium iodate-potassium iodide reagent.* Dissolve 3.0 g. of A.R. potassium iodate and 25 g. of A.R. potassium iodide in 200 ml. of water.

*Sodium thiosulphate solution, 0.1N.* See Section XVIII,3.

*Starch indicator solution.* See Section XVII,2.

*Iodine solution, 0.1N.* Dissolve 20 g. of iodate-free potassium iodide (e.g., A.R.) in 30–40 ml. of water in a glass-stoppered 1-litre

volumetric flask. Weigh out about 12·7 g. of A.R. iodine on a watch glass on a rough balance, and transfer it by means of a small dry funnel into the concentrated potassium iodide solution. Insert the glass stopper into the flask, and shake in the cold until all the iodine has dissolved. Dilute to 1 litre with distilled water. The resulting solution is best stored in a dark, glass-stoppered bottle. It may be standardised with A.R. arsenious oxide or with standard 0·1*N* sodium thiosulphate solution.

### PROCEDURE

Weigh out accurately about 2 milli-equivalents of the organic acid (*e.g.*, 0·25–0·30 g. of phenylacetic acid or of tartaric acid) into a 350 ml. iodine flask, dissolve it in water, and add 20 ml. of the potassium iodate-potassium iodide reagent, followed by 40·0 ml. of standard 0·1*N* sodium thiosulphate solution (1). Allow the mixture to stand for 15–30 minutes, and titrate the excess of thiosulphate with standard 0·1*N* iodine in the presence of starch as indicator.

#### Note.

(1) Satisfactory results are obtained with some acids by merely adding the iodate-iodide mixture to the solution of the acid. It is essential to have a homogeneous solution and to keep the solution well stirred, preferably by means of a magnetic stirrer; with sparingly soluble acids, such as benzoic acid, 50 per cent. ethanol by volume may be used to effect solution. The liberated iodine is titrated with standard sodium thiosulphate solution after 30–60 minutes.

### CALCULATION

Calculate the purity of the carboxylic acid from the formula :

$$\% \text{ Purity} = \frac{V \times N_1 \times M \times 100}{W \times n \times 1000}$$

where  $V$  = net volume (ml.) of thiosulphate solution consumed by sample ;

$N_1$  = normality of sodium thiosulphate solution ;

$M$  = molecular weight of the acid ;

$W$  = weight (g.) of sample ; and

$n$  = basicity of acid.

The equivalent weight of the acid is the weight of the acid which reacts with 1000 ml. of  $N$  sodium thiosulphate solution.

## XXII,5. DETERMINATION OF THE EQUIVALENT WEIGHT OF AN ACID BY ANALYSIS OF ITS SILVER SALT

### PROCEDURE

Dissolve or suspend 0·5 g. of the acid (*e.g.*, benzoic acid or phenylacetic acid) in 20–25 ml. of distilled water in a 250 ml. conical flask or beaker, and add dilute ammonia solution until

the acid has dissolved and the well-stirred solution smells of ammonia. Boil the solution gently until the excess of ammonia has been removed—test the steam with red litmus paper. Cool and add 5 per cent. silver nitrate solution with stirring until no further precipitation occurs. Filter off the precipitate through a small Buchner funnel with suction, drain well, wash the precipitate at least three times with small volumes of cold water to remove excess of silver nitrate, and finally drain thoroughly by pressing the solid with a glass stopper. Transfer the precipitate to a small evaporating basin and cover with a clock glass; dry *either* in a steam oven (30–60 minutes) and allow to cool in a desiccator *or* leave in a desiccator, covered with brown paper to exclude light, overnight.

Meanwhile, heat a clean porcelain or silica crucible and lid on a pipe-clay or silica triangle over a Bunsen flame, allow to cool in a desiccator and weigh. Introduce about 0.3 g. of the silver salt and weigh again. Place the crucible and lid in an inclined position (say, at an angle of about 30° from the horizontal) on the pipe-clay or silica triangle, and heat the upper portion of the crucible gently with a very small Bunsen flame or with a semi-micro burner. After 5–10 minutes, increase the size of the flame somewhat in order to extend the heating ultimately to the whole of the upper portion of the crucible and lid. The silver salt at the bottom of the crucible becomes heated by conduction and gradually decomposes. Extend the heating to the base of the crucible and, after about 5 minutes, heat more strongly until eventually the bottom of the crucible is red hot. Allow the crucible to cool somewhat, and place it in a desiccator. When quite cold, weigh again. Repeat the ignition until the weight of the crucible and contents is constant.

### CALCULATION

Calculate the equivalent weight  $E$  of the acid from the formula :

$$E = \frac{107.9(w - x)}{x} + 1$$

where  $w$  = weight (g.) of the silver salt used ;

$x$  = weight (g.) of silver produced ; and

107.9 = equivalent and also atomic weight of silver.

If the basicity of the acid is known, the molecular weight can be obtained.

## CHAPTER XXIII

### SALTS OF CARBOXYLIC ACIDS

#### XXIII,1. DISCUSSION OF SELECTED METHODS OF ANALYSIS

The most direct procedure for the analysis of salts of carboxylic acids is titration in glacial acetic acid as a solvent with a standard solution of perchloric acid in glacial acetic acid. Use is made of the fact that many salts which have little or no basic properties in water behave as comparatively strong bases in acetic acid (compare Section XV,4), consequently titration with acetous perchloric acid becomes possible. The anion of the salt is, of course, the effective base, since it accepts protons in an acetic acid medium from acetous perchloric acid :

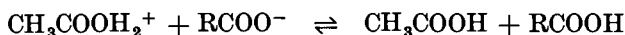
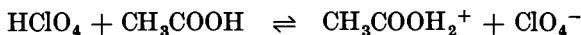

The end point may be determined potentiometrically using glass and calomel electrodes and a commercial pH meter. A visual indicator (*e.g.*, crystal violet) can often be used but it is advisable to establish the correct colour change at the end point by potentiometric titration in the presence of the indicator. Thus crystal violet indicator can pass through violet, blue, blue-green, green, green-yellow and yellow ; for most carboxylic acid salts, titration to the blue-green colour is correct and no indicator correction is necessary.

Another procedure utilising ion exchange resins is described in Chapter XXXVI.

Many alkali metal and alkaline earth salts of organic acids upon ignition in air ultimately yield the carbonate of the metal. The carbonate is analysed by addition of excess of standard hydrochloric or sulphuric acid, followed by titration of the residual acid with standard sodium hydroxide solution. Satisfactory results are obtained *inter alia* with sodium acetate, benzoate, citrate, succinate, *n*-hexoate, palmitate and laurate, with potassium acetate, succinate, acid phthalate and tartrate, with calcium citrate and stearate, and with barium acetate and tartrate.

The metal content of the sodium, potassium, calcium, strontium and barium salts of carboxylic acids may be determined by heating a weighed, dry sample in a crucible with sulphuric acid. The organic matter is destroyed and the sulphate of the metal remains; occasionally a little nitric acid must be added to oxidise the carbon completely. The metal is weighed as the sulphate.

## XXIII,2. DETERMINATION OF SALTS OF CARBOXYLIC ACIDS BY TITRATION IN ACETIC ACID WITH ACETOUS PERCHLORIC ACID

### REAGENTS

*Perchloric acid in acetic acid, 0·1N.* See Section XIX,4. Standardise the acid with A.R. potassium hydrogen phthalate.

*Crystal violet indicator.* Dissolve 1·0 g. of crystal violet in 100 ml. of glacial acetic acid.

### PROCEDURE

Weigh out accurately 2–3 milli-equivalents of the salt (*e.g.*, about 0·21 g. of anhydrous sodium acetate, about 0·39 g. of ammonium benzoate or of sodium benzoate, or about 0·45 g. of sodium salicylate) into a 250 ml. conical flask, add 30 ml. of glacial acetic acid, and swirl the contents of the flask gently until the solid dissolves. Gentle warming may sometimes be necessary, but the mixture must be cooled before titration. Add 1 drop of crystal violet indicator, and titrate with standard 0·1*N* acetous perchloric acid until the colour changes to blue-green. Magnetic stirring is advantageous and is essential for the potentiometric titration.

It is recommended that the titration be performed potentiometrically (glass and calomel electrodes; *pH* meter) and the end point evaluated from the plot of millivolts (ordinates) against ml. of perchloric acid (compare Section XV,4).

### CALCULATION

Calculate the percentage purity of the salt from the formula :

$$\% \text{ Purity} = \frac{V \times N_1 \times E \times 100}{W \times 1000}$$

where *V* = volume (ml.) of perchloric acid solution used ;

*N*<sub>1</sub> = normality of the acetous perchloric acid ;

*E* = equivalent weight of the salt ; and

*W* = weight (g.) of sample.

One mol of carboxyl group requires one equivalent of perchloric acid.

**XXIII,3. DETERMINATION OF ALKALI  
METAL AND ALKALINE EARTH SALTS OF  
CARBOXYLIC ACIDS BY IGNITION**

**PROCEDURE**

Weigh out accurately about 10 milli-equivalents of the sodium or potassium salt into a previously ignited and weighed platinum crucible (1). Place the crucible on a silica triangle resting on a tripod, and heat cautiously at first with a small flame; as decomposition proceeds, increase the size of the flame until eventually the crucible is at a dull red heat. Continue the ignition until all traces of carbon have been burned off, and allow to cool. Transfer the crucible to a 600 ml. beaker containing 50.0 ml. of standard 0.2*N* sulphuric acid: cover the beaker with a clock glass to prevent loss of solution by spraying during the subsequent evolution of carbon dioxide. Boil the solution gently for 20–30 minutes to expel all the dissolved carbon dioxide, cool, dilute and titrate the excess of acid with standard 0.2*N* sodium hydroxide solution, using phenolphthalein as indicator.

For calcium, strontium and barium salts, use 50.0 ml. of standard 0.2*N* hydrochloric acid to dissolve the metallic carbonate. To avoid loss in the subsequent boiling, it is best, as soon as the residue from the ignition has dissolved, to titrate the excess of hydrochloric acid with standard 0.2*N* sodium hydroxide solution, using methyl red as indicator. The solution is now barely acidic. Now boil gently for 20–30 minutes to eliminate carbon dioxide, cool, and titrate to the end point as above.

Titrate 50.0 ml. of the standard acid with the standard alkali.

**CALCULATION**

Calculate the purity of the salt by means of the formula :

$$\% \text{ Purity} = \frac{(V_1 - V_2) \times N_1 \times M \times 100}{W \times A \times 1000}$$

where  $V_1$  = volume (ml.) of standard NaOH required for 50.0 ml. of standard acid ;

$V_2$  = volume of standard NaOH used for sample ;

$N_1$  = normality of NaOH solution ;

$W$  = weight (g.) of sample ; and

$A$  = valency of cation  $\times$  number of metal atoms per mol of salt.

**Note.**

(1) Carbonates attack porcelain, hence a platinum crucible is used.



**XXIII,4. DETERMINATION OF THE  
METAL CONTENT OF ALKALI METAL OR  
ALKALINE EARTH SALTS OF CARBOXYLIC ACIDS  
BY CONVERSION INTO SULPHATES**

**PROCEDURE**

Clean a porcelain or silica crucible and lid\* with dilute nitric acid, wash, dry and heat to redness for 5 minutes. When almost cool, transfer to a desiccator, and weigh after 20 minutes. Weigh out accurately 0.1–0.2 g. of the salt into the crucible and place it on a silica triangle resting on a tripod. Add, by means of a medicine dropper, about 1.0 ml. of dilute sulphuric acid (20 per cent. ; v/v), replace the lid, and warm very gently with a semi-micro burner (Fume cupboard or hood !); remove the flame as soon as any foaming occurs. Gradually increase the size of the flame to drive off the volatile products and then the sulphur trioxide. Finally heat strongly with a Bunsen flame for 1 minute. Remove the flame and allow to cool. Add 2 drops of concentrated sulphuric acid and heat again to drive off sulphur trioxide. If the residue contains particles of carbon, allow the crucible to cool, add 2–3 drops of concentrated nitric acid, evaporate and ignite again for 2 minutes. Cool, add 2 drops of concentrated sulphuric acid, heat until all the sulphur trioxide is expelled, and then ignite at a dull red heat for 5 minutes. Allow to cool almost to room temperature, place in a desiccator, and weigh after 20 minutes.

Calculate the percentage of metal in the salt using the appropriate factor for metal/metal sulphate.

\* A crucible with interior-fitting serrated lid—the Main-Smith crucible—is particularly suitable; see, for example, A. I. Vogel, *Text-Book of Quantitative Inorganic Analysis: Theory and Practice*, Second Edition, 1951, p. 218 (Longmans, Green and Co. Ltd.).

## CHAPTER XXIV

### ANHYDRIDES OF CARBOXYLIC ACIDS

#### XXIV,1. DISCUSSION OF SELECTED METHODS OF ANALYSIS

Anhydrides of carboxylic acids may be, and usually are, contaminated with the free carboxylic acid: it is accordingly necessary to have a procedure which can determine both the anhydride and acid in the presence of one another or, alternatively, is specific for the anhydride in the presence of its acid. One example of each procedure will be described.

(a) *Esterification—hydrolysis method.* One portion of the sample is titrated directly at room temperature with a standard solution of sodium methoxide in methyl alcohol:

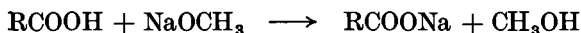
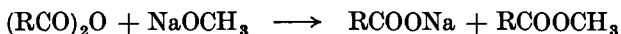

A second portion of the sample is hydrolysed with water in the presence of pyridine as catalyst, and the total acidity is determined by titration with standard aqueous sodium hydroxide solution at room temperature:

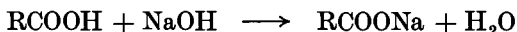
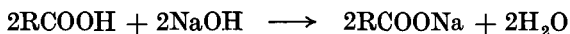

The anhydride and free acid content can be computed from the results of the two titrations (see Section XXIV,2); the titrations will incidentally indicate whether any neutral impurity is present in the anhydride. If it is known that the only impurity is the free acid corresponding to the anhydride, then the percentage of anhydride can be evaluated from the sodium methoxide titration alone. Both titrations are, however, desirable if only to obtain an independent check on the presence of neutral impurities in the sample of anhydride.

(b) *Morpholine method.* Morpholine reacts with anhydrides thus:

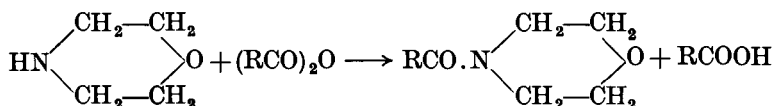

This reaction forms the basis of a direct method for determining anhydrides. A measured excess of a solution of morpholine in methanol is added to the sample. The morpholine reacts mol for mol with the anhydride producing one mol each of the amide and the acid. After reaction is complete (about 5 minutes), the excess of the base is determined by titration with standard methanolic hydrochloric acid, using methyl yellow - methylene blue as the indicator. The method is not applicable to anhydrides where the corresponding acids have primary dissociation constants in water greater than  $2 \times 10^{-2}$  (e.g., maleic and citraconic anhydrides), since the free acids are acidic to the indicator in the methyl alcohol system.

## XXIV.2. DETERMINATION OF ANHYDRIDES BY ESTERIFICATION AND HYDROLYSIS

### REAGENTS

*Sodium methoxide solution*, ca. 0.5N. Place 250 ml. of absolute methanol in a 500 ml. flask equipped with a reflux condenser. Add 3.0 g. of clean sodium, cut into small pieces, at such a rate that only gentle refluxing occurs. Store in a glass-stoppered bottle. Standardise with standard 0.5N sulphuric acid or with A.R. potassium hydrogen phthalate just before use.

*Sodium hydroxide solution*, ca. 0.5N. Dissolve 5.0 g. of A.R. sodium hydroxide pellets in water and dilute to 250 ml. with distilled water in a volumetric flask. Standardise with standard 0.5N sulphuric acid or with A.R. potassium hydrogen phthalate.

*Phenolphthalein indicator*. Dissolve 2.0 g. of phenolphthalein in 100 ml. of pure acetone. (An alcoholic solution is undesirable because the alcohol might react with the anhydride.)

### PROCEDURE

Weigh out accurately an appropriate amount of the sample (e.g., 1.8 g. of acetic anhydride, 0.6 g. of maleic anhydride, 1.1 g. of benzoic anhydride, or 0.7 g. of phthalic anhydride) into a dry, glass-stoppered conical flask, add 20–30 ml. of dry methanol and warm, if necessary, to effect solution. Titrate at room temperature with standard 0.5N sodium methoxide in methanol to a phenolphthalein end point.

Carry out another titration using a second sample of anhydride of approximately equal weight, add 25 ml. of pure pyridine and 25 ml. of water. Titrate at room temperature with standard 0.5N aqueous sodium hydroxide solution to the same end point as used in the first titration. (Some anhydrides, e.g., phthalic anhydride and camphoric anhydride, may require warming to about 60–80° C. to complete the hydrolysis.)

## CALCULATION

Calculate the percentage of anhydride in the sample using the formulae given below.

Let us assume that the sample contains the anhydride, the corresponding acid and a neutral compound, and let

$$\begin{aligned} x &= \text{percentage of anhydride,} \\ y &= \text{percentage of neutral compound,} \\ M_1 &= \text{molecular weight of anhydride, and} \\ M_2 &= \text{molecular weight of acid.} \end{aligned}$$

For an anhydride yielding a monobasic acid (*e.g.*, benzoic anhydride), we have :

Volume (ml.) of  $N \text{ NaOCH}_3$  reacting with anhydride per gram

$$= \frac{1000 \times x}{M_1 \times 100} = \frac{10x}{M_1}$$

Volume (ml.) of  $N \text{ NaOCH}_3$  reacting with any acid present, per gram

$$= \frac{1000 \times (100 - x - y)}{M_2 \times 100} = \frac{10(100 - x)}{M_2} - \frac{10y}{M_2}$$

$\therefore$  Total volume (ml.) of  $N \text{ NaOCH}_3$  reacting with 1 g. of sample

$$= \frac{10x}{M_1} + \frac{10(100 - x)}{M_2} - \frac{10y}{M_2} = a \text{ (say)} \quad (1)$$

where

$$a = \frac{\text{Ml. of NaOCH}_3 \text{ solution} \times \text{Normality}}{\text{Weight of sample (g.)}}$$

Similarly for the titration with aqueous sodium hydroxide :

Volume (ml.) of  $N \text{ NaOH}$  reacting with anhydride per gram

$$= \frac{2000 \times x}{M_1 \times 100} = \frac{20x}{M_1}$$

Volume (ml.) of  $N \text{ NaOH}$  reacting with any acid present, per gram

$$= \frac{1000 \times (100 - x - y)}{M_2 \times 100} = \frac{10(100 - x)}{M_2} - \frac{10y}{M_2}$$

$\therefore$  Total volume (ml.) of  $N \text{ NaOH}$  reacting with 1 g. of sample

$$= \frac{20x}{M_1} + \frac{10(100 - x)}{M_2} - \frac{10y}{M_2} = b \text{ (say)} \quad (2)$$

where

$$b = \frac{\text{Ml. of NaOH solution} \times \text{Normality}}{\text{Weight of sample (g.)}}$$

Subtracting (2) from (1), we obtain :

$$\frac{10x}{M_1} = (b - a)$$

$$\text{or} \quad \text{Percentage of anhydride } x = \frac{(b - a) \times M_1}{10}$$

If a neutral compound is absent, *i.e.*  $y = 0$ , equation (1) reduces to :

$$a = \frac{10x}{M_1} + \frac{10(100 - x)}{M_2} = \frac{10x}{M_1} + \frac{1000}{M_2} - \frac{10x}{M_2}$$

$$\text{or} \quad 10x \left( \frac{1}{M_1} - \frac{1}{M_2} \right) = a - \frac{1000}{M_2} \quad (3)$$

Thus  $x$  can be calculated from the titration result with sodium methoxide solution alone, if only anhydride and acid are present.

For an anhydride yielding a dibasic acid (*e.g.* phthalic anhydride), equation (1) becomes :

$$\frac{10x}{M_1} + \frac{20(100 - x)}{M_2} - \frac{20y}{M_2} = a' \quad (4)$$

and equation (2) becomes :

$$\frac{20x}{M_1} + \frac{20(100 - x)}{M_2} - \frac{20y}{M_2} = b' \quad (5)$$

whence percentage of anhydride  $x = \frac{(b' - a') \times M_1}{10}$

If a neutral compound is absent, *i.e.*  $y = 0$ , equation (4) reduces to :

$$a' = \frac{10x}{M_1} + \frac{20(100 - x)}{M_2} = \frac{10x}{M_1} + \frac{2000}{M_2} - \frac{20x}{M_2}$$

$$\text{or} \quad 10x \left( \frac{1}{M_1} - \frac{2}{M_2} \right) = a' - \frac{2000}{M_2}$$

Since  $M_2 = M_1 + 18$ , the percentage of anhydride  $x$  can be computed from the sodium methoxide titration alone.

Some typical results are given in the following table.

ANHY- DRIDE A	WEIGHT USED	ML. OF N NaOCH <sub>3</sub> PER G. OF A (a)	ML. OF N NaOH PER G. OF A (b)	(b - a) ML. PER G.	% OF ANHYDRIDE FOUND	
					NaOCH <sub>3</sub> ALONE	NaOCH <sub>3</sub> and NaOH
Acetic .	ca. 1.0 g.	10.17	19.49	9.32	94.6	95.1
Maleic .	ca. 0.6 g.	11.60	19.78	8.18	80.6	80.3
Benzoic	ca. 1.1 g.	5.04	8.71	3.67	83.0	82.8
Phthalic	ca. 0.7 g.	6.81	13.51	6.70	99.6	99.5

## XXIV,3.

### DETERMINATION OF ANHYDRIDES WITH MORPHOLINE REAGENTS

*Morpholine reagent.* Dilute 22 ml. of redistilled morpholine (b.p. 129°) to 500 ml. with methanol. The strength is about 0.5N. Store the reagent in a bottle fitted with a 50 ml. delivery pipette (see Fig. XV, 5, 3), and protect it from carbon dioxide and moisture.

*Methanolic hydrochloric acid,* ca. 0.5N. Dilute 21 ml. of concentrated hydrochloric acid to 500 ml. with methanol. Determine the

exact strength by titration with standard 0.5*N* sodium hydroxide solution.

*Mixed indicator.* Dissolve 1.0 g. of methyl yellow (*p*-dimethyl-aminoazobenzene) and 0.1 g. of methylene blue in 125 ml. of methanol.

### PROCEDURE

**Benzoic anhydride.** Measure out 50.0 ml. of the morpholine reagent into a 250 ml. iodine flask ; use a filling device attached to the pipette (see Figs. *XV*, 5, 3 and *XV*, 5, 4). Introduce 2–3 g., accurately weighed, of the sample of benzoic anhydride. Swirl the contents of the flask gently until the solid dissolves, and allow to stand for 5 minutes. Add a few drops of the mixed indicator, and titrate the solution with the 0.5*N* methanolic hydrochloric acid ; at the end point, the colour of the solution changes from green to amber.

Perform a blank titration with 50 ml. of the morpholine reagent. The difference between the volumes for the blank and the sample is a measure of the anhydride content.

**Phthalic anhydride.** Use 50.0 ml. of the morpholine reagent and about 2.0 g., accurately weighed, of the sample of phthalic anhydride. Complete the analysis as for benzoic anhydride.

**Succinic anhydride.** Use 50.0 ml. of the morpholine reagent and about 1.6 g., accurately weighed, of the succinic anhydride. Proceed as for benzoic anhydride.

**Acetic anhydride.** Weigh out accurately about 1.3 g. of the sample of acetic anhydride with the aid of a weighing bottle fitted with a dropper (compare Fig. *XIV*, 1, 5) into 50.0 ml. of the morpholine reagent contained in a 250 ml. iodine flask. Swirl the contents of the flask gently until all the anhydride has passed into solution, and allow to stand for 5 minutes. Titrate the excess of the reagent with the 0.5*N* methanolic hydrochloric acid.

**Propionic anhydride.** Use about 2.0 g., accurately weighed of propionic anhydride and 50.0 ml. of the morpholine reagent. Follow the procedure given for acetic anhydride.

### CALCULATION

Calculate the percentage of anhydride in the sample from the formula :

$$\% \text{ Anhydride} = \frac{(V_1 - V_2) \times N_1 \times M \times 100}{W \times 1000}$$

where  $V_1$  = titration (ml.) of blank ;

$V_2$  = titration (ml.) of sample ;

$N_1$  = normality of methanolic hydrochloric acid ;

$M$  = molecular weight of anhydride ; and

$W$  = weight (g.) of sample.

## CHAPTER XXV

### ESTERS OF CARBOXYLIC ACIDS

#### XXV,1. GENERAL DISCUSSION OF VARIOUS METHODS FOR THE QUANTITATIVE HYDROLYSIS OF CARBOXYLIC ESTERS

The usual method for the determination of esters  $\text{RCOOR}'$  is by saponification with a solution of an alkali hydroxide, *e.g.* :

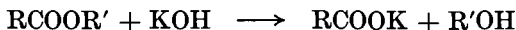

A weighed amount of the ester is heated with a known volume (excess) of the standard alkali hydroxide solution and the excess of alkali is determined, after hydrolysis is complete, by titration with standard acid.

The **saponification equivalent** of an ester is usually defined as the weight of the ester, in grams, which reacts with one gram equivalent of a strong base. The molecular weight of the ester is  $a$  times the saponification equivalent, where  $a$  is the number of ester groups in the molecule.

The hydrolysis may be conducted with three main types of reagent :

(a) *Aqueous sodium or potassium hydroxide.* This reagent is generally used for esters which are soluble in water and are fairly easily saponified.

An interesting application is the determination of the acetyl content of the acetate of a polyhydric alcohol ; if the molecular weight is known, the number of acetyl groups in the sample can be evaluated. The reaction :

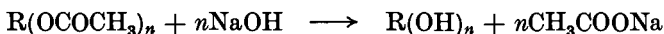

is essentially the reverse of the determination of the hydroxyl content of a hydroxy compound by acetylation with acetic anhydride in pyridine (compare Section XVI,2).

It must be noted that the procedure must be modified for acetylated carbohydrates (*e.g.*, penta-acetyl glucose) since the liberated sugar (*e.g.*, glucose) is slightly resinified by the alkali giving a brown solution, and the colour change of the indicator is consequently difficult to detect. Hydrolysis with excess of standard sulphuric acid, however, proceeds smoothly, and the solution remains colourless ; the residual sulphuric acid and acetic acid may be titrated with standard sodium hydroxide solution to a phenolphthalein end point.

A semimicro procedure for the determination of O-acetyl groups is given in Chapter XXXI.

(b) *Alcoholic sodium or potassium hydroxide solution.* This reagent is used for esters which are insoluble in water and which are fairly easily hydrolysed.

The alcohol normally employed is absolute ethanol, but for esters that are not hydrolysed readily isopropanol, *n*-propanol or *n*-butanol have been recommended. The advantages of the latter are increased speed of saponification due to the higher reflux temperature, their freedom from aldehydes, and the absence of legal restrictions on their sale.

It is appropriate to draw attention to possible alcoholysis (ester transposition) with methanolic or ethanolic alkali hydroxide. When the ester derived from one alcohol is dissolved in another, the second alcohol may replace the first until the reaction attains equilibrium when certain concentrations are reached; hydrolysis occurs subsequently. A volatile methyl or ethyl ester can thus be formed by alcoholysis, and it is therefore essential to employ an efficient reflux condenser even when esters of comparatively high boiling point are hydrolysed. Ester transformation explains the experimental fact that methyl, ethyl, *n*-propyl, *iso*-butyl, *iso*-amyl and benzyl acetates are hydrolysed at exactly the same rate in methanol.

(c) *Potassium hydroxide in diethylene glycol.* The chief advantage of using high boiling point solvents and conducting hydrolyses at their boiling points is that the rate of reaction is increased greatly. Easily saponifiable esters are hydrolysed within a few minutes, whilst difficultly saponifiable ones (*e.g.*, di-*n*-butyl phthalate) are hydrolysed quantitatively within a reasonable time.

For the hydrolysis of difficultly saponifiable esters, refluxing with a 0.8*N* solution of potassium hydroxide in a mixture of about 92 per cent. diethylene glycol and 8 per cent. phenetole by volume has been recommended. The function of the phenetole is to increase the solvent power of the reagent and to provide a blanket of vapour above the reaction mixture which excludes atmospheric oxygen.

Titration is made either by the usual difference technique (involving a blank determination) or by the so-called double-indicator method (W. Riemann III, 1943). The latter consists in cooling the hydrolysis reaction mixture (from, say, 5 g. of ester or oil or fat and 50 ml. of 0.5*N* alcoholic potassium hydroxide), adding phenolphthalein indicator, titrating to the neutral point with standard acid, then adding bromophenol blue indicator and 10 ml. of benzene (the latter leads to a sharper end point), and titrating to a green end point. The standard acid added between the two end points is equivalent to the salt formed, *i.e.*, to the potassium hydroxide which reacted with the sample during the



saponification. The reaction which occurs while titrating with standard acid from one end point to the other may be expressed as :

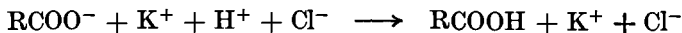

Instead of determining the volume of alkali hydroxide solution utilised in the saponification, the reaction product (after hydrolysis) is diluted with methanol-water and passed through a cation exchange column in the hydrogen form. The excess of potassium or sodium hydroxide is neutralised, and the carboxylate ion is converted into the free carboxylic acid. The carboxylic acid is then titrated directly with standard aqueous sodium hydroxide solution.

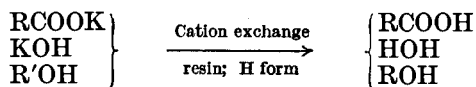

Full experimental details will be found in Chapter XXXVI.

## XXV,2.            HYDROLYSIS BY AQUEOUS SODIUM HYDROXIDE. ANALYSIS OF ACETYL ESTERS

### REAGENTS

*Aqueous sodium hydroxide solution, 0.5N.*

*Aqueous hydrochloric acid, 0.5N.*

*Phenolphthalein indicator. See Section XXII,2.*

### PROCEDURE

Fit two 250 ml. conical flasks with reflux water condensers by means of rubber stoppers. Introduce 4–8 milli-mols, accurately weighed, of the ester (*e.g.*, about 1.0 g. of mannitol hexa-acetate  $\text{C}_6\text{H}_5(\text{OCOCH}_3)_6$ , or about 2.0 g. of glycerol triacetate  $\text{C}_3\text{H}_5(\text{OCOCH}_3)_3$ ) into one flask. Pipette 50.0 ml. of 0.5N sodium hydroxide solution into each flask (one flask acts as a blank), and add a few minute fragments of carborundum to each flask. Boil each flask very gently under reflux for 30 minutes; if any ester enters the condenser, wash it down with a little water. Stop the heating, and pour 10–15 ml. of distilled water down each condenser to wash any solution back into the flask. Remove the flasks and cool in cold water. Titrate the contents of each flask with standard 0.5N hydrochloric acid, using phenolphthalein as indicator.

## CALCULATION

Calculate the percentage of acetyl in the sample from the formula :

$$\% \text{ Acetyl} = \frac{(V_1 - V_2) \times 43.04 \times 100}{W \times 2000}$$

where  $V_1$  = volume (ml.) of 0.5*N* HCl used in blank ;  
 $V_2$  = volume (ml.) of 0.5*N* HCl used for sample ; and  
 $W$  = weight (g.) of sample.

2000 Ml. of 0.5*N* HCl  $\equiv$  2000 Ml. of 0.5*N* NaOH  $\equiv$  1 Mol NaOH  $\equiv$  1 Acetyl group  $\equiv$  43.04 g. CH<sub>3</sub>CO.

If the molecular weight  $M$  of the compound is known, the number of acetyl groups  $n$  is given by :

$$n = \frac{(V_1 - V_2) \times M}{W \times 2000}$$

### XXV,3. HYDROLYSIS BY ALCOHOLIC SODIUM OR POTASSIUM HYDROXIDE. ANALYSIS OF EASILY SAPONIFIED ESTERS

#### REAGENTS

*Alcoholic potassium hydroxide solution*, ca. 0.5*N*. Dissolve 6 g. of A.R. potassium hydroxide pellets in 250 ml. of 95 per cent. ethanol, and allow to settle overnight. Decant or filter the clear solution from any insoluble potassium carbonate. Standardise the solution with standard 0.5*N* or 0.25*N* hydrochloric acid or with A.R. potassium hydrogen phthalate, using phenolphthalein as indicator.

*Alcoholic sodium hydroxide solution*, ca. 0.5*N*. Place 250 ml. of absolute ethanol in a litre flask fitted with a Liebig condenser. Add 3 g. of clean sodium, cut into small pieces, through the condenser gradually ; moderate the reaction, if necessary, by momentary immersion of the flask in cold water. When all the sodium has reacted, add 25 ml. of water and mix well. Store in a glass-stoppered or rubber-stoppered bottle. Standardise just before use as for 0.5*N* alcoholic potassium hydroxide.

*Phenolphthalein indicator*. See Section XXII,2.

#### PROCEDURE

Fit two 250 ml. conical flasks with efficient reflux condensers by means of rubber stoppers (1). Weigh out accurately (2) about 5 milli-mols of the ester (e.g., 0.5 g. of ethyl *n*-butyrate) into one flask. Introduce 25.0 ml. of 0.5*N* alcoholic potassium or sodium hydroxide by means of a pipette or burette into each flask (one flask acts as a blank or control), and add a few small fragments of carborundum to each flask. Boil each flask gently under efficient reflux for 30–40 minutes. Pour 20–25 ml. of water

down each condenser (3), remove the flasks from the respective condensers, and cool in cold water. Titrate the contents of each flask with standard 0.5*N* (or 0.25*N*) hydrochloric acid, using phenolphthalein as indicator. The end point should be a faint pink. Alternatively, titrate the solution until the phenolphthalein is colourless, and then back titrate with the original alcoholic alkali solution.

#### Notes.

(1) Bark corks must not be used since the alcohol vapour extracts substances which react with alkali. The rubber stoppers should preferably be warmed with dilute alkali, and then thoroughly washed with distilled water. Ground glass joints may also be used but special precautions must be taken to prevent "sticking".

(2) Use the "pipette" weighing bottle shown in Fig. XIV, 1, 5, and weigh by difference.

(3) If the condenser is fitted into the flask by means of a ground glass joint, remove the flask from the condenser immediately after the water has been added; no difficulty will be experienced and no "sticking" or "freezing" of the ground joint should occur.

### CALCULATION

Calculate the saponification equivalent of the ester from the formula :

$$\text{Saponification equivalent} = \frac{W \times 1000}{(V_1 - V_2) \times N_1}$$

where  $W$  = weight (g.) of sample ;

$V_1$  = volume (ml.) of acid required for blank ;

$V_2$  = volume (ml.) of acid required for sample ; and

$N_1$  = normality of hydrochloric acid.

2000 MI. of 0.5*N* KOH  $\equiv$  2000 MI. of 0.5*N* HCl  $\equiv$  Saponification equivalent of ester.

Alternatively, if the molecular weight  $M$  of the ester is known, calculate the purity of the ester :

$$\% \text{ Ester} = \frac{(V_1 - V_2) \times M \times 100}{W \times 1000}$$

## XXV,4. HYDROLYSIS BY POTASSIUM HYDROXIDE IN DIETHYLENE GLYCOL. ANALYSIS OF DIFFICULTLY SAPONIFIABLE ESTERS

### REAGENTS

*Potassium hydroxide in diethylene glycol*, ca. 0.5*N*. Weigh out about 7 g. of A.R. potassium hydroxide pellets into a 250 ml. flask, and then add 100 ml. of redistilled diethylene glycol. Warm to about 60° C. to effect solution whilst stirring with a thermometer : do not permit the temperature to exceed 100°, otherwise the reagent will be coloured and

thus lead to difficulties in the titration. Cool to room temperature, pour the solution into 150 ml. of redistilled diethylene glycol in a glass-stoppered bottle. Mix the solution thoroughly. The solution may also be prepared by stirring mechanically at room temperature for a few hours.

Standardise the solution by titrating a 25 ml. portion with standard 0.5*N* hydrochloric acid, using phenolphthalein as indicator.

*Hydrochloric acid, 0.5N.*

*Phenolphthalein indicator.* See Section XXII,2.

### PROCEDURE

Transfer, by means of a suitable pipette (1), 25.0 ml. of the reagent into each of two 150 ml. glass-stoppered flasks (2). Keep one flask as a blank, and weigh accurately (3) about 5 milli-mols of the ester (*e.g.*, 0.7 g. of benzyl acetate or 1.4 g. of di-*n*-butyl phthalate) into the other. Mix the reagent and ester by a rotary motion of the flask and contents. Hold the glass stopper firmly in place and heat the mixture in an oil bath so that a temperature of 70–80° is reached in 2 or 3 minutes. Remove the flask from the bath and shake vigorously whilst still holding the stopper in position: this will dissolve any vapourised ester. Allow the liquid to drain, and then cautiously loosen the stopper in order that air may escape. Replace the stopper and continue the heating until the temperature is 120–130°. [With esters of very high boiling point, such as di-*n*-butyl phthalate, the stopper may be removed and a thermometer inserted.] Heat for 3 minutes at 120–130°, cool the flask and contents to 80–90°, remove the stopper, wash it with distilled water, and allow the rinsings to drain into the flask. Dilute with 30–40 ml. of distilled water, add phenolphthalein indicator, and titrate with standard 0.5*N* (or 0.25*N*) hydrochloric acid.

Calculate the saponification equivalent or the purity of the ester as in Section XXV,3.

#### Notes.

(1) It is advisable, because of the viscosity of the reagent, to open the tip of the pipette to a diameter of 2–3 mm. The pipette will require recalibration.

(2) An iodine flask may also be used and is, indeed, highly convenient. If the ester is particularly difficult to saponify (*e.g.*, fats and oils), refluxing for periods of the order of 2 hours and at temperatures up to 175° may be required. In such cases, the flask should be attached to a reflux condenser by means of a ground glass joint.

(3) Use the "pipette" weighing bottle shown in Fig. XIV, 1, 5, and weigh by difference.

## CHAPTER XXVI

### ALDEHYDES AND KETONES

#### XXVI.1. DISCUSSION OF SELECTED METHODS FOR THE DETERMINATION OF ALDEHYDES AND KETONES

The following methods are described :—

(a) *Hydroxylamine hydrochloride-pyridine procedure for aldehydes and ketones.* The most general procedure available for aldehydes and ketones is based on the oximation reaction :

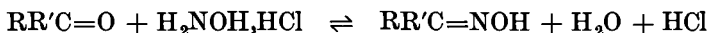

The equilibrium of the reversible reaction is displaced to the right in the presence of pyridine and of excess of hydroxylamine hydrochloride, and the reaction may be regarded as virtually complete. The pyridine combines with the hydrogen chloride to form pyridine hydrochloride :

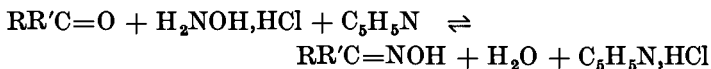

Pyridine hydrochloride is sufficiently acidic to be titrated with standard sodium hydroxide using bromophenol blue as indicator : the initial reagent (which contains hydroxylamine hydrochloride, 80–90 per cent. ethanol and pyridine) is neutral to this indicator.

The rate of reaction between a carbonyl compound and hydroxylamine varies somewhat, depending upon the groups R and R' : some compounds (*e.g.*, propionaldehyde, furfuraldehyde, benzaldehyde and acetone) react quantitatively in 30 minutes at the laboratory temperature, whilst others (*e.g.*, acetophenone, benzophenone, benzoin and camphor) may require heating for 2 hours at 98–100° C. for complete reaction. The method is not applicable to carboxylic acids and to amides.

(b) *Sodium sulphite-sulphuric acid procedure for aldehydes.* The bisulphite reaction

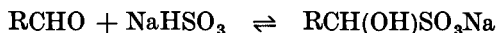

has been used as the basis for an analytical method for the determination of aldehydes. Excess of sodium bisulphite solution was added to the solution of the aldehyde and the residual bisulphite determined iodimetrically. The analysis is subject to various errors associated with the reversibility of the reaction and the instability of sodium bisulphite solution. Another procedure is based upon the reaction between aldehydes and sodium

sulphite solution, followed by titration of the sodium hydroxide formed with standard mineral acid :

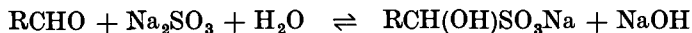

Here, too, experimental difficulties arise owing to the reversible character of the reaction, the comparative slowness of the reaction, and the buffering effect of the medium upon indicators. The problem may be largely solved by the addition of a known volume of standard sulphuric acid to a large excess of sodium sulphite solution immediately before the aldehyde sample is introduced. The aldehyde reacts with the sodium bisulphite

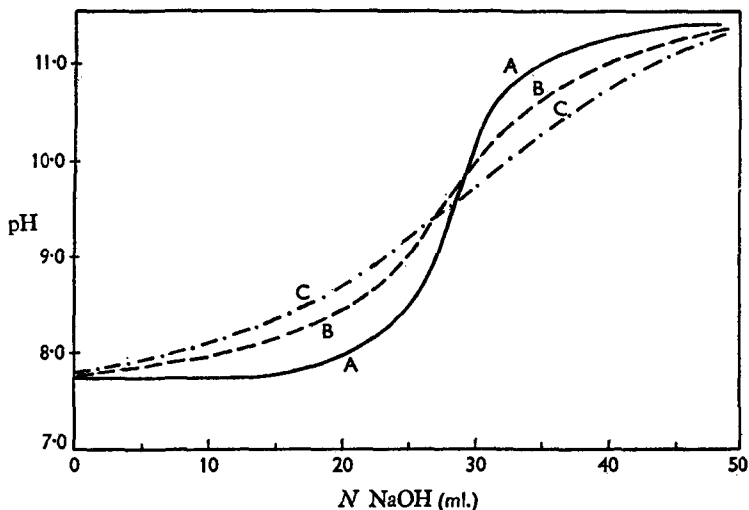
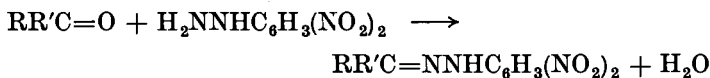

Fig. XXVI, 1, 1.

generated *in situ*, and the excess of bisulphite is titrated with standard alkali. (Alternatively, the reaction can be regarded as being forced to completion, from left to right, by the interaction of the sulphuric acid with the sodium hydroxide.) The large excess of sulphite ensures complete reaction as the excess of bisulphite is titrated with alkali. Because of the difficulties arising from the buffering effect of the sulphite - bisulphite mixture, the end point is best determined with a *pH* meter : *pH* is plotted as ordinates against ml. of standard alkali solution as abscissae, and the end point is determined from the resulting curve. Some typical titration curves are shown in Fig. XXVI, 1, 1 : *A* is the curve obtained for most aldehydes ; *B* is typical of the curve given by benzaldehyde or *cyclohexanone*, leading to a poor end point ; *C* is typical for *furfuraldehyde* and for most ketones,

no break is detectable and the end point cannot be determined. The values for the  $pH$  at the end point for some aldehydes are : acetaldehyde, 9.1 ; propionaldehyde, 9.4 ; *n*-butyraldehyde, 9.4 ; crotonaldehyde, 9.3\* ; benzaldehyde, 8.9 ; and cinnamaldehyde, 9.5\*. Once the  $pH$  at the end point for a particular aldehyde has been evaluated from the titration curve, titration to the pre-determined  $pH$  value usually suffices.

(c) *Gravimetric procedure using 2 : 4-dinitrophenylhydrazine.* The standard identification reaction for carbonyl compounds with 2 : 4-dinitrophenylhydrazine is employed :



A large excess (150–200 per cent.) of the reagent (a saturated solution of 2 : 4-dinitrophenylhydrazine in aqueous 2*N* hydrochloric acid) is used, and the precipitate is collected after standing at room temperature or, better, at 0° C. for 1 hour. The derivative can usually be dried at 100–110° C. but for low melting products, drying at room temperature in a vacuum desiccator is recommended.

The procedure described below is designed for water-soluble compounds only. The amount of carbonyl compound required (0.02–0.04 milli-mol) is so small that even slightly soluble compounds can be analysed in this way.

Acetals and ketals can be determined, since the acidic reagent will hydrolyse them to the corresponding aldehydes and ketones.

## XXVI.2. DETERMINATION OF ALDEHYDES AND KETONES BY THE HYDROXYLAMINE HYDROCHLORIDE - PYRIDINE PROCEDURE

### REAGENTS

*Hydroxylamine hydrochloride solution*, ca. 0.5*N*. Dissolve 35 g. of pure hydroxylamine hydrochloride in 160 ml. of distilled water, and dilute to 1 litre with 95 per cent. ethanol.

*Pyridine-indicator solution.* Mix 0.25 ml. of a 4 per cent. solution of bromophenol blue in alcohol with 20 ml. of pure pyridine, and dilute to 1 litre with 95 per cent. ethanol.

*Methanolic sodium hydroxide solution*, ca. 0.5*N*. Dissolve 20 g. of A.R. sodium hydroxide pellets in 100 ml. of distilled water, and dilute to 1 litre with absolute methanol. Standardise with standard 0.5*N* hydrochloric acid using bromophenol blue as indicator, or with A.R. potassium hydrogen phthalate.

\* Two mols of bisulphite are required per mol of aldehyde.

### PROCEDURE

Place 30 ml. of the hydroxylamine hydrochloride reagent and 100 ml. of the pyridine-indicator solution in a 250 ml. glass-stoppered flask (an iodine flask is suitable) and add not more than 10 milli-equivalents of the aldehyde or alicyclic ketone (*e.g.*, 1.1–1.4 g. of redistilled furfural, or redistilled benzaldehyde, or *p*-nitrobenzaldehyde or *cyclohexanone*), accurately weighed, to the contents of the flask (1). Stopper the flask, and allow it to stand at the laboratory temperature for 30 minutes. Meanwhile, carry out a blank determination, omitting the addition of the carbonyl compound, and titrate with the 0.5*N* methanolic sodium hydroxide to a blue-green colour: keep the resulting solution for use as a colour standard. Now titrate the hydrochloric acid liberated during the oximation of the sample with the 0.5*N* methanolic sodium hydroxide until the colour of the solution matches that of the blank (2); a little experience is required before accurate colour matching is achieved.

Oxime formation is rather slow for most, particularly aromatic, ketones. To gain experience with such ketones, place 30 ml. of the hydroxylamine hydrochloride reagent and 100 ml. of the pyridine-bromophenol blue solution in a 250 ml. conical flask fitted with a ground-in condenser. Weigh out accurately not more than 10 milli-equivalents of the ketone (*e.g.*, about 1.0 g. of benzophenone, benzoin, acetophenone or benzil) into the flask. Heat the mixture on a boiling water bath for 2 hours; allow to cool. Titrate the liberated hydrochloric acid with the 0.5*N* methanolic sodium hydroxide until the colour of the indicator matches that of the blank subjected to the same experimental conditions.

#### Note.

(1) The weight of the sample should be such that at least one third, and preferably one half, of the hydroxylamine reagent will remain when the carbonyl compound has reacted completely.

(2) Alternatively, the end point may determined potentiometrically. Titrate with the 0.5*N* sodium hydroxide to an apparent *pH* of 3.80, using glass and calomel electrodes and a commercial *pH* meter.

### CALCULATION

Calculate the percentage purity of the carbonyl compound from the formula:

$$\% \text{ Carbonyl compound} = \frac{V_1 \times N_1 \times M \times 100}{W \times 1000}$$

where  $V_1$  = volume (ml.) of sodium hydroxide solution used for sample;  
 $N_1$  = normality of methanolic sodium hydroxide;  
 $M$  = molecular weight of carbonyl compound; and  
 $W$  = weight (g.) of sample.



### XXVI.3. DETERMINATION OF ALDEHYDES BY THE SODIUM SULPHITE - SULPHURIC ACID PROCEDURE

#### REAGENTS

*Sodium sulphite solution, 1M.* Prepare a 1M solution of sodium sulphite and adjust the pH of the solution to 9.1 by the dropwise addition, with stirring, of a 1M solution of sodium bisulphite. Use a pH meter and a glass - calomel electrode system.

*Standard 1N sulphuric acid.*

*Standard 1N sodium hydroxide solution.*

#### PROCEDURE

Place 250 ml. of the 1M sodium sulphite solution in a 500 ml. glass-stoppered bottle or flask, and cautiously add 50.0 ml. of N sulphuric acid: swirl the contents of the flask gently as the acid is added in order to avoid loss of sulphur dioxide due to localised overneutralisation of the sodium sulphite. To the resulting solution add the sample, accurately weighed, containing 20-30 milli-equivalents of the aldehyde (*e.g.*, 2.0 g. of redistilled *n*-butyraldehyde or 3.0 g. of redistilled *n*-heptaldehyde) (1). Shake the mixture vigorously for about 15 minutes. Transfer the reaction mixture quantitatively with the aid of a few ml. of water to a 600 ml. beaker; stir magnetically. Introduce a glass and a calomel electrode into the solution, and connect the electrodes to a pH meter. Titrate the excess of acid with N sodium hydroxide solution. Plot the pH readings (ordinates) against ml. of alkali added (abscissae), and evaluate the end point from the plot.

A more rapid method, although somewhat less precise, is to add the standard alkali until a pH is obtained corresponding to the pH at the end point for the aldehyde being analysed. The end point pH values for a number of aldehydes are given in Section XXVI.1, but it is usually better to determine the figure for each aldehyde and to employ the value so obtained in all subsequent determinations with the particular aldehyde. Thus the author found values of 9.3 and 9.0 for *n*-butyraldehyde and *n*-heptaldehyde respectively.

#### Note.

(1) Volatile aldehydes may be added in a sealed glass ampoule.

#### CALCULATION

Calculate the percentage purity of the aldehyde from the formula:

$$\% \text{ Purity} = \frac{(V_1 - V_2) \times N_1 \times M \times 100}{W \times 1000}$$

where  $V_1$  = calculated volume (ml.) of standard  $N$  NaOH required to neutralise the 50.0 ml. of standard  $N$   $H_2SO_4$  ;  
 $V_2$  = volume (ml.) of  $N$  NaOH used to titrate the sample ;  
 $N_1$  = exact normality of the NaOH solution ;  
 $M$  = molecular weight of aldehyde ; and  
 $W$  = weight (g.) of sample.

## XXVI.4. DETERMINATION OF CARBONYL COMPOUNDS WITH 2 : 4-DINITROPHENYLHYDRAZINE

### REAGENTS

*2 : 4-Dinitrophenylhydrazine reagent.* This consists of a saturated solution of pure 2 : 4-dinitrophenylhydrazine in  $2N$  aqueous hydrochloric acid at  $0^\circ$ . The reagent contains about 4 mg. of the solid per ml.

*Hydrochloric acid, 2N.*

### PROCEDURE

Place 50–60 ml. of the reagent in a 250 ml. glass-stoppered conical flask, and add 0.02–0.04 milli-mol, accurately weighed, of the sample. Shake the flask for 2–3 minutes to ensure that the carbonyl compound dissolves ; allow to stand for 1 hour in an ice bath, shaking occasionally. Decant through a weighed sintered glass crucible (porosity G3), wash once by decantation with  $2N$  hydrochloric acid, transfer the precipitate to the crucible, and wash it with  $2N$  hydrochloric acid, followed by water. Dry to constant weight at  $100$ – $105^\circ$  or in a vacuum desiccator over concentrated sulphuric acid.

### CALCULATION

Calculate the percentage purity of the carbonyl compound from the formula :

$$\% \text{ Purity} = \frac{w \times F \times 100}{W}$$

where  $w$  = weight (g.) of 2 : 4-dinitrophenylhydrazone ;  
 $F$  = gravimetric factor ; and  
 $W$  = weight (g.) of sample.

## CHAPTER XXVII

### CARBOHYDRATES (SUGARS)

#### XXVII.1. DETERMINATION OF ALDOSES BY TITRATION WITH STANDARD IODINE AND STANDARD ALKALI

##### THEORY

The determination of aldose sugars by titration with iodine-alkali reagents is based upon the following reaction :

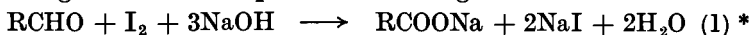

Iodine also reacts with caustic alkali to form sodium iodate, which takes no part in the sugar-oxidation reaction :

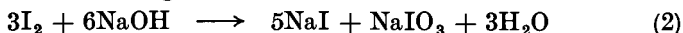

To obtain accurate results the alkali must be added slowly to the solution of the aldose sugar containing a small amount of iodine solution : under these conditions, the oxidation of the sugar takes place preferentially, *i.e.*, (1) is the main reaction. By the addition of iodine and alkali successively in small portions, the concentration of the sugar relative to the iodine-alkali or sodium hypoiodite is kept at a level favouring the sugar-oxidation reaction. The rapid formation of iodate, therefore, indicates the complete oxidation of the aldose. By this procedure only 2-3 ml. excess of 0.1*N* iodine is required per milli-mol of aldose and the danger of over-oxidation is almost entirely eliminated. In slightly alkaline solution (*pH* about 9-10), the end point of the reaction is reached within about 2 minutes after the last portions of the reagents are added. For one milli-mol of aldose sugar, the theoretical quantities of 0.1*N* iodine and 0.1*N* sodium hydroxide are 20.00 ml. and 30.00 ml. respectively ; the quantities recommended are 22 ml. and 35 ml. respectively with a total reaction time of 8-10 minutes. The amount of aldose present can be calculated from either (or both) the iodine or the alkali consumed ; in practice, the determination of the iodine solution consumed usually suffices.

Mannose is oxidised by hypoiodite at about one quarter the rate of glucose and in consequence serious errors may result by the use of the above procedure. Satisfactory analyses are obtained by replacing the sodium hydroxide solution by sodium carbonate solution and using a larger excess of iodine.

\* The effective oxidising agent is probably hypoiodous acid (a very weak acid), produced by the hydrolysis of iodine :

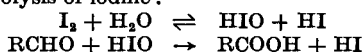

XXVII,2. DETERMINATION OF ALDOSES  
BY TITRATION WITH STANDARD IODINE  
AND STANDARD ALKALI.  
EXPERIMENTAL PROCEDURE

REAGENTS

*Standard iodine solution, 0·1N.* See Section XXII,4.

*Standard sodium thiosulphate solution, 0·1N.* See Section XVIII,3.

*Standard sodium hydroxide solution, 0·1N.*

*Standard hydrochloric acid, 0·1N.*

*Starch indicator solution.* See Section XVII,2.

*Phenolphthalein indicator solution.* Dissolve 0·05 g. of phenolphthalein in 50 ml. of ethanol and dilute with 50 ml. of water.

PROCEDURE

The general procedure consists in using a weighed amount of the sample (*e.g.*, one milli-mol of an aldose sugar) or an aliquot of the sugar solution which will react with about 20 ml. of 0·1N iodine. Titrate the solution, if necessary, with 0·1N sodium hydroxide or hydrochloric acid until it is neutral to phenolphthalein indicator (use 1 drop only of the indicator solution). Add 5 ml. of 0·1N iodine from a burette, then add dropwise from another burette, with thorough mixing of the solutions, 7·5 ml. of 0·1N sodium hydroxide. Repeat the process until 22 ml. of iodine solution and 35 ml. of alkali solution have been run in. This operation should be complete in about 6 minutes. Allow to stand for a further 2–5 minutes for the completion of the oxidation. Acidify with 0·1N hydrochloric acid to liberate iodine from any sodium iodate present, and titrate the resulting iodine with 0·1N sodium thiosulphate, using starch solution as indicator. Add 2–3 drops of phenolphthalein indicator, and titrate the excess of acid with 0·1N sodium hydroxide.

If the iodine liberated by acidification requires more than about 3 ml. of 0·1N sodium thiosulphate, too much iodine has been added and over-oxidation of the aldose may ensue. For the most accurate results, repeat the experiment and deduct the volume of thiosulphate solution less 2 ml. from the volume of iodine solution first added to the unknown. If the volume of thiosulphate solution required after acidification is less than 1·5 ml., the amount of iodine solution added is generally insufficient: the experiment should be repeated using more iodine solution and alkali solution.

The volume (ml.) of 0·1N iodine minus the volume (ml.) of 0·1N sodium thiosulphate, and the number of ml. of 0·1N sodium hydroxide minus the number of ml. of 0·1N hydrochloric acid give the quantities of 0·1N iodine and 0·1N sodium hydroxide used in the oxidation of the aldose sugar. One milli-mol of the aldose sugar requires for oxidation 20·00 ml. of 0·1N iodine and 30·00 ml. of 0·1N sodium

hydroxide. Either the iodine or alkali consumed, or both as checks, may be used to calculate the weight of aldose present.

For experience in the above analysis, the student should determine the purity of samples of glucose, galactose, xylose, maltose or lactose. Weigh out accurately about 10 milli-mols of one of the above sugars, and dissolve in 250 ml. of water in a volumetric flask. Check that the solution is neutral to phenolphthalein. Pipette 25.0 ml. of the solution into a 250 ml. conical flask. Add 5 ml. of 0.1*N* iodine from a burette. Then add dropwise from a burette 7.5 ml. of 0.1*N* sodium hydroxide; stir the solution vigorously (preferably with a magnetic stirrer) to avoid localised concentration of alkali. Repeat the process until 22 ml. of iodine solution and 35 ml. of alkali solution have been run in; record the exact volumes. This operation will occupy about 6 minutes. Allow to stand for a further 2-5 minutes for the completion of the oxidation. Acidify with about 15 ml. of 0.1*N* hydrochloric acid to free the iodine from the sodium iodate present: titrate the liberated iodine with 0.1*N* sodium thiosulphate, using starch indicator solution. Add 2-3 drops of phenolphthalein indicator, and titrate the excess of acid with 0.1*N* sodium hydroxide.

### CALCULATION

Calculate the purity of the aldose from the simple relationship:

$$\% \text{ Aldose} = \frac{\text{Wt. of milli-mol}}{\text{Wt. of sample}} \times \frac{\text{Ml. of reagent used} \times 100}{\text{Ml. of reagent required per milli-mol}}$$

The volumes required per milli-mol are 20.00 ml. of 0.1*N* iodine and 30.00 ml. of 0.1*N* sodium hydroxide.

Alternatively, use the following general formulae:

$$\% \text{ Aldose} = \frac{V_1 \times N_1 \times M \times 100}{W \times 2 \times 1000} \quad (1)$$

where  $V_1$  = volume (ml.) of thiosulphate solution equivalent to iodine solution consumed by sample;

$N_1$  = normality of sodium thiosulphate solution;

$M$  = molecular weight of aldose; and

$W$  = weight (g.) of sample.

$$\text{or} \quad \% \text{ Aldose} = \frac{V_1 \times N_1 \times M \times 100}{W \times 3 \times 1000} \quad (2)$$

where  $V_1$  = volume (ml.) of sodium hydroxide solution of normality  $N_1$  consumed by sample.

#### Note.

The following procedure should be used for the *determination of mannose*. Weigh out accurately about 12.5 milli-equivalents (0.225 g.) of the sample, add 55.0 ml. of  $N$  sodium carbonate solution and 55.0 ml. of standard 0.1*N*

iodine solution (the latter containing 60 g. of potassium iodide per litre); mix well. Keep the solution at about 20° C for 30 minutes, and then acidify with 6*N* hydrochloric acid. Titrate the excess of iodine with standard 0·1*N* sodium thiosulphate solution. Run a blank determination and thus evaluate the volume of iodine solution consumed in the oxidation of the aldose.

Calculate the purity of the mannose.

### XXVII.3. DETERMINATION OF REDUCING SUGARS WITH THE AID OF FEHLING'S SOLUTION

#### THEORY

Alkaline solutions of copper salts, *e.g.*, Fehling's solution, are reduced by aldose sugars to cuprous oxide. The reduction is not stoichiometric, consequently all methods for the determination of reducing sugars are empirical and the results are affected by slight variations in procedure. Nevertheless, the results are trustworthy if the experimental details are adhered to, or if standardisation is effected under identical conditions with solutions of the pure sugar.

A rapid method for the determination of sugars is required for the analysis of biological fluids and it is for this purpose that Fehling's solution has its widest application. The fact that the procedure is not an absolute one (compare Section XXVII,2) is of secondary importance in biochemical work provided trustworthy results can be obtained in the minimum of time; the use of an empirical factor or reference to tables is, of course, necessary.

The Fehling's solution employed is that known as Soxhlet's modification and is prepared as follows.

**Preparation of Fehling's solution.**—*Solution No. 1.* Dissolve 34·64 g. of A.R. crystallised copper sulphate,  $\text{CuSO}_4 \cdot 5\text{H}_2\text{O}$ , in water and make up the solution to 500 ml. in a volumetric flask.

*Solution No. 2.* Dissolve 173 g. of Rochelle salt (sodium potassium tartrate) and 50 g. of sodium hydroxide in water, cool, and dilute to 500 ml. in a volumetric flask.

When Fehling's solution is required, transfer equal volumes of Solutions 1 and 2 to a dry flask and mix thoroughly. Fehling's solution deteriorates slowly on keeping, consequently only sufficient should be prepared to meet immediate requirements.

Fehling's solution may be standardised with pure anhydrous glucose (or any other pure reducing sugar) by several methods:—

(a) By treating 10·0 or 25·0 ml. of the solution with a solution of pure glucose, using methylene blue as an indicator near the end of the reaction. The dye is reduced to a colourless compound immediately an excess of the carbohydrate is present. The internal indicator is so sensitive that the end point can be determined to within one drop of the sugar solution in many cases.

(b) Excess of the Fehling's solution is added to the solution of the sugar. The residual cupric copper is determined by acidifying with dilute sulphuric acid, adding excess of potassium iodide solution, and titrating the liberated iodine immediately with 0.1*N* sodium thiosulphate solution. By performing a blank experiment with the Fehling's solution, the amount of the latter which has reacted with the sugar may be calculated.

(c) This procedure is similar to (b) except that the cuprous oxide is filtered off on a quantitative filter paper, and the cupric salt in the filtrate determined with the aid of titanous chloride solution (compare Chapter XXVIII). The filtrate is acidified with dilute sulphuric acid, excess of standard titanous chloride solution added, and the residual titanous salt is titrated with a solution of ferric alum using ammonium thiocyanate as indicator.

Experimental details will be given for methods (a) and (b) only.

It is found that 1 ml. of the above Fehling's solution is equivalent to :

- 0.00501 g. of glucose
- 0.00532 g. of fructose
- 0.00431 g. of mannose
- 0.00678 g. of lactose ( $C_{12}H_{22}O_{11} \cdot H_2O$ )
- 0.00800 g. of maltose ( $C_{12}H_{22}O_{11} \cdot H_2O$ )
- 0.00475 g. of sucrose, after "inversion".

## XXVII.4. DETERMINATION OF REDUCING SUGARS WITH THE AID OF FEHLING'S SOLUTION

### EXPERIMENTAL PROCEDURES

(i) **Standardisation of Fehling's solution with pure glucose, using methylene blue as an internal indicator.** Prepare 100 ml. of Fehling's solution by mixing 50.0 ml. each of Solutions 1 and 2 (Section XXVII,3).

Weigh out accurately about 1.25 g. of dry A.R. glucose, dissolve it in water and dilute to 250 ml. in a volumetric flask. Transfer 25.0 ml. of the freshly prepared Fehling's solution to a 250 ml. conical flask, dilute with an equal volume of water, heat to boiling and add the glucose solution from a burette until the blue colour of the solution just disappears: this will give an approximate value of the volume of glucose solution required. To obtain the exact value, repeat the titration and add so much of the glucose solution that 0.5-1 ml. will be required to complete the reduction. Heat the liquid to boiling, maintain gentle ebullition for 2 minutes and then, without removal of the flame beneath the flask, add 3-5 drops of a 1 per cent. aqueous solution

of methylene blue. Complete the titration in one minute more by adding the glucose solution dropwise until the colour of the methylene blue just disappears. Repeat the titration until consistent values (*i.e.*, values which do not differ by more than 0.1 ml. of glucose solution) are obtained.

Calculate the weight of glucose equivalent to 1 ml. of Fehling's solution.

(ii) **Standardisation of Fehling's solution with pure glucose—iodometric method.** Prepare a standard solution of glucose as in (i). Pipette 25.0 ml. of the freshly-prepared Fehling's solution into a 250 ml. conical flask, add 20.0 ml. of the glucose solution, dilute with 25 ml. of distilled water, heat to gentle boiling, and maintain at the boiling point for 3 minutes. Cool rapidly to room temperature by directing a stream of cold water from the tap on to the flask, add 20 ml. of 6*N* sulphuric acid, followed by 10 per cent. potassium iodide solution (w/v). Mix the contents of the flask by swirling, and titrate immediately with standard 0.1*N* sodium thiosulphate solution: add 1–2 ml. of starch solution indicator when the liquid has acquired a pale straw colour, and continue the titration until the blue colour just disappears. Perform a blank titration with 25.0 ml. of the Fehling's solution, but omitting the glucose solution.

Calculate the weight of glucose equivalent to 1 ml. of 0.1*N* sodium thiosulphate solution and also to 1 ml. of Fehling's solution. Compare the result with that obtained in (i).

**Determination of the purity of a sample of glucose.** This is clearly the reverse of the standardisation (i) or (ii). Weigh out accurately about 0.50 g. of the sample, dissolve it in water, and dilute the solution to 100 ml. in a volumetric flask. Titrate this solution against 25.0 ml. of the Fehling's solution as in methods (i) or (ii).

Calculate the purity of the sample of glucose.

**Determination of the purity of a sample of sucrose.** The non-reducing sucrose must first be "inverted", *i.e.*, converted into a mixture of the two reducing sugars glucose and fructose, by dilute acid:

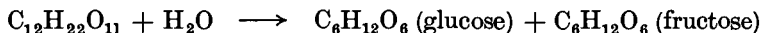

*i.e.*, 342 g. of sucrose  $\equiv$  360 g. of "invert" sugar.

Weigh out accurately about 1.3 g. of the sample of cane sugar, dissolve it in 20 ml. of distilled water in a small conical flask, add 10 ml. of 0.5*N* hydrochloric acid, and heat on a boiling water bath for 20 minutes. Cool, neutralise by adding 10 ml. of 0.5*N* sodium hydroxide solution, and dilute to 250 ml. with boiled-out distilled water in a volumetric flask. Titrate 25.0 ml. of the



standardised Fehling's solution with the "invert" sugar solution, using either method (i) or (ii).

Calculate the purity of the sucrose utilising the pre-determined factors for the Fehling's solution obtained with pure glucose, and noting that 360 g. of "invert" sugar  $\equiv$  342 g. of sucrose.

**Note.**

The above procedures can readily be adapted to the analysis of other reducing sugars.

## CHAPTER XXVIII

### NITRO, NITROSO AND AZO GROUPS. REDUCTION WITH TITANOUS SALTS

#### XXVIII.1. GENERAL DISCUSSION OF THE DETERMINATION OF NITRO, NITROSO AND AZO GROUPS BY REDUCTION WITH TITANOUS SALTS

The use of solutions of titanous chloride and of titanous sulphate for the quantitative reduction of selected organic compounds was first studied by E. Knecht and E. Hibbert in 1903 and was later extended by other workers.

Nitro groups are reduced to amines :

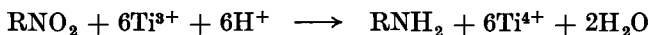

The compound is dissolved in water, alcohol or acetic acid, and an excess of the solution of the titanous salt added : after the reaction mixture has been boiled in a current of inert gas (carbon dioxide or nitrogen), the excess of titanous salt is titrated with standard ferric ammonium sulphate solution, using ammonium thiocyanate solution as indicator. The  $\text{NO}_2$  content of the sample can then be calculated ; six equivalents of the titanous salt are required for each nitro group.

Whilst titanous chloride solution is generally employed for nitro compounds, its use for this purpose has been criticised because in a few cases (*e.g.*, 1-nitronaphthalene and *o*-nitroanisole) a chloroamine is formed, which rearranges to the *p*-chloroamine :

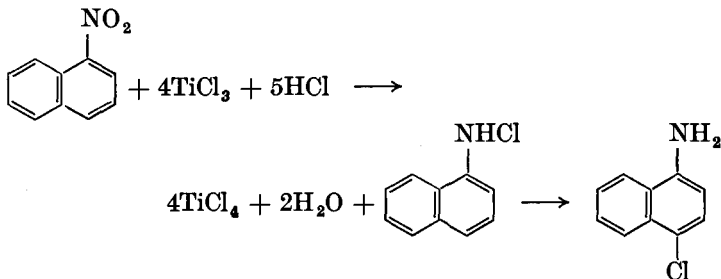

The chlorination is avoided if titanous sulphate solution is utilised, and is also reduced to negligible proportions if the solution of the nitro compound is acidified with dilute sulphuric acid when titanous chloride solution is the titrant.

When only one nitro group is present with no other activating group, *e.g.*, mononitro derivatives of benzene, toluene, xylene, chlorobenzene

and naphthalene, reduction is slow and more drastic reducing conditions are required, for example, prolonged boiling in alcoholic solution under reflux with excess of a titanous salt : the compound may also either be sulphonated with fuming sulphuric acid and then reduced, or advantage is taken of the increased reducing power of a titanous salt at low acidity by conducting the reduction at room temperature in the presence of a sodium acetate buffer. Satisfactory results are obtained under the usual experimental conditions with *m*-nitroaniline, *p*-nitroaniline, *o*-nitrophenol, *p*-nitrophenol, *m*-dinitrobenzene, 2 : 4-dinitrotoluene, trinitrobenzene, picric acid and 2 : 4-dinitrophenylhydrazine.

Nitroso compounds are reduced in the following manner :

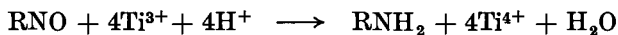

Good results are obtained, for example, with *p*-nitrosodimethylaniline.

Azo compounds are reduced in accordance with the following equation :

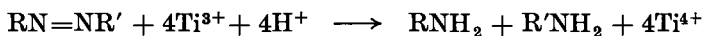

Excellent results are obtained for *p*-nitrobenzene-azo-resorcinol, methyl orange and numerous dyestuffs. Some dyestuffs, *e.g.*, phenyl-azo- $\beta$ -naphthol, require a preliminary sulphonation in the cold with fuming sulphuric acid. A hydrazo compound is formed intermediately and, for some azo compounds, the benzidine (and/or semidine or diphenylene) rearrangement may occur partially or completely in the acid medium. If the benzidine or related rearrangement is quantitative, the reaction may be written :

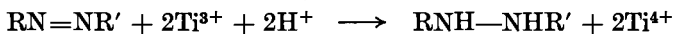

Solutions of titanous salts may be prepared from the commercially available concentrated solutions ; these include titanous chloride, technical, 15 per cent. w/v ; titanous chloride, low in iron but containing zinc chloride, 15 per cent. w/v ; and titanous sulphate, technical, 15 per cent. w/v. Decinormal solutions may be prepared by dilution with the appropriate mineral acid. The ferrous iron which is generally present in the technical product does not interfere in most of the determinations with titanous salts. However, the availability of almost pure titanium metal " sponge " renders the preparation of solutions of titanous salts, free from iron, possible : metallic titanium is dissolved in warm dilute hydrochloric acid or in warm dilute sulphuric acid.

The standardisation of titanous solutions may be effected with pure *p*-nitroaniline when they are to be used for the determination of nitro groups. A more general method is by means of A.R. ferric ammonium sulphate solution. A check on the latter

solution may be made (if desired) by determining the iron by an iodimetric method :

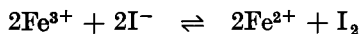

The equilibrium is displaced to the right by a large excess of iodide ion and the reaction is accelerated by the addition of a trace of cuprous iodide as catalyst. The procedure consists in treating 25.0 ml. of the ferric solution in an iodine flask with 5 ml. of 4*N* hydrochloric acid, adding 2 g. of A.R. potassium iodide and a little freshly precipitated cuprous iodide, allowing the reaction mixture to stand for 5 minutes, and titrating with standard 0.1*N* sodium thiosulphate solution to the starch end point.

Another procedure for standardising the titanous solution, prepared from metallic titanium and which is therefore free from iron, consists in direct titration at about 60°C. in a stream of carbon dioxide either with standard 0.1*N* potassium permanganate solution (the colour change is very sharp) or with standard 0.1*N* potassium dichromate solution, using *o*-phenanthroline as indicator : the oxidising agent is placed in the flask and is strongly acidified with dilute sulphuric acid. The normality thus obtained should agree with that from the standard ferric solution.\*

The reagent must be kept out of contact with air both in the storage vessel and in the burette : for this purpose, the arrangement shown in either Fig. XXVIII, 2, 1 or Fig. XXVIII, 2, 2 may be used.

## XXVIII,2. PREPARATION AND STANDARDISATION OF 0.1*N* TITANOUS CHLORIDE AND 0.1*N* TITANOUS SULPHATE SOLUTIONS

### REAGENTS

**Titanous chloride reagent, ca. 0.1*N*.** *From metallic titanium.* Place 12 g. of titanium metal "sponge" in a litre beaker or flask, add 800 ml. of dilute hydrochloric acid (1 : 1, v/v) and warm on a water bath until all (or most of) the metal dissolves (about 6 hours). Allow to cool in a stream of hydrogen. (Extinguish all flames in the vicinity.) Dilute to 2 litres with freshly boiled and cooled distilled water. Filter, if necessary.

*From commercial titanous chloride solution.* Add 200 ml. of commercial titanous chloride solution (15 per cent. w/v) to 200 ml.

\* It may be noted that a 1 per cent. solution of methylene blue may also be employed as indicator in titrating ferric iron, the disappearance of the blue colour taking place only after the whole of the ferric iron has been reduced to the ferrous condition. Since methylene blue consumes titanous solution for its decolourisation, the amount added should be only such as to tinge the solution. The end point is sharp if the ferric solution is warmed previous to titration to about 35°.

of concentrated hydrochloric acid, boil the solution for 1–2 minutes in a flask, and dilute to 2 litres with freshly boiled and cooled distilled water.

**Titanous sulphate reagent, ca. 0.1N.** *From metallic titanium.* Place 12 g. of titanium metal “sponge” in a litre beaker or flask, add 1200 ml. of dilute sulphuric acid (1 : 3, v/v) and warm on a water bath until all (or most of) the metal has dissolved (about 7 hours). Allow to cool in a stream of hydrogen. (Extinguish all flames in the vicinity.) Dilute to 2 litres with freshly boiled and cooled distilled water. Filter, if necessary.

*From commercial titanous sulphate solution.* Add 400 ml. of commercial titanous sulphate solution (15 per cent. w/v) to 500 ml. of dilute sulphuric acid (1 : 4, v/v) and boil the solution for 1–2 minutes. Cool to room temperature in a stream of carbon dioxide or hydrogen, and dilute to 2 litres with freshly boiled and cooled distilled water.

### STORAGE OF SOLUTIONS OF TITANOUS SALTS

The apparatus is illustrated in Fig. XXVIII, 2, 1. Charge the 2-litre storage bottle *A* with the titanous salt solution : the level of the liquid should be very near the neck of the bottle. Turn the burette stopcock *C* so that the liquid rises in the burette *B* to near the zero mark.

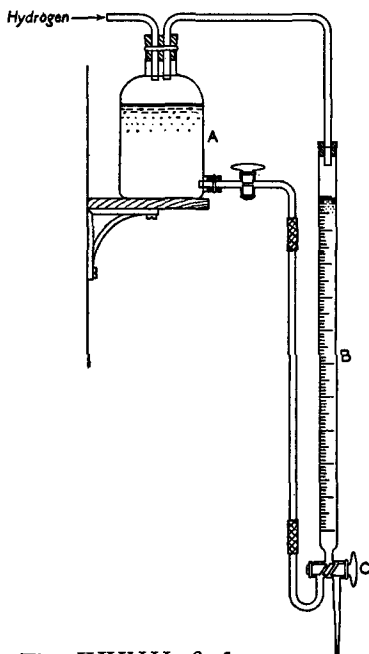

Fig. XXVIII, 2, 1.

of the liquid should be very near the neck of the bottle. Turn the burette stopcock *C* so that the liquid rises in the burette *B* to near the zero mark. Now turn the stopcock *C* so as to run out the solution already in the burette, and leave the stopcock open until all the air above the solution and in the burette has been replaced by hydrogen from the generator (e.g., a Kipp's apparatus). Allow the hydrogen to escape from the burette tip for 2–3 minutes. Fill the burette, empty it as before, and refill it again. The apparatus is now ready for use.

A layer of medicinal paraffin or of white spirit on the surface of the solution of the titanous salt is helpful in preventing oxidation.

An alternative apparatus for the storage of titanous solutions is shown in Fig. XXVIII, 2, 2.

It consists of a 500 or 1000 ml. separatory funnel *A* (supported on a rubber covered ring) and is attached to a 50 ml. burette *B*,

provided with a three-way tap *C*. The storage reservoir *A* is connected to a source of pure hydrogen and an atmosphere of this gas is maintained above the solution. The apparatus is mounted on a stand with a heavy base (not shown) and is portable. The titration vessel may consist of a three-necked flask *D*.

### STANDARDISATION OF THE TITANOUS CHLORIDE OR TITANOUS SULPHATE SOLUTION

Prepare a 0.1*N* ferric ammonium sulphate solution by dissolving 48.22 g. of the A.R. salt in 500 ml. of boiled-out distilled water to which 5 ml. of 50 per cent. (w/w) sulphuric acid has been added, and dilute to 1 litre with boiled-out distilled water.

The titration flask may consist of (i) a 250 ml. or 500 ml. three-necked flask, (ii) a 250 ml. conical flask with sealed-in side tube (Fig. XV, 5, 1), or (iii) a 250 ml. conical flask fitted with a two-holed rubber bung, through one hole of which passes a tube reaching near the bottom of the flask and the other accommodates the jet of a burette. The author prefers to use a 250 ml. or 500 ml. three-necked flask.

Place 25.0 ml. of the standard ferric ammonium sulphate solution and 25 ml. of dilute sulphuric acid (2:5, v/v) in the titration flask. Pass a rapid stream of carbon dioxide through the flask in order to displace the air. Whilst continuing to pass the carbon dioxide, run in the titanous solution until the yellow colour of the ferric solution has almost disappeared. Add 10 ml. of 10 per cent. ammonium thiocyanate solution and continue the titration until the red ferric thiocyanate colour just disappears. The reaction is somewhat slow towards the end at room temperature: for this reason the solution is often heated to the boiling point with carbon dioxide flowing, allowed to cool to about 35°, and the titration then conducted with the titanous solution as above.

Calculate the normality of the titanous solution :

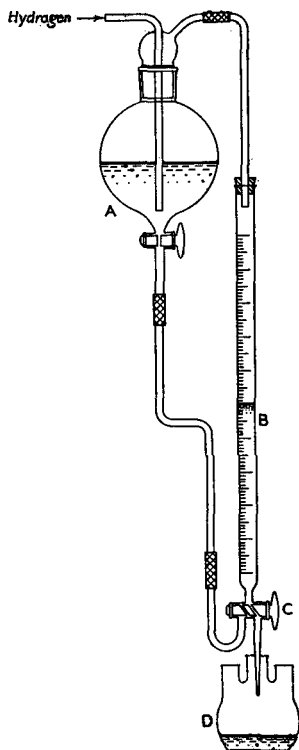
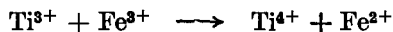

Fig. XXVIII, 2, 2.

The solution may also be standardised with standard 0.1*N* potassium dichromate solution, using sodium diphenylamine sulphonate or *o*-phenanthroline as indicator.

Many prefer to standardise the titanous solution for use in the determination of nitro groups with pure *p*-nitroaniline, m.p. 149.5°; the commercial product can be recrystallised from alcohol or water.

### XXVIII.3. DETERMINATION OF NITRO GROUPS

#### PROCEDURE

Weigh out accurately a dry sample containing about 0.015 g. of nitro group into the titration flask (1), dissolve it in water or dilute mineral acid or, if water-insoluble, in ethanol or glacial acetic acid. Add 25 ml. of dilute sulphuric acid (2 : 5, v/v). Pass carbon dioxide through the flask for 5 minutes to remove oxygen. Add 50.0 ml. of the 0.1*N* titanous sulphate solution and boil for 5–10 minutes. (Attach a reflux condenser during the boiling period for volatile samples.) (2) Maintain the current of inert gas, cool to 35–40° C., add 10 ml. of 10 per cent. ammonium thiocyanate solution, and titrate with standard 0.1*N* ferric ammonium sulphate solution to a pale red end point.

Carry out a blank or control experiment on 50.0 ml. of the titanous sulphate solution, using the same solvent for the blank as employed for the sample.

#### Notes.

(1) For experience in the titration, use *p*-nitroaniline, *m*-nitroaniline, 1 : 8-dinitronaphthalene or 2 : 4-dinitrophenylhydrazine. Weigh out accurately about 0.18 g. of *p*-nitroaniline or *m*-nitroaniline, dissolve it in 100 ml. of glacial acetic acid, and use 25 ml. per titration; weigh out accurately about 0.10 g. of 1 : 8-dinitronaphthalene, dissolve it in 100 ml. of ethanol, and use 25 ml. per titration; weigh out accurately about 0.10 g. of 2 : 4-dinitrophenylhydrazine, dissolve it in 100 ml. of glacial acetic acid, and use 25 ml. per titration. The reduction of 2 : 4-dinitrophenylhydrazine proceeds thus :

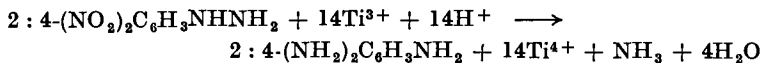

*i.e.*, the equivalent weight is molecular weight/14.

(2) Fairly accurate results may be obtained by titration at room temperature if a sodium acetate buffer is used; this procedure is applicable *inter alia* to nitrobenzene, *m*- and *p*-nitroanilines, *p*-nitrophenol, 1-nitronaphthalene, 2 : 4-dinitrotoluene, and picric acid. To an aliquot portion of the solution containing about 0.010 g. of nitro group, add 20 ml. of 20 per cent. sodium acetate solution and a measured excess of 0.1*N* titanous sulphate solution which exceeds the amount required by about 3 per cent. Swirl the solution (or otherwise stir it, *e.g.*, by a stream of

carbon dioxide) for about 15 seconds. Titrate the excess of titanous salt with 0.1N ferric ammonium sulphate solution, adding 10 ml. of 10 per cent. ammonium thiocyanate solution near the end point.

### CALCULATION

Calculate the percentage of  $\text{NO}_2$  in the sample or, alternatively, the purity of the sample.

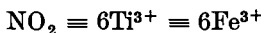

1 ML. 0.1N  $\text{Ti}^{3+}$  (as salt)  $\equiv$  1 ML. 0.1N  $\text{Fe}^{3+}$  (as salt)  $\equiv$  0.7669 mg.  $\text{NO}_2$

$$\% \text{ Purity} = \frac{(V_1 - V_2) \times N_1 \times M \times 100}{W \times 6n \times 1000}$$

where  $V_1$  = volume (ml.) of ferric ammonium sulphate solution used in the blank ;

$V_2$  = volume (ml.) of ferric ammonium sulphate solution used for sample ;

$N_1$  = normality of ferric ammonium sulphate solution ;

$M$  = molecular weight of sample ;

$W$  = weight (g.) of sample ; and

$n$  = number of nitro groups.

For 2 : 4-dinitrophenylhydrazine, the value of "6n" is 14 (see equation above).

## XXVIII.4. DETERMINATION OF NITROSO GROUPS

Practice in this determination may be obtained by evaluation of the purity of a sample of *p*-nitrosodimethylaniline. Either titanous chloride or titanous sulphate may be used.

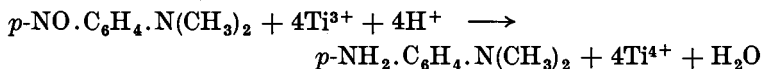

Reduction occurs quantitatively at 45–50°, and the end point is easily detected by the disappearance of the yellow colour of the solution.

### PROCEDURE

Weigh out accurately about 0.50 g. of the sample of *p*-nitrosodimethylaniline, dissolve it in dilute hydrochloric acid, and dilute to 100 ml. in a volumetric flask. Transfer 25.0 ml. of this solution to a titration flask, pass carbon dioxide into the flask for 5 minutes, warm to 40–50°C., and titrate with standard 0.1N titanous chloride or sulphate solution until the yellow colour is just completely destroyed.



## CALCULATION

Calculate the purity of the sample.



$$1 \text{ ml. } 0.1N \text{ TiCl}_3 \equiv 0.7503 \text{ mg. NO}$$

## XXVIII.5. DETERMINATION OF AZO GROUPS

Azo compounds are quantitatively reduced by titanous salts :

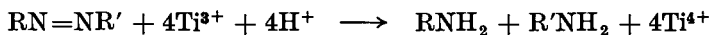

This reaction occurs provided that the intermediate hydrazo compound does not undergo a benzidine or similar transformation (see Section XXVIII,1). The azo linkage is more frequently encountered in dyes and dye intermediates. Soluble azo dyes (*e.g.*, methyl orange and orange II) may be dissolved in water, excess of the titanous solution added, the solution boiled in a stream of carbon dioxide for 3–5 minutes, and the excess of titanous salt evaluated by titration with standard 0.1*N* ferric ammonium sulphate solution, using ammonium thiocyanate solution as indicator. Highly coloured dyestuffs, such as crystal violet 6R (dyestuff from  $\alpha$ -naphthylamine and  $\beta$ -naphthol-6 : 8-disulphonic acid :  $\text{C}_{20}\text{H}_{12}\text{O}_7\text{N}_2\text{S}_2\text{Na} \cdot 7\text{H}_2\text{O}$ ), if soluble in water, may be titrated directly with the titanous solution, the dyestuff acting as its own indicator. Simple water-insoluble dyes (*e.g.*, phenylazo- $\beta$ -naphthol) may be sulphonated in the cold with fuming sulphuric acid, and the aqueous solution titrated directly with a titanous salt until decolourised. For more complex azo dyes, excess of titanous salt is added to a boiling solution of the dyestuff (dilute alcohol, alcohol, acetic acid, etc.) whilst a slow stream of carbon dioxide is passed through the flask ; the excess of titanous salt is titrated with standard ferric ammonium sulphate solution, using either the dyestuff itself or ammonium thiocyanate solution as indicator.

## PROCEDURE

Experience in the titration of azo groups may be acquired by determining the purity of a sample of methyl orange. Weigh out accurately about 0.25 g. of methyl orange\* into the titration flask, add 25 ml. of water and 25 ml. of glacial acetic acid, shake until dissolved, add 25 ml. of dilute sulphuric acid (1 : 2, v/v), pass carbon dioxide for 5 minutes to displace air, run in 50.0 ml. of 0.1*N* titanous sulphate solution, and boil for 5 minutes. Whilst

\* The sample should be dried to constant weight at 100°; the water of crystallisation (3H<sub>2</sub>O) is thus lost.

maintaining the current of nitrogen, cool, add 10 ml. of 10 per cent. ammonium thiocyanate solution, and titrate with standard 0.1*N* ferric ammonium sulphate solution.

Run a blank on 50.0 ml. of the titanous sulphate solution.

### CALCULATION

Calculate the purity of the sample of methyl orange.



$$1 \text{ ml. } 0.1N \text{ Ti}^{3+} \equiv 0.7005 \text{ mg. N}_2 \text{ (azo)}$$

$$\equiv 8.185 \text{ mg. anhydrous methyl orange}$$

$$\% \text{ Purity} = \frac{(V_1 - V_2) \times N_1 \times M \times 100}{W \times 4 \times 1000}$$

where  $V_1$  = volume (ml.) of ferric solution used in the blank ;  
 $V_2$  = volume (ml.) of ferric solution used for sample ;  
 $N_1$  = normality of ferric ammonium sulphate solution ;  
 $M$  = molecular weight of sample ; and  
 $W$  = weight (g.) of sample.

## CHAPTER XXIX

### UNSATURATION

#### XXIX.1. GENERAL DISCUSSION OF SELECTED METHODS FOR THE DETERMINATION OF UNSATURATION

The discussion will be confined to carbon-carbon or olefinic unsaturation (C=C). The procedure which has the widest application is based upon catalytic hydrogenation of the double bond :

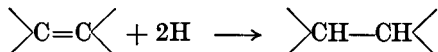

By measuring the volume of hydrogen absorbed, the number of double bonds in the compound may be calculated. Hydrogenation at atmospheric pressure may be effected either with platinum oxide catalyst (which is expensive) or with the Raney nickel catalyst. The stabilised form of the latter catalyst\* has limited application but is particularly convenient for student use ; furthermore, it is inexpensive. In the preparation of Raney nickel catalyst the nickel-aluminium alloy (50 per cent.) is treated with sodium hydroxide solution, washed thoroughly with water by decantation, and the water replaced by dry ethyl alcohol. The finely-divided nickel is pyrophoric and is stored under anhydrous ethanol : as normally used, a measured volume of the well-shaken suspension is measured out by means of a spoon or other device, For the preparation of the stabilised form of Raney nickel catalyst, the alcohol is decanted as completely as possible from the nickel, the process being assisted by centrifugation, and the residual solid mixed with molten cetyl alcohol. The resulting mixture is cast in the form of rods, which are then cut to give portions containing about 0.5 g. of Raney nickel catalyst. In this form and at temperatures in the region of 20° C., the catalyst retains its activity for many months, and is prepared for use simply by dissolving out the cetyl alcohol with ethanol.

Of the numerous procedures dependent upon bromination,

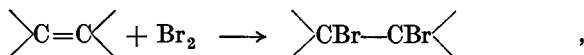

that utilising the bromine liberated by acid from a standard solution of potassium bromate and potassium bromide and conducted in the presence of mercuric sulphate as a catalyst will be described :

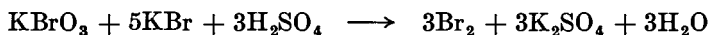

\* Supplied by British Drug Houses Ltd., Poole, Dorset, England.

This procedure gives reasonably quantitative results for a limited number of compounds, *e.g.*, cyclohexene, 1-hexene, allyl alcohol, benzalacetone, crotonic acid, cinnamic acid and maleic acid.

Most of the classical procedures for the determination of olefinic unsaturation were developed primarily for the analysis of animal and vegetable fats and oils. Unsaturation values, expressed by iodine number or bromine number (*i.e.*, values representing the amount of free halogen in grams consumed by 100 grams of the sample), obtained by the use of different halogens generally show considerable variation and often vary with the same halogen under diverse experimental conditions. They are therefore of comparatively little value for quantitative organic analysis. It is possible to obtain reproducible results by rigorous control of the reaction conditions; for commercial work and for specification purposes, reproducibility is all that is required. Some of the semi-empirical procedures employed commercially for determination of the unsaturation values of oils and fats of vegetable and animal origin will be described for the sake of completeness.

Hubl (1884) found that an alcoholic solution of iodine in the presence of mercuric chloride adds to olefinic double bonds; the active reagent is assumed to be the iodine monochloride formed thus :

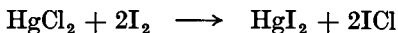

The Hubl reagent is very unstable and requires long reaction times (3-18 hours) to ensure complete addition. Hubl's method has been largely replaced by Wijs' procedure (1898) in which a solution of iodine monochloride in glacial acetic acid is used: this is much more stable than Hubl's solution and acts more rapidly. A large excess of reagent is employed and the reaction time is usually 30 minutes.

Hanus (1901) introduced a solution of iodine monobromide in acetic acid as a halogenating reagent. The Hanus solution has good keeping qualities and its mode of use is similar to that of Wijs' solution.

Rosenmund and Kuhnhehn (1923) proposed the use of pyridine sulphate dibromide ( $\text{C}_5\text{H}_5\text{N} \cdot \text{H}_2\text{SO}_4 \cdot \text{Br}_2$ ) as a reagent capable of providing a very active halogen which adds readily to olefinic double bonds and has little tendency to participate in secondary reactions of substitution or oxidation. An improved reagent utilises mercuric acetate as catalyst. The reagent, approximately 0.1*N* with respect to bromine in glacial acetic acid, has good keeping qualities.

## XXIX,2. CATALYTIC HYDROGENATION

## APPARATUS

A simple macro apparatus will first be described which will serve the dual purpose of giving the student practice in the quantitative determination of  $C=C$  unsaturation and also in isolation of the reduction

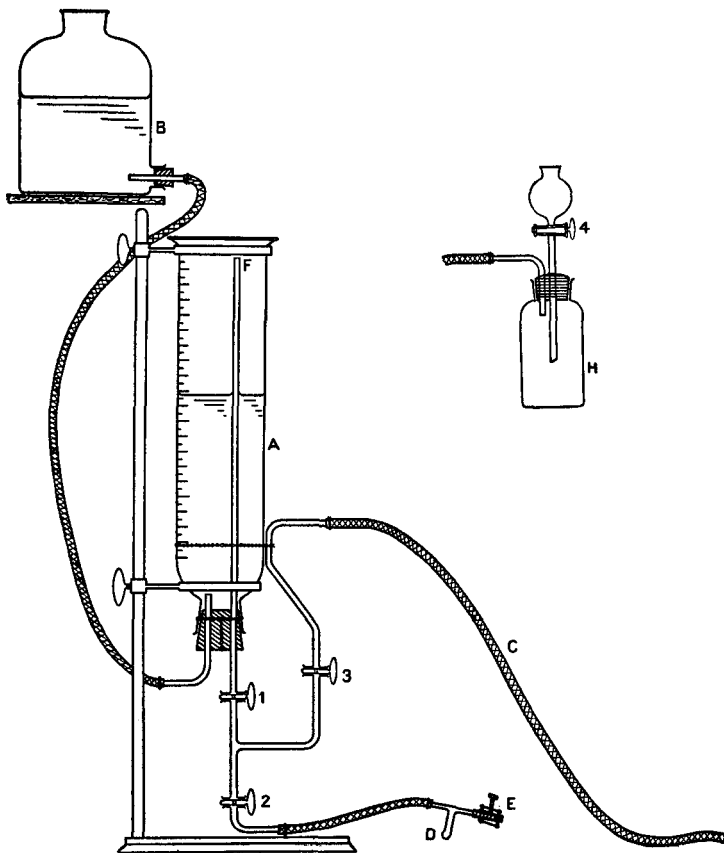

Fig. XXIX, 2, 1.

product. Either Adams' platinum oxide catalyst or stabilised Raney nickel catalyst may be used.

The apparatus is shown in Fig. XXIX, 2, 1. The bottle *B* has a capacity of 2.5 litres and *A* is a narrow-mouthed 2-litre graduated cylinder. All rubber tubing (1) is of the heavy-wall type ("pressure" tubing) and is "wired on" to the glass by means of copper wire ligatures; the rubber stoppers in *A* and *B* are likewise fixed firmly in position by copper wires. The glass tube carrying the stopcock 3 is

securely attached to the cylinder *A* in any convenient manner (copper wire, etc.). The rubber "pressure" tubing *C* is about 1 metre long. To charge the measuring cylinder with hydrogen, fill it first almost completely with water (the glass tube *F* is within 5 mm. of the top) and adjust the level of the water in the bottle *B* so that it is just above the lower tubulure. Close stopcocks *1*, *2* and *3*. By means of rubber "pressure" tubing connect a hydrogen cylinder, provided with a needle valve control, to *D*. Open the screw clip *E* and pass a *slow* stream of hydrogen through the T-piece. Open taps *1* and *2* and adjust the screw clip *E* so that hydrogen passes slowly into *A*; the displaced water enters *B*. When the level of the water in *A* is near to the 2000 ml. mark, open the screw clip *E* and simultaneously close the stopcocks *1* and *2*: shut off the hydrogen supply at the cylinder. Now open stopcocks *1* and *3* and thus refill the cylinder *A* almost completely with water; allow the hydrogen to run to waste. Repeat the process four or five times to ensure the complete elimination of any air present in *A*. Finally, charge the cylinder *A* with hydrogen; stopcocks *1*, *2* and *3* must then be kept closed.

The hydrogenation is conveniently conducted in a wide-mouthed bottle *H* of 250 ml. capacity, provided with a "head" carrying a 50 ml. funnel and fitted into the vessel by means of a ground glass joint. The funnel permits the addition of solvents or solutions and also provides an outlet for displacing the air in the bottle. Test the apparatus for leakages in the following manner. Lubricate the ground joint with a suitable inert grease (e.g., Silicone stopcockgrease) and fix the "head" tightly into the bottle by means of short lengths of rubber tubing over it and held by means of copper wire ligatures round the neck of the bottle. Clamp the

bottle in a shaking machine and attach the rubber tubing *C*; this should be loosely clamped near the centre to prevent undue strain on the glass. Open stopcocks *1*, *3* and *4* and displace the air from the bottle *H* with hydrogen. Close the stopcock *4* from time to time; this will assist the displacement of the air and will also permit the detection of a leak in the ground glass joint. Recharge the cylinder *A* with hydrogen; close stopcock *3* during this process. Open taps *1* and *3*, close tap *2*, equalise the levels in *A* and *B*, record the volume of hydrogen and return *B* to the position shown in the figure. Set the shaking machine in motion and observe the volume of hydrogen in *A* after 30–60 minutes. If the volume remains unchanged, there is no leak in the apparatus.

The hydrogenation bottle *J*, depicted in Fig. XXIX, 2, 2, may also be used. It incorporates a magnetic stirrer (2) in lieu of the shaking machine and therefore has many advantages. The length of the rubber tubing *C* may be reduced considerably when a magnetic stirrer is employed. The mode of use of *J* is similar to that described for the bottle *H*.

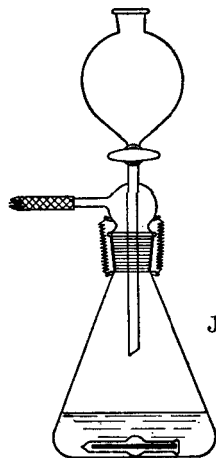

Fig. XXIX, 2, 2.

## PROCEDURE (PLATINUM CATALYST)

Place 0.1 g. of the Adams' platinum oxide catalyst (3) in the hydrogenation vessel and then introduce a solution of 5.9 g. of pure maleic acid in 75 ml. of absolute ethyl alcohol. Make sure that the catalyst is completely covered by the solution, since an explosion may occur when hydrogen is admitted if traces of the platinum oxide stick to the walls of the bottle. Lubricate the stopper with an inert grease (*e.g.*, Silicone stopcock grease or "Apiezon M") and insert it into the vessel; fix it securely in position by means of two short lengths of rubber tubing passing over the top of the stopper and held tightly against the neck of the bottle by means of copper wire ligatures. Connect the hydrogenation vessel *H* to the supply of hydrogen in the cylinder *A* by means of a length of rubber "pressure" tubing and firmly clamp the bottle in the shaking machine. Displace the air from the connecting tubes and from the bottle by closing stopcock 2, opening stopcocks 1, 3 and 4, and passing about 1500 ml. of hydrogen slowly from the reservoir; alternately close and open tap 4 from time to time in order to assist the displacement and also to detect any leaks in the ground glass joint. Finally, close taps 3 and 4, and recharge reservoir *A* so that it contains about 2 litres of hydrogen. Open taps 1 and 3. Equalise the water levels in *A* and *B*, open tap 4 momentarily and record the reading on *A*; raise *B* to its original position (as in Fig. XXIX, 2, 1). Set the shaking machine in motion; observe the temperature of the water in *B*. After 2 hours no further change in volume occurs. Equalise the levels in *A* and *B*: read the volume in *A* and also the barometric pressure.

If the hydrogenation flask shown in Fig. XXIX, 2, 2 is employed, introduce the catalyst, maleic acid and alcohol as detailed above. Lubricate the ground joint with an inert grease, insert it into the flask, and hold it in position by means of the two wire springs. Displace the air by hydrogen in a similar manner to that described for the bottle *H* (Fig. XIX, 2, 1). Agitate the liquid by means of the magnetic stirrer, and continue the stirring until no further change in volume occurs (about 2 hours). Equalise the levels in *A* and *B*: read the volume of hydrogen in *A* and also the barometric pressure.

To isolate the reduction product, filter the contents of the hydrogenation vessel through two filter papers supported on a Buchner funnel or sintered glass funnel (4), and evaporate the alcoholic solution to dryness on a water bath. The residue (5.9 g.) has m.p. 184°; the m.p. is unaffected after recrystallisation from 25 ml. of hot water or upon admixture with an authentic sample of succinic acid.

An alternative experiment consists in the reduction of cinnamic acid. Use 0.05–0.10 g. of Adams' catalyst and a solution of 5.7 g. of pure cinnamic acid in 50 ml. of absolute ethanol. The reduction is complete after 4–5 hours. Equalise the levels in *A* and *B*, and read the volume in *A*. Record the temperature of the water and the barometric pressure. Isolate the reduction product by filtering off the platinum and evaporating the filtrate on a water bath. The resulting oil solidifies on cooling to a colourless solid, m.p. 47–48° (5.6 g.). Upon recrystallisation from light petroleum, b.p. 60–80°, pure dihydrocinnamic acid, m.p. 48–49, is obtained.

#### PROCEDURE (STABILISED RANEY NICKEL CATALYST)

Place a suspension of Raney nickel, prepared from 0.5 g. of stabilised Raney nickel catalyst (5), in 10–15 ml. of absolute ethanol in the hydrogenation vessel. Introduce a solution of 5.9 g. of pure maleic acid in 75 ml. of absolute ethyl alcohol, and conduct the hydrogenation as detailed for the platinum catalyst. The reduction is complete after about 4 hours. Equalise the levels in *A* and *B*; read the volume in *A*. Note the temperature of the water and also the barometric pressure.

Filter off the finely-divided nickel and wash it with a little absolute ethanol. Keep the nickel moist with alcohol as the dry solid may be pyrophoric (6). Evaporate the alcohol in the filtrate on a water bath, and recrystallise the residue from water. The yield of succinic acid, m.p. 183–184°, is 5.6 g.

Alternatively, carry out the catalytic reduction of cinnamic acid. Use a suspension of Raney nickel in 10–15 ml. of absolute ethanol (from 0.5 g. of the stabilised catalyst) and a solution of 5.7 g. of pure cinnamic acid in 50 ml. of absolute ethyl alcohol. The reduction is complete after about 8 hours. Record the volume of hydrogen absorbed, the temperature of the water and the barometric pressure.

Isolate the reduction product by evaporation of the alcoholic filtrate, and recrystallisation of the residue from light petroleum, b.p. 60–80°. The yield of dihydrocinnamic acid, m.p. 48–49°, is 5.2 g.

#### Notes.

(1) It is recommended that all rubber parts be soaked in dilute sodium hydroxide solution, rinsed with water and finally with ethanol: catalytic poisons are thus removed. Castor oil smeared on the outside of the rubber tubing is rapidly absorbed; it has been stated that castor oil forms eventually within the walls a plastic film, which offers resistance to diffusion of gases.

(2) The stirrer consists of a metallic iron rod sealed in Pyrex glass or in Polythene; a rotating magnet (driven by an electric motor)



placed immediately below causes the stirrer to rotate inside the flask. The speed of stirring is controlled by an adjustable resistance. Many forms of magnetic stirrers are available commercially.

(3) Prepare Adams' platinum oxide catalyst as follows. Place 3.0 g. of ammonium chloroplatinate and 3.0 g. of A.R. sodium nitrate in a Pyrex beaker or porcelain casserole and heat gently at first until the rapid evolution of gas slackens, and then more strongly until a temperature of about 300° is reached. This operation occupies about 15 minutes, and there is no spattering. Maintain the fluid mass at 500–530° for 30 minutes, and allow the mixture to cool. Treat the solid mass with 50 ml. of water. The brown precipitate of platinum oxide ( $\text{PtO}_2 \cdot \text{H}_2\text{O}$ ) settles to the bottom. Wash it once or twice by decantation, filter through a hardened filter paper on a Gooch or sintered glass crucible, and wash on the filter until practically free from nitrates. Stop the washing process immediately the precipitate tends to become colloidal; traces of sodium nitrate do not affect the efficiency of the catalyst. Dry the platinum oxide in a desiccator, and weigh out portions of the dried material as required.

(4) Dry the filter paper in the steam oven, and keep the residual platinum for reconversion into the catalyst.

(5) Warm a pellet (*ca.* 0.5 g.) of the B.D.H. stabilised Raney nickel catalyst with 35 ml. of absolute ethyl alcohol to 30°, allow the resulting dark sludge to settle, and decant the alcohol. Wash the finely-divided solid with 10 ml. portions of absolute ethanol by decantation until the washings remain clear when a portion is tested with water. The catalyst is then ready for use.

(6) The Raney nickel residue may be disposed of by pouring a suspension of it in ethanol or in 2 per cent. sodium hydroxide solution into excess of dilute mineral acid.

### CALCULATION

Correct the volume of hydrogen absorbed to N.T.P., after making due allowance for the pressure of water vapour. No correction need be made for the absorption of hydrogen by the platinum oxide catalyst ( $\text{PtO}_2 \cdot \text{H}_2\text{O}$ ), since this volume is insignificant in relation to the total volume. (It is good practice, however, to compute the correction and thus fully appreciate its relative significance.)

One mol of the compound containing one double bond ( $\text{C}=\text{C}$ ) will absorb 22.415 litres of hydrogen at N.T.P.

Calculate the number of double bonds per mol from the formula :

$$\text{Double bonds per mol} = \frac{V \times M}{W \times 22415}$$

where  $V$  = volume (ml.) of hydrogen absorbed at N.T.P. ;

$M$  = molecular weight ; and

$W$  = weight (g.) of sample used.

## SEMIMICRO CATALYTIC HYDROGENATION

An apparatus suitable for the hydrogenation of small amounts (1–2 g.) of material is depicted in Fig. XXIX, 2, 3 (not drawn to scale): it is conveniently supported on a metal-rod framework\*. The main parts of the apparatus are a hydrogenation flask *A* (arranged for magnetic stirring of the contents), the two burettes *B* (500 ml.) and *C* (250 ml.) and their respective reservoirs which are filled with water, a manometer *D*, and a mercury safety trap *E*. The various parts of the apparatus are connected together largely

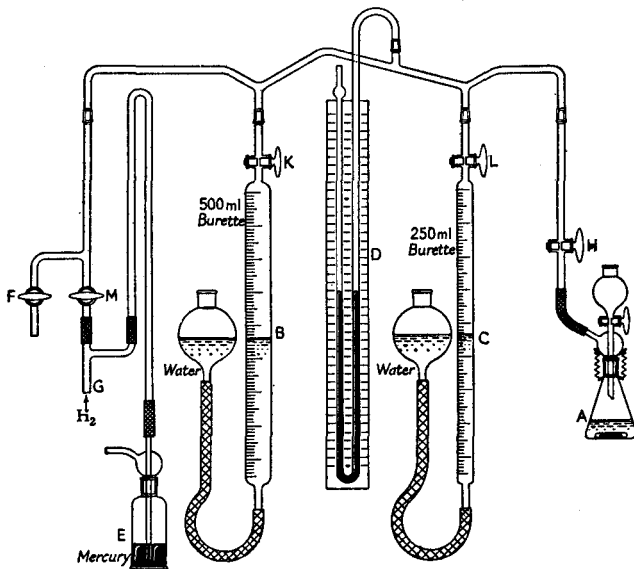

Fig. XXIX, 2, 3.

by ground glass joints; thick walled rubber "pressure" tubing is used for attaching the reservoirs, the hydrogenation flask and the trap.

First examine all the stopcocks and see that they are properly lubricated. Clean the stopcock barrel and the socket with cotton wool moistened with dry ether: apply the lubricant (Silicone stopcock grease or "Apiezon M") as a few light longitudinal streaks. Insert the barrel into its socket and turn the barrel backwards and forwards several times; the greased parts should be free from striations.

Examine all ground glass joints including that of the flask *A*, and ensure that they are properly greased. See that there is

\* Laboratory scaffolding supplied by Jencons Scientific Ltd., Hemel Hempstead, Herts; by J. W. Towers Ltd., Widnes, etc.

sufficient clean water in the reservoirs attached to the burettes *B* and *C*.

Dissolve 1.5 g. of pure maleic acid in 25 ml. of ethanol in the hydrogenation flask *A*, and add 25 mg. of Adams' platinum oxide catalyst.

Connect tap *F* to a good water pump (or other source of vacuum) via a trap and a three-way stopcock. Attach *G* by means of pressure tubing to a hydrogen cylinder fitted with a reducing valve. Follow the undermentioned procedure in the order given.

(1) Open tap *H*. Raise the reservoirs attached to the burettes and fill the burettes *B* and *C* with water to the taps *K* and *L*. Close taps *K* and *L*. Lower the reservoirs on their respective stands.

(2) Attach the hydrogenation flask *A* (with contents) to *H* by means of rubber "pressure" tubing.

(3) Open tap *H*; close taps *M*, *K* and *L*; evacuate the apparatus with a filter pump or mechanical pump via tap *F*.

(4) Close tap *F*, and fill the apparatus with hydrogen via tap *M* to atmospheric pressure as indicated by the manometer *D*. Close tap *M*.

(5) Re-evacuate the apparatus through tap *F*, and then close tap *F*.

(6) Refill the apparatus with hydrogen through tap *M*. Then open taps *K* and *L* so that the burettes fill with hydrogen. Close tap *M*.

(7) With taps *F* and *M* closed, and taps *K*, *L* and *H* open, level the water in the reservoirs against that in the burettes in order to bring the hydrogen to atmospheric pressure. Record the water levels in the burettes. Close tap *L*.

(8) Stir the contents of the hydrogenation flask *A* magnetically, and adjust the level of the reservoir attached to the burette *B* so as to maintain the hydrogen at a pressure slightly greater than atmospheric. When the hydrogen in *B* is almost used up, level off the reservoir, take the burette reading, and close tap *K*. Then open tap *L* and use the hydrogen in burette *C*.

(9) When absorption of hydrogen ceases, adjust the level of the reservoir for burette *C* and read the burette. Close tap *L* and stop the magnetic stirring.

(10) With taps *K* and *L* closed, evacuate the apparatus through tap *F*. Admit air through *F*, and detach the hydrogenation flask *A*.

Filter off the spent platinum catalyst through two filter papers supported on a small Buchner or Hirsch funnel, and wash it with a little alcohol. Place the spent catalyst with the filter paper in the PLATINUM RESIDUES bottle. Evaporate the alcoholic filtrate to dryness on a water bath. The residue (*ca.* 1.5 g.) has

m.p. 184°; the m.p. is unaffected by recrystallisation from a little hot water or upon admixture with an authentic sample of succinic acid.

Correct the volume of hydrogen absorbed to N.T.P., and calculate the number of double bonds per mol of sample as described for the macro hydrogenation.

### XXIX.3. DETERMINATION OF UNSATURATION BY MERCURY-CATALYSED BROMATE-BROMIDE TITRATION

#### REAGENTS

*Potassium bromate-potassium bromide solution, ca. 0.2N.* Dissolve 5.5 g. of A.R. potassium bromate and 20.0 g. of A.R. potassium bromide in water and dilute to 1 litre in a volumetric flask. Standardise the solution by acidifying 10.0 ml. with *ca. N* sulphuric acid (employ an iodine flask to avoid the loss of bromine vapour), adding 5 ml. of 10 per cent. potassium iodide solution, and treating the liberated iodine with standard 0.1N sodium thiosulphate solution, using 1 ml. of starch solution near the end point. This standardisation is not essential when a blank determination is made.

*Sodium thiosulphate solution, 0.1N.* Dissolve 25 g. of A.R. sodium thiosulphate crystals ( $\text{Na}_2\text{S}_2\text{O}_3 \cdot 5\text{H}_2\text{O}$ ) in a litre of boiled-out distilled water. Standardise the solution with A.R. potassium iodate.

*Starch indicator solution.* Make a slurry of 1.0 g. of soluble starch with 5-10 ml. of water and pour the suspension, with constant stirring, into 100 ml. of boiling water. Boil the mixture for 1 minute, allow to cool, and add 3 g. of potassium iodide. Transfer the solution to a stoppered bottle.

*Potassium iodide solution, 10 per cent.* Dissolve 10 g. of A.R. potassium iodide in 100 ml. of water.

*Mercuric sulphate solution, ca. 0.2N.* Dissolve 15 g. of pure mercuric sulphate in a solution prepared from 14 ml. of concentrated sulphuric acid and 475 ml. of water.

*Sulphuric acid, 10 per cent.* Add 15 ml. of concentrated sulphuric acid cautiously to 240 ml. of distilled water.

*Sodium chloride solution, ca. 2N.* Dissolve 58.5 g. of A.R. sodium chloride in 500 ml. of distilled water.

#### PROCEDURE

For water-soluble compounds, weigh sufficient of the compound into a volumetric flask to produce a solution *ca. 0.8N* in unsaturation, and use 25 ml. (about 2 milli-equivalents in unsaturation) for each titration. Alternatively, a known amount (0.1-0.2 g.) may be weighed directly into the titration flask. For hydrocarbons and water-insoluble compounds, dissolve the sample in carbon tetrachloride.

Introduce a known amount of the sample into a 250 ml. iodine flask, add a calculated excess (10–15 per cent.) of the bromate-bromide solution and about 20 ml. of 10 per cent. sulphuric acid. Shake the flask for 5 minutes : this will allow sufficient time for the bromine to be liberated. Add 10 ml. of the mercuric sulphate solution, mix thoroughly and allow to stand, with occasional shaking for 7–10 minutes. Then add 15 ml. of 2*N* sodium chloride solution,\* followed by 20 ml. of 10 per cent. potassium iodide solution. Shake the flask for about 30 seconds, and titrate the liberated iodine with standard 0.1*N* sodium thiosulphate solution : add about 0.5 ml. of starch solution near the end point.

Run a blank determination, with one half or one third of the volume of bromate-bromide solution used in the analysis, under the same experimental conditions as the sample.

Satisfactory results are obtained for 1-hexene, *cyclohexene*, allyl alcohol, benzalacetone, maleic acid, crotonic acid and cinnamic acid. No catalyst is required for either benzalacetone or cinnamic acid ; indeed, further substitution occurs in the presence of the catalyst and abnormal results are obtained. Maleic acid requires a reaction time of 30 minutes. Compounds such as phenols and amines, which are substituted by bromine, and those which are oxidised by bromine, *e.g.*, some aldehydes and hydrazones, interfere.

### CALCULATION

Calculate the purity of the sample from the formula :

$$\% \text{ Purity} = \frac{(V_1 - V_2) \times N_1 \times M \times 100}{W \times B \times 2000}$$

where  $V_1$  = volume (ml.) of thiosulphate solution consumed by blank ;

$V_2$  = volume (ml.) of thiosulphate solution consumed by sample ;

$N_1$  = normality of sodium thiosulphate solution ;

$M$  = molecular weight of sample ;

$W$  = weight (g.) of sample ; and

$B$  = number of mols of bromine absorbed by 1 mol. of the compound being determined.

If the molecular weight of the compound is not known, calculate the bromine number (weight of bromine in grams reacting with 100 grams of sample) from the relationship :

Bromine number

$$= \frac{(\text{Ml. of KBrO}_3\text{-KBr} \times \text{Normality} - \text{Ml. of Na}_2\text{S}_2\text{O}_3 \times \text{Normality}) \times 7.992}{\text{Weight of sample (g.)}}$$

\* Sodium chloride is necessary in order to liberate free bromine from its complex with mercuric sulphate.

## XXIX.4. DETERMINATION OF UNSATURATION BY THE ADDITION OF IODINE MONOCHLORIDE. WIJS' METHOD

### REAGENTS

*Wijs' solution.* This is a solution of iodine monochloride in acetic acid and can be prepared by either of the following methods.

(a) Dissolve 13.0 g. of resublimed iodine in 1 litre of A.R. glacial acetic acid, and determine the strength of the solution by titration with standard 0.1*N* sodium thiosulphate solution. Pass dry chlorine gas through the solution until the titre is doubled. With a little experience the proper termination of the chlorination is ascertained by the fairly sudden change in colour from dark brown to orange yellow, and if the gas is passed until this just occurs, the first titration may be omitted; it is better, however, to ensure (by titration) that excess of chlorine is not used, for iodine trichloride renders the solution unstable. If too much chlorine is used, a solution of iodine in glacial acetic acid should be added to compensate.

(b) Dissolve separately 7.9 g. of A.R. iodine trichloride and 8.7 g. of resublimed iodine in glacial acetic acid by warming on a water-bath. Mix the two solutions and dilute to 1 litre with glacial acetic acid.

Store the Wijs' solution in a well-stoppered, amber bottle. It keeps for about a month. The solution possesses a high coefficient of expansion, 1° C. making a difference corresponding to 0.06 ml. of 0.1*N* thiosulphate on a 25 ml. portion.

*Potassium iodide solution, 15 per cent.* Dissolve 15 g. of A.R. potassium iodide in 100 ml. of water.

*Sodium thiosulphate solution, 0.1*N*.* See Section XXIX.3.

*Starch indicator solution.* See Section XXIX.3.

### PROCEDURE

Place a quantity of the sample (1), such that 70 to 90 per cent. of the reagent will remain unreacted after the reaction is complete, in a 500 ml. iodine flask; dissolve the sample in 20–25 ml. of chloroform or carbon tetrachloride. Add 25.0 ml. of the Wijs' reagent, stopper the flask, shake and allow to stand in the dark for 30 minutes with occasional shaking. At the end of the reaction period, add 20 ml. of the potassium iodide solution and 100 ml. of water. Run in standard 0.1*N* sodium thiosulphate solution at once from a burette, with constant vigorous shaking to ensure the extraction of all the iodine from the organic layer, until the liquid becomes yellow. Add starch solution and complete the titration in the usual manner.

Perform a blank determination on 25.0 ml. of the iodine monochloride solution.

**Note.**

(1) Use 0.15 g. of the sample for iodine numbers between 150 and 200; 0.2 g. — 100 and 150; 0.3 g. — 50 and 100; 0.6 g. — 30 and 50; 1.0 g. — 0 and 30.

**CALCULATION**

Calculate the iodine number (or iodine value) from the formula :

$$\text{Iodine number} = \frac{(V_1 - V_2) \times N_1 \times 126.9 \times 100}{W \times 1000}$$

where  $V_1$  = volume (ml.) of thiosulphate solution used for blank ;  
 $V_2$  = volume (ml.) of thiosulphate solution used for sample ;  
 $N_1$  = normality of sodium thiosulphate solution ; and  
 $W$  = weight (g.) of sample.

**XXIX.5. DETERMINATION OF UNSATURATION  
 BY THE ADDITION OF IODINE  
 MONOBROMIDE. HANUS' METHOD**

**REAGENT**

*Hanus' iodine monobromide solution.* Prepare the reagent by either of the following methods.

(a) Dissolve 13.6 g. of A.R. iodine in 825 ml. of glacial acetic acid by warming and stirring. Titrate 25.0 ml. of the cold solution, diluted to 200 ml. with water, with standard 0.1*N* sodium thiosulphate solution to the starch end point.

Add 3.0 ml. of A.R. bromine from a burette to 200 ml. of glacial acetic acid, and mix well. Remove 10.0 ml., dilute to about 150 ml. with water, and add 20 ml. of 15 per cent. potassium iodide solution. Titrate the liberated iodine with 0.1*N* sodium thiosulphate. The titration of 10.0 ml. of the bromine solution should be about 80 per cent. of the titration of the iodine solution. Calculate the volume of bromine solution to be added to the remaining 800 ml. of iodine solution from the formula

$$\frac{800 \times \text{Titration of iodine solution} \times 10}{\text{Titration of bromine solution} \times 25}$$

Mix the solutions, dilute to 1 litre with glacial acetic acid, and store in a glass-stoppered, amber bottle.

(b) Dissolve 20 g. of iodine monobromide in 1 litre of glacial acetic acid.

**PROCEDURE**

Follow the experimental details given in Section XXIX,4 under Wijs' solution. The volume of the Hanus' solution should be such that at least 60 per cent. excess is used, *i.e.*, the titration of the sample should be at least 60 per cent. of the blank. Some prefer to allow the reactants to stand for 40 minutes in the dark.

Calculate the iodine number as in the previous Section.

**XXIX,6. DETERMINATION OF  
UNSATURATION WITH PYRIDINE SULPHATE  
DIBROMIDE AND MERCURIC ACETATE CATALYST**

**REAGENTS**

*Pyridine sulphate dibromide solution.* Into each of three dry 500 ml. conical flasks, place 40 ml. of glacial acetic acid. To the first add slowly 16.0 g. (16.3 ml.) of pure pyridine with cooling. In the same manner add 20.0 g. (10.9 ml.) of concentrated sulphuric acid to the second flask. When cool, combine these solutions, with further cooling, by adding the sulphuric - acetic acid mixture to the pyridine solution. To the third flask, introduce carefully 16.0 g. (5.0 ml.) of A.R. bromine and dissolve it in 40 ml. of glacial acetic acid. Finally, add the contents of the third flask to the mixture of the first two solutions, and transfer to a 1-litre volumetric flask. Make up to the mark with glacial acetic acid, and mix thoroughly. The solution is approximately 0.1N with respect to bromine, and should be kept in a dark brown or black-painted glass-stoppered bottle.

*Mercuric acetate in glacial acetic acid.* Dissolve 12.5 g. of pure mercuric acetate in 500 ml. of glacial acetic acid.

*Potassium iodide solution, 15 per cent.* See Section XXIX,4.

*Sodium thiosulphate solution, 0.1N.* See Section XXIX,3.

*Starch indicator solution.* See Section XXIX,3.

**PROCEDURE**

To an accurately weighed sample (0.2-0.5 g.), dissolved in 25 ml. of glacial acetic acid or carbon tetrachloride in a 500 ml. iodine flask, add 50.0 ml. of the pyridine sulphate dibromide reagent (use a pipette filling device, Fig. XV, 5, 3 or Fig. XV, 5, 4). Now add 20 ml. of the mercuric acetate catalyst. Promptly replace the stopper and mix the solutions by swirling. Seal the neck of the flask with 5 ml. of potassium iodide solution. Allow to stand in the dark for 1 hour (or other appropriate time) at a uniform temperature, together with a blank determination on 50.0 ml. of the reagent. Release the stopper carefully to permit the potassium iodide solution to flow into the flask so that no bromine is lost. Add a further 15 ml. of the potassium iodide solution, shake well, and allow to stand for 1 minute. Then add 100 ml. of water, washing down the stopper, neck and sides of the flask. Mix the contents thoroughly, and titrate the liberated iodine with standard 0.1N sodium thiosulphate solution, adding a little starch indicator solution when the titrated solution has acquired a yellow colour. The end point should persist for 2 minutes.

When carbon tetrachloride is used as the solvent for the sample, it will tend to depress the solubility of the mercuric acetate in acetic acid slightly and may lead to the separation of a crystalline precipitate



of the catalyst after the solution has stood for some time. This phenomenon apparently has no adverse effect on the results.

### CALCULATION

Calculate the **bromine number** (or bromine value) of the sample from the formula :

$$\text{Bromine number} = \frac{(V_1 - V_2) \times N_1 \times 79.92 \times 100}{W \times 1000}$$

(see Section XXIX,4 for significance of symbols).

## CHAPTER XXX

### ALKOXYL GROUPS

#### XXX.1. SEMIMICRO DETERMINATION OF METHOXYL GROUPS

##### THEORY

The determination is based upon a procedure first suggested by S. Zeisel in 1885. A known weight of the compound is decomposed by heating with constant boiling hydriodic acid whereby it is decomposed yielding the volatile methyl iodide :

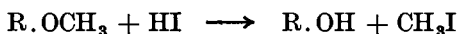

The methyl iodide is removed from the boiling reaction mixture in a slow stream of carbon dioxide, washed free from any hydrogen iodide, iodine and hydrogen sulphide, and then absorbed in a 4 per cent. alcoholic solution of silver nitrate. A double salt, silver iodide-silver nitrate, is precipitated ; this is filtered off, decomposed by dilute nitric acid into silver nitrate, which passes into solution, and insoluble silver iodide, which is removed and weighed.

In practice, it is more convenient to use a volumetric procedure to determine the methyl iodide formed in the reaction. The alkyl iodide is absorbed in an acetic acid solution of sodium acetate containing bromine ; under these conditions, iodine monobromide is first formed, which is further oxidised to iodic acid :

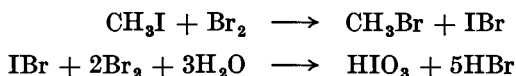

The iodic acid is determined by diluting with water, adding concentrated sodium acetate solution\*, and destroying the excess of bromine with formic acid :

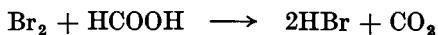

The liquid is then acidified with sulphuric acid, potassium iodide solution is added, and the liberated iodine is titrated with standard sodium thiosulphate solution :

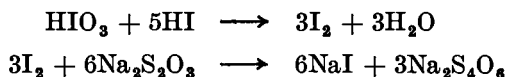

\* Unless more sodium acetate solution is introduced (to buffer fully the hydrobromic acid formed in the reaction), the addition of formic acid fails to destroy the colour (bromine) in the solution.

It is clear that a very favourable conversion factor results, since six times the original quantity of iodine is ultimately liberated :



or

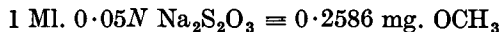

### APPARATUS

The apparatus (Fig. XXX, 1, 1—not drawn to scale) consists of a Pyrex two-necked, round-bottomed 100 ml. flask *AB* fitted with two standard ground glass joints (B19 at *A* ; B14 at *B*).

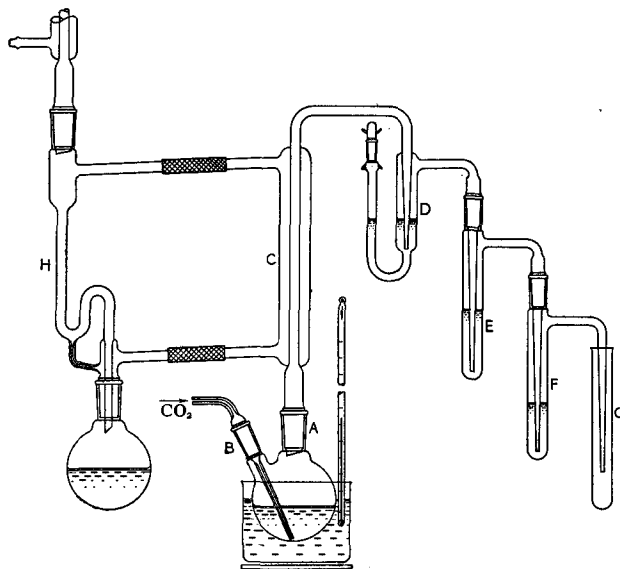

Fig. XXX, 1, 1.

A Liebig condenser *C* (14–15 cm. jacket) and trap *D* is attached at *A*. The trap *D* is connected to two test-tube receivers *E* and *F* (25 ml. capacity) by means of ground glass joints (B14) ; *G* is merely a safety tube, which serves to collect any liquid should the passage of gas through the apparatus accidentally become unduly fast. The capillary tubing (1 mm. bore) passing through the ground joint at *B* is connected to a source of carbon dioxide, *e.g.*, a Kipp's apparatus via a small "bubbler" containing water. *H* is a device by means of which the vapour of the liquid (chloroform, b.p. 62°) boiling in the flask can be passed through the condenser *C* ; it requires no attention once the liquid is boiling at a steady rate. The reaction flask is immersed in an oil bath ; the latter carries a thermometer, and is heated by a semimicro burner protected from draughts.

## REAGENTS

*Acetic acid, sodium acetate, bromine solution.* Dissolve 10 g. of A.R. anhydrous sodium acetate in 100 ml. of glacial acetic acid. Add 0.3 ml. of glacial acetic acid. Add 0.3 ml. of A.R. bromine per 10 ml. of solution immediately before use.

*Antimonyl sodium tartrate solution.* A 8–10 per cent. solution in water.

*Sodium acetate solution.* A 25 per cent. solution in water.

*Sulphuric acid solution.* A 10 per cent. (v/v) solution.

*Standard sodium thiosulphate solution, 0.05N.* See Section XXIX,3; standardise with A.R. potassium iodate.

*Starch indicator solution.* A 1 per cent. solution; see Section XXIX,3.

## PROCEDURE

Clean the apparatus with chromic-sulphuric acid mixture, rinse well with tap water, then with distilled water, and finally dry in an air oven at 120° C. Assemble the apparatus as in Fig. XXX, 1, 1. Lubricate all ground glass joints lightly with Silicone stopcock grease. Charge the trap *D* with sufficient antimonyl sodium tartrate solution (1) to just cover the internal tube; this reagent will effectively absorb hydriodic acid, iodine and hydrogen sulphide, but will not retain the alkyl iodide. Place 10–12 ml. of the acetic acid-sodium acetate-bromine solution in *E* and an equal volume in *F*.

Weigh out accurately about 25 mg. of the solid sample (*e.g.*, vanillin or  $\alpha$ -methyl-D-glucoside) (2) into a small tinfoil cup; the cup may be made by cutting off the corners of a small square of thin tin foil, and then pressing this rough circle into a cup round the end of a glass rod. After weighing, lightly close the cup by pinching the edges together, and then introduce it carefully into the reaction flask through *B*: disconnect the flask for this purpose. Add about 0.5 g. of A.R. phenol, 1.0 ml. of redistilled propionic anhydride, and a few small carborundum chips (3). Warm the reaction mixture gently to dissolve the sample; it is important that the sample is completely dissolved before adding the hydriodic acid. Attach the flask to the condenser *C*. Introduce 10 ml. of A.R. hydriodic acid (4) through the neck *B*, insert the capillary tube and connect to the source of carbon dioxide. Pass chloroform vapour through the jacket of the Liebig condenser *C* for 10 minutes, and heat the oil bath gradually. Adjust the rate of passage of the carbon dioxide through the apparatus so that the rate of bubbling in the receivers *E* and *F* is under control (one or two bubbles per second). The temperature of the oil bath should reach 145° in about 75 minutes. The reaction is then complete. Transfer the contents of the receivers *E* and *F* quantitatively to a 250 ml. flask fitted with a ground glass stopper (an iodine flask

is satisfactory) and containing 10 ml. of 25 per cent. sodium acetate solution. Add A.R. formic acid (*ca.* 90 per cent.) drop by drop to the solution in the titration flask until the smell of bromine can no longer be detected. Insert the stopper, shake the flask well and cool it slightly; carefully remove the stopper and wash it, allowing the washings to enter the flask. Then add a small drop of methyl red indicator solution; if the indicator is decolourised (thus pointing to the presence of bromine), add a further drop or two of formic acid. Dilute the solution to about 100 ml., add 1 g. of A.R. potassium iodide and 10 ml. of 10 per cent. sulphuric acid. Stopper the flask, swirl the contents gently, and allow to stand stoppered for 3-5 minutes. Titrate the liberated iodine with standard 0.05*N* sodium thiosulphate solution, using starch as indicator.

A blank determination may be run on the phenol and propionic anhydride alone; in most cases the blank is so small as to be unnecessary.

#### Notes.

(1) The following reagents have been used in the washer (scrubber):

(a) A suspension of purified red phosphorus in water (this removes hydrogen iodide and iodine).

(b) Five per cent. aqueous cadmium sulphate solution (this removes any hydrogen sulphide formed by the reducing action of the hydriodic acid upon samples containing sulphur).

(c) A suspension of purified red phosphorus in 5 per cent. cadmium sulphate solution.

Experience indicates that antimonyl sodium tartrate solution is the most satisfactory for semimicro determinations.

(2) If it is desired to gain experience in the use of a liquid, either anisole ( $C_6H_5OCH_3$ ; b.p. 154°) or veratrole ( $C_6H_4(OCH_3)_2$ ; b.p. 206°) may be used. The liquids are weighed directly into the flask with the aid of a weighing bottle fitted with a dropper (Fig. XIV, 1, 5).

(3) Some compounds do not dissolve in hydriodic acid. Most alkoxy compounds are dissolved by a mixture of phenol and propionic anhydride.

The reaction mixture does not bump in the presence of stannous iodide formed in the subsequent reaction. The addition of carborundum fragments provides an additional safeguard to ensure smooth boiling.

(4) The constant boiling acid (b.p. 126°/760 mm.) containing 57 per cent. of HI is satisfactory. Many chemists prefer to distil the commercial product in an all-glass apparatus in a stream of carbon dioxide or nitrogen, and to collect the middle fraction of constant boiling point; this is not usually necessary for the A.R. acid. The acid should be stored in a brown glass bottle; if it is a dark colour (due to the presence of free iodine), this is not harmful and, indeed, it is said to be advantageous since combined sulphur is converted into the elementary form and its interference is prevented.

**Hydriodic acid**, suitable for methoxyl determinations, may be prepared by the reduction of iodine with hypophosphorous acid and scrubbing of the resulting constant boiling acid with carbon dioxide. Place 127 g. of resublimed iodine and 93 ml. of water in a 250 ml. flask fitted with a condenser by means of a ground glass joint. Add 33 g. of 50 per cent.

sulphate-free hypophosphorous acid ( $\text{H}_3\text{PO}_2$ ) in small portions at such a rate that the mixture boils continuously: all the iodine should ultimately be reduced. Boil for a further 3 hours, during which time a stream of carbon dioxide is passed through the solution. Now distil the solution (whilst maintaining the passage of carbon dioxide) and collect the constant-boiling hydriodic acid at  $126\text{--}127^\circ$ : discard the first 5–7 ml. and the last 5 ml. of the distillate. The yield is about 220 g. Store the acid in dark, glass-stoppered bottles, and add 0.5 ml. of 50 per cent. hypophosphorous acid as a preservative.

### CALCULATION

Calculate the percentage of methoxyl in the sample from the following formula:

$$\% \text{ Methoxyl} = \frac{V \times 0.2586 \times 100}{W}$$

where  $V$  = volume (ml.) of 0.05*N* sodium thiosulphate solution used in the determination; and  
 $W$  = weight (mg.) of the sample.

## XXX.2. SEMIMICRO DETERMINATION OF ETHOXYL GROUPS

### THEORY

The theory underlying the determination of ethoxyl groups is similar to that described for methoxyl groups:

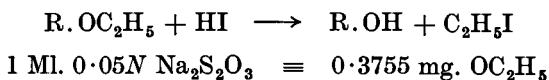

### PROCEDURE

The experimental procedure is identical with that given in the previous Section for methoxyl groups, except that trichloroethylene vapour (b.p.  $86^\circ$ ) is passed through the condenser; this is necessary because of the higher boiling point of ethyl iodide (b.p.  $73^\circ$ ).

Weigh out accurately about 25 mg. of phenacetin  
 ( $p\text{-C}_2\text{H}_5\text{O.C}_6\text{H}_4\text{.NHCOCH}_3$ )  
 and proceed exactly as detailed in Section XXX.1.

### CALCULATION

Calculate the percentage of ethoxyl in the sample from the formula:

$$\% \text{ Ethoxyl} = \frac{V \times 0.3755 \times 100}{W}$$

where  $V$  = volume (ml.) of 0.05*N* sodium thiosulphate solution used in the determination; and  
 $W$  = weight (mg.) of the sample.

The following general formula may also be used :

$$\% \text{ Alkoxy} = \frac{V_1 \times N_1 \times M \times 100}{W \times 6 \times 1000}$$

where  $V_1$  = volume (ml.) of thiosulphate solution used in the analysis ;

$N_1$  = normality of sodium thiosulphate solution ;

$M$  = molecular weight of alkoxy group ; and

$W$  = weight (g.) of the sample.

Alternative determinations may be made with *p*-ethoxydiphenyl, m.p. 72°, with *p*-ethoxybenzoic acid, m.p. 198°, or with phenetole,  $C_6H_5 \cdot OC_2H_5$ , b.p. 170°.

## CHAPTER XXXI

### C-METHYL, O-ACETYL AND N-ACETYL GROUPS

#### XXXI,1. SEMIMICRO DETERMINATION OF C-METHYL, O-ACETYL AND N-ACETYL GROUPS. THEORETICAL DISCUSSION

The three groups are considered together because one simple apparatus may be used in determining them; the apparatus is described fully in Section XXXI,2.

The C-methyl determination is based upon the oxidation of the compound with a sulphuric acid-chromic acid mixture, the resulting acetic acid is separated by steam distillation and titrated with standard baryta solution :

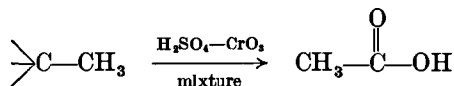

Alternatively, the acetic acid may be determined by an iodometric method. The acid is collected in standard 0.01*N* or 0.02*N* iodine solution containing excess of potassium iodide : any sulphur dioxide which may be evolved reacts with the iodine, and is evaluated by titrating the excess of iodine with standard 0.01*N* or 0.02*N* sodium thiosulphate solution. Some potassium iodate solution is added, and the acetic acid is determined by another titration with the standard sodium thiosulphate solution. Experimental details for the alkalimetric method only will be given.

Results obtained by the chromic acid oxidation procedure must be interpreted with caution. Straight-chain compounds usually give theoretical yields of acetic acid, as do also compounds in which the methyl group is in an alicyclic ring. The methyl attached to an aromatic ring and the methyl of *gem*-dimethyl and *tert*-butyl groups are not quantitatively eliminated as acetic acid. Thus the percentages of C-methyl found for a number of "anomalous" compounds are : acetophenone, 10 per cent. ; *m*-xylene, 24 per cent. ; *p*-toluidine, 60 per cent. ; *N*-ethylaniline, 90 per cent ; methylcyclohexene, 53 per cent. ; and 2 : 5-dimethylfuran, 85 per cent.

O-Acetyl compounds may be analysed by hydrolysis with *N* ethanolic potassium hydroxide solution,\* dilution of the reaction mixture with magnesium sulphate solution containing sulphuric acid, followed by distillation and titration of the liberated acetic acid. Acid hydrolysis (*e.g.*, with sulphuric acid (1 : 2, v/v)

\* *N* Methanolic sodium hydroxide solution usually gives satisfactory results also.



or with a 25 per cent. aqueous solution of toluene-*p*-sulphonic acid) is usually preferred for *N*-acetyl compounds; satisfactory results are, however, obtained with a *N* solution of potassium hydroxide in *n*-butanol (hydrolysis period, 1 hour), and occasionally (*e.g.*, for acetanilide) with ethanolic potassium hydroxide.

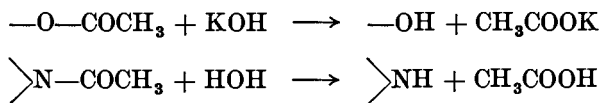

## XXXI,2. SEMIMICRO DETERMINATION OF C-METHYL GROUPS

### REAGENTS

*Sulphuric acid-chromic acid mixture (oxidising mixture).* Dissolve 16.8 g. of A.R. chromic anhydride in 100 ml. of water, and add cautiously 20 ml. of concentrated sulphuric acid. Cool.

*Barium hydroxide solution, 0.05N.* Dissolve 8.0 g. of A.R. crystallised barium hydroxide ( $\text{Ba}(\text{OH})_2 \cdot 8\text{H}_2\text{O}$ ) in distilled water and dilute with boiled-out distilled water to 1 litre. Protect the baryta solution against the entry of carbon dioxide by a guard tube containing soda lime (compare Section XXII,2). Standardise with A.R. potassium hydrogen phthalate or with a standard acid solution.

*Phenolphthalein indicator.* Dissolve 0.1 g. of phenolphthalein in 50 ml. of ethyl alcohol, and then dilute with an equal volume of water.

### APPARATUS

The apparatus is shown in Fig. XXXI, 2, 1. It consists of a 50 ml. Pyrex flask *A* to which a Liebig condenser *B* is sealed;

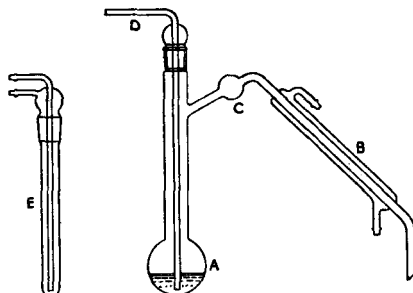

Fig. XXXI, 2, 1.

the connecting tube has a bulb *C* blown in the centre. The neck of the flask is fitted with a B19 ground glass joint, and can accommodate either the lead-in tube *D* or the finger-condenser *E*.

### PROCEDURE

Clean the apparatus by filling it with (or immersing it in) sodium dichromate - sulphuric acid cleaning mixture, allowing to stand several hours, rinsing thoroughly with tap water, and finally with distilled water. Dry it in an oven at 120° C.

Weigh out accurately, by difference, about 25 mg. of the sample (*e.g.*, anhydrous sodium acetate or crotonic acid) from a weighing bottle into the flask *A* ; introduce 2 or 3 small grains of carborundum and 5.0 ml. of the cold oxidising mixture. Insert the reflux condenser *E* into the neck of the flask and reflux the mixture for 90 minutes ; surround the flask with a small air bath and heat with a semimicro burner. Allow to cool, remove the condenser *E*, wash it with a little water and collect the washings in the flask. Add 7 g. of A.R. crystallised magnesium sulphate to the oxidation mixture, insert the tube *D*, and set up the apparatus for steam distillation. Steam distil (1) the mixture until 50 ml. of distillate are collected in a measuring cylinder (not shown in the Figure). Heat the flask by means of a small flame during the distillation to prevent the volume of liquid in the flask from becoming too large : remove the flame temporarily if the mixture tends to become viscous. Titrate the distillate with standard 0.05*N* barium hydroxide solution to a phenolphthalein end point ; use a semimicro burette. An additional 5 ml. of distillate should not change the end point appreciably.

Carry out a blank determination, omitting the sample, and apply a correction to the original titration, if necessary.

Barium hydroxide solution is most convenient for the titration because any sulphuric acid that might have been carried over is detected immediately. If sulphuric acid is found in the distillate, the determination must be repeated.

#### Note.

(1) It is essential to have complete control over the rate of passage of steam into the flask, for if the steam is inadvertently passed at too rapid a rate, some acetic acid may be lost owing to incomplete condensation and low results will be obtained. A simple apparatus consists of a distillation flask fitted with a two-holed rubber stopper in the neck : a long tube (acting as a safety tube) passes through one hole and extends almost to the bottom of the flask, whilst a short tube, terminating in a glass stopcock, passes through the other hole. By adjusting the glass stopcock, the supply of steam to the reaction flask can be controlled. The side arm of the distilling flask is connected to the apparatus.

### CALCULATION

Calculate the percentage of carbon-linked methyl in the sample from the relationship :

$$1 \text{ ml. } 0.05N \text{ Ba(OH)}_2 \equiv 0.752 \text{ mg. CH}_3$$

Alternatively, calculate the C-methyl number from the formula :

$$\text{C-Methyl number} = \frac{(V_1 - V_2) \times N_1 \times M}{W}$$

where  $V_1$  = volume (ml.) of baryta solution used in analysis ;

$V_2$  = volume (ml.) of baryta solution used in blank ;

$N_1$  = normality of barium hydroxide solution ;

$M$  = molecular weight of sample ; and

$W$  = weight (mg.) of sample.

### XXXI,3. SEMIMICRO DETERMINATION OF O-ACETYL GROUPS

#### REAGENTS

*Alcoholic potassium hydroxide solution*, ca. 1*N*. Dissolve 5.6 g. of A.R. potassium hydroxide pellets in a mixture of 50 ml. of ethyl alcohol and 50 ml. of water.

*Magnesium sulphate reagent*. Dissolve 50 g. of crystallised magnesium sulphate and 0.75 ml. of concentrated sulphuric acid in water and dilute to 90 ml.

*Barium hydroxide solution*, 0.02*N* or 0.05*N*. Prepare and standardise as in Section XXXI,2.

#### PROCEDURE

Use the apparatus illustrated in Fig. XXXI, 2, 1. Weigh out accurately about 25 mg. of the sample\* from a weighing bottle (by difference) into the flask *A*. Introduce 3.0 ml. of the *N* ethanolic potassium hydroxide solution together with 2 or 3 minute fragments of carborundum. Insert the reflux condenser *E*, and heat the liquid to boiling or until the sample has dissolved. Cool, remove the condenser *E*, wash it with a little water and collect the washings in the flask. Add 20 ml. of the magnesium sulphate reagent, and set up the apparatus for steam distillation (see *Note 1* in Section XXXI,2). Steam distil the mixture. Heat the flask with a semimicro burner in such a manner that the liquid in the flask distils at a fairly rapid rate and is concentrated to about 15 ml. during the collection of 50 ml. of distillate (use a measuring cylinder as receiver). Titrate the distillate with 0.05*N* (or 0.02*N*) baryta (contained in a semimicro burette) to a phenolphthalein end point. An additional 5 ml. of distillate should not change the end point appreciably.

Carry out a blank determination, omitting the sample, and apply a correction to the original titration, if necessary.

\* Any of the following compounds may be used to acquire experience in the determination: phenyl acetate, glucose penta-acetate, triacetin (triacetyl glycerol), acetoacetanilide, acetyl salicylic acid, and hydroquinone diacetate.

### CALCULATION

Calculate the percentage of acetyl in the sample from the relationship :

$$1 \text{ Ml. } 0.05N \text{ Ba(OH)}_2 = 2.152 \text{ mg. CH}_3\text{CO}$$

Alternatively, calculate the percentage of acetyl from the formula :

$$\% \text{ Acetyl} = \frac{(V_1 - V_2) \times N_1 \times 43.04 \times 100}{W \times 1000}$$

where  $V_1$  = volume (ml.) of baryta solution used in the analysis ;

$V_2$  = volume (ml.) of baryta solution used for blank ;

$N_1$  = normality of barium hydroxide solution ; and

$W$  = weight (g.) of sample.

### XXXI.4. SEMIMICRO DETERMINATION OF N-ACETYL GROUPS

#### PROCEDURE

Use the apparatus shown in Fig. XXXI, 2, 1.

Weigh out accurately about 40 mg. of the sample (*e.g.*, phenacetin) into the flask (*A* in Fig. XXXI, 2, 1), and add either 5–7 ml. of dilute sulphuric acid (1 : 2, v/v) or 5 ml. of a 25 per cent. aqueous solution of toluene-*p*-sulphonic acid, followed by 2 or 3 small fragments of carborundum.

Insert the reflux condenser *E* into the neck of the flask, and reflux the mixture gently for 90 minutes : surround the flask with a small air bath and heat with a semimicro burner. Allow to cool, remove the condenser *E*, wash it with a little water and collect the washings in the flask. Insert the steam distillation tube *D*, and steam distil the mixture slowly until 30–40 ml. of liquid have been collected (45–60 minutes ; use a 50 ml. measuring cylinder as receiver). Titrate the distillate with standard 0.05*N* barium hydroxide solution to a phenolphthalein end point ; use a semimicro burette (compare Fig. XXII, 2, 2 and XXII, 2, 3). An additional 5 ml. of distillate should not change the end point appreciably.

Carry out a blank determination, omitting the sample, and apply a correction if necessary.

#### CALCULATION

Calculate the percentage of acetyl in the sample from the relationship :

$$1 \text{ Ml. } 0.05N \text{ Ba(OH)}_2 = 2.152 \text{ mg. CH}_3\text{CO}$$

Alternatively, use the formula given in Section XXXI.3.

## CHAPTER XXXII

### ACTIVE HYDROGEN

#### XXXII.1. DISCUSSION OF METHODS FOR THE DETERMINATION OF ACTIVE HYDROGEN

An active hydrogen atom may be regarded as any hydrogen atom capable of interchange with a metal. Compounds containing active hydrogen atoms which can be determined by reaction with Grignard reagents (methyl magnesium iodide is generally employed because of the insolubility of methane in the solvent used) include alcohols, thiols, amines, amides, phenols, carboxylic acids, sulphonic acids, sulphonamides and acetylenes. The procedure, often known as **Zerewitinoff's method**, consists in treating the compound in an inert atmosphere with an excess of a solution of methyl magnesium iodide in an anhydrous organic solvent. The reaction is conducted in a vessel attached to a gas burette and the volume of methane liberated is measured :



*i.e.*, 1 mol of methane, or 22.415 litres at N.T.P., is evolved from each atom of active hydrogen. Thus  $R.OH \rightarrow CH_4$ ;  $RSH \rightarrow CH_4$ ;  $RNH_2 \rightarrow 2CH_4$  (usually one  $CH_4$  at room temperature, and the second  $CH_4$  on heating);  $RR'NH \rightarrow CH_4$ ;  $RCONH_2 \rightarrow 2CH_4$  (evolution of  $CH_4$  similar to  $RNH_2$ );  $RCONHR' \rightarrow CH_4$ ;  $ArOH \rightarrow CH_4$ ;  $RCOOH \rightarrow CH_4$ ;  $RSO_3H \rightarrow CH_4$ ;  $RSO_2NH_2 \rightarrow 2CH_4$ ;  $RSO_2NHR' \rightarrow CH_4$ ;  $RC\equiv CH \rightarrow CH_4$ ; and  $H_2O \rightarrow 2CH_4$ . It may be noted that the above may be regarded as an acid-base reaction :  $CH_3MgI$  is the strong base,  $R.H$  is the weak acid, and  $RMgI$  is the salt produced.

The reaction medium may be anhydrous anisole, anethole, di-*n*-amyl ether, di-*iso*-amyl ether, di-*n*-butyl ether, pyridine or xylene. Anisole is generally used because of the ease of purification and its low vapour pressure. In some cases a temperature of 90° may be required for the completion of the reaction. The Grignard reagent may decompose above 90° and hence this temperature should not be exceeded. The reaction with anisole at elevated temperatures has been given as :

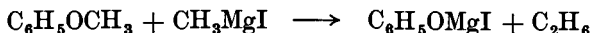

For relatively non-volatile compounds which are soluble in ether and which possess functional groups reacting completely at room temperature, the reaction with methyl magnesium iodide in ethereal solution may be employed. The only special apparatus

required is a simple nitrometer. Satisfactory results have been obtained with *cyclohexanol*, benzyl alcohol, phenol, quinol, acetic acid, benzoic acid and salicylic acid.

The Grignard reagent may be replaced by lithium aluminium hydride ; it reacts with the evolution of hydrogen :



Solvents for the lithium aluminium hydride are anhydrous diethyl ether, di-*n*-butyl ether, dioxan, tetrahydrofuran, and *N*-ethyl-morpholine. The numerical results are generally similar to those obtained with methyl magnesium iodide ; there are a few exceptions, *e.g.*, primary amines and primary amides (where both active hydrogen atoms usually react at the laboratory temperature) and keto-enol tautomers. The determination can be performed with the simple Zerewitinoff apparatus (Fig. XXXII, 2, 3).

Potentiometric titration may also be employed in tetrahydrofuran as solvent and a solution of lithium aluminium hydride in the same solvent as titrant. The indicator electrodes may be of silver or platinum, and the reference electrode may be silver - silver halide with a tetrahydrofuran solution of lithium bromide as the electrolyte for the half cell. When such electrodes are placed in a solution containing traces of lithium aluminium hydride, they undergo an abrupt change in potential of the order of 450 millivolts when the hydride is destroyed by the addition of alcohols, phenols, etc. In practice it is more convenient to add excess of the hydride reagent to the reaction mixture and to titrate the excess with a standard solution of *n*-butanol in xylene. Visual indicators, such as *N*-phenyl-*p*-aminoazobenzene and *N*-ethyl-*p*-aminoazobenzene, may also be used. No experimental details are given for the various titrimetric methods because of limitations of space.

## XXXII.2. DETERMINATION OF ACTIVE HYDROGEN WITH METHYL MAGNESIUM IODIDE IN ANISOLE OR IN AMYL ETHER

Dry all the apparatus in a steam oven or at 110–120° ; this includes the apparatus for the preparation of the Grignard reagent, the stock bottle and the two-limbed reaction vessel.

### PREPARATION OF THE GRIGNARD REAGENT (IN ANISOLE)

Assemble the apparatus shown in Fig. XXXII, 2, 1. This consists essentially of a 250 ml. Pyrex, round-bottomed flask, a 50 or 100 ml. dropping funnel and an efficient double surface condenser ; all the parts are connected by interchangeable ground

glass joints. It is recommended that all the air be displaced by dry, pure nitrogen. Place 2.4 g. of magnesium turnings

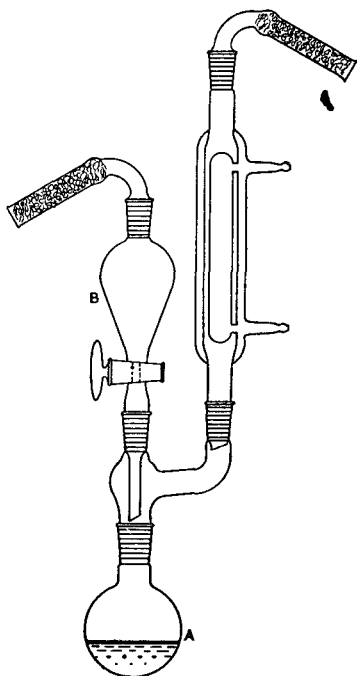

Fig. XXXII, 2, 1.

minutes. Cool the solution of methyl magnesium iodide, and decant it through a funnel containing a loose glass-wool plug into a stock bottle through which a current of nitrogen is passing. Close the bottle with a rubber bung.

(for Grignard reaction; previously dried for 20 minutes at  $100^{\circ}$ ) in the flask *A*, and a solution of 15 g. (9.8 ml.) of pure methyl iodide in 60 ml. of anisole (1) in the small separatory funnel *B*. Run in about 15 ml. of the methyl iodide solution, and initiate the reaction by rubbing the magnesium turnings against the bottom of the flask with a glass rod (*CAUTION!*); if the reaction does not start after a few minutes, introduce a small crystal of iodine into the flask and warm gently on a water bath until the reaction commences. Add the remainder of the methyl iodide solution during 30–35 minutes, and then heat on a boiling water bath for 1 hour.

Rearrange the apparatus for distillation as in Fig. XXXII, 2, 2. Distil off any unreacted methyl iodide in a stream of pure, dry nitrogen (2) by heating the flask on a boiling water bath for 15–20

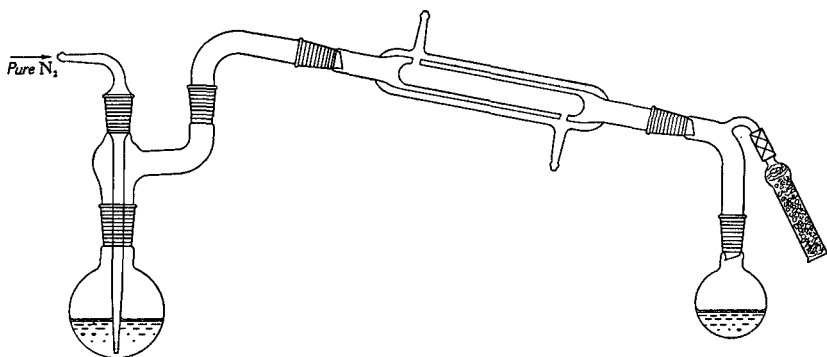

Fig. XXXII, 2, 2.

## Notes.

(1) Redistil commercial anisole from sodium and collect the fraction of b.p. 152–154°. Alternatively, either di-*n*-amyl ether or di-*iso*-amyl ether may be used; they should be repeatedly distilled from sodium until the latter is no longer attacked. Care should be taken that the aliphatic ethers are free from peroxides.

(2) Commercial (cylinder) nitrogen may be purified and subsequently dried by passage through two wash bottles containing Fieser's solution (to remove oxygen), one bottle containing concentrated sulphuric acid, and a U-tube charged with anhydrous calcium chloride. It is desirable to have a mercury safety trap incorporated in the purification train.

Fieser's solution is an alkaline solution of sodium "hydrosulphite" (dithionite;  $\text{Na}_2\text{S}_2\text{O}_4$ ) to which sodium anthraquinone- $\beta$ -sulphonate is added as a catalyst; the quinone is reduced to the hydroquinone, which absorbs oxygen readily and which is maintained in the reduced state by the dithionite present. It is prepared by dissolving 20 g. of potassium hydroxide in 100 ml. of water, and adding 16 g. of sodium "hydrosulphite" and 2 g. of sodium anthraquinone- $\beta$ -sulphonate to the warm solution: the mixture is stirred until a clear, blood-red solution is obtained. It is cooled to room temperature and is ready for use. The wash bottles do not require refilling as long as the solution remains clear and bright. When the colour changes to dull red or brown, or when a precipitate appears the solution should be replaced. With pure commercial sodium "hydrosulphite", the efficient capacity of the above volume of solution is 788 ml. of oxygen.

Nitrogen of 99.9+ per cent. purity is available commercially and may be used directly.

## PROCEDURE

Fit up the apparatus depicted in Fig. XXXII, 2, 3, and clamp it in suitable retort stands (not shown in the Figure). It is recommended that the 50 ml. calibrated nitrometer tube be placed inside an air jacket in order to exclude draughts; a thermometer can be suspended inside the jacket. The apparatus must be thoroughly dry: the di-*n*-butyl phthalate (used for filling the gas burette and the associated reservoir) should be dried with anhydrous magnesium sulphate or, better, with anhydrous calcium sulphate before use. Connexions must be made with heavy-wall rubber ("pressure") tubing and wired on to the glass. The burette stopcock and the ground glass joint of the reaction vessel should be lightly lubricated (*e.g.*, with Silicone stopcock grease).

Weigh out accurately into a small boat, a small sample tube or small ampoule about 0.1–0.5 milli-mol of the dry sample (say, about 0.03 g. of benzoic acid, salicylic acid,  $\beta$ -naphthol, resorcinol, *p*-nitrophenol, *p*-bromoaniline, *n*-hexyl alcohol or salicylaldehyde); the compound must be soluble in anisole (or in amyl ether, if the latter is used as the reaction medium). Transfer the boat, sample tube or ampoule with contents into one limb of the reaction vessel *A*, and introduce (by means of a pipette or dropper pipette) 4.0 ml. of dry anisole; dissolve the compound in the anisole—



gentle warming or shaking may be necessary. Displace the air in the reaction vessel *A* by nitrogen, and pipette 10.0 ml. of the methyl magnesium iodide reagent into the second limb; fill the pipette with the aid of a rubber bulb (or equivalent device) attached at the upper end (compare Figs. XV, 5, 3 and XV, 5, 4). Insert the top part of the reaction vessel, check that the ground joint is adequately lubricated, and fit the wire springs into position. Attach the reaction vessel to the 50 ml. graduated burette *B* by a short length of rubber "pressure" tubing, and remove the plug (key) of the tap *C*. Pass nitrogen through the

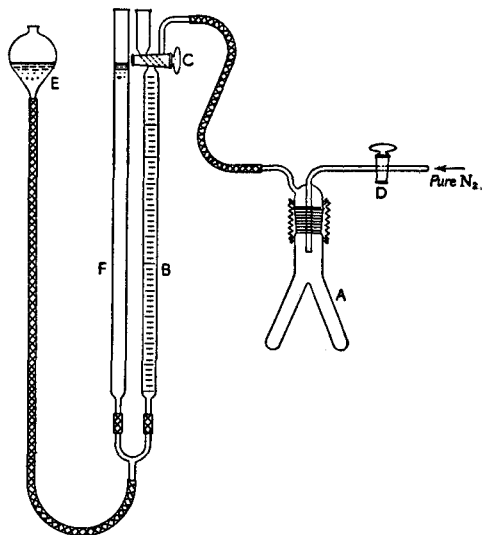

Fig. XXXII, 2, 3.

reaction vessel via the stopcock *D* for 5 minutes. Close stopcock *D* and place the reaction vessel *A* in a large beaker of water at room temperature. After 15 minutes, replace the plug (key) of the stopcock at *C* and turn it so that the burette is open to the air. Fill the gas burette with di-*n*-butyl phthalate by raising the reservoir *E*, and close the tap *C*. Lower the reservoir *E* and turn the tap *C* so as to connect the burette to the reaction vessel *A*. Remove the beaker of water surrounding *A* and cautiously mix the solutions in the two limbs by tilting the vessel slowly from side to side, until gas evolution ceases. To ensure completeness of the reaction, heat the vessel *A* and its contents to 90° in a hot water bath for 15 minutes. Allow the reaction vessel to cool to room temperature, and then immerse in the large beaker (containing water at room temperature) for 10 minutes. Level the reservoir *E*

against the liquid in the gas burette: read the gas volume and also the temperature and the barometric pressure. Reduce the gas volume to N.T.P.

Clean and dry the apparatus, and repeat the determination.

Determine the mean "blank" correction by measuring the volume of gas evolved from the anisole (4.0 ml. portions) by the Grignard solution (10.0 ml. portions). Calculate the mean "blank" correction at N.T.P.

Subtract the "blank" correction from each gas volume, and calculate the percentage of active hydrogen in the sample from each value. Since 1 milli-mol of the compound yields 22.41 ml. of methane at N.T.P. for each active hydrogen, evaluate the number of active hydrogen atoms from the known molecular weight.

### XXXII,3. DETERMINATION OF ACTIVE HYDROGEN WITH METHYL MAGNESIUM IODIDE IN DIETHYL ETHER

It must be emphasised that the procedure utilising diethyl ether as solvent is applicable only to relatively non-volatile, ether-soluble compounds with functional groups reacting completely at room temperature.

#### PREPARATION OF THE GRIGNARD REAGENT (IN DIETHYL ETHER)

Prepare the reagent with the aid of the apparatus of Fig. XXXII, 2, 1 using 8.0 g. (excess) of magnesium turnings and a solution of 35 g. (15.5 ml.) of pure methyl iodide in 200 ml. of sodium-dried ether by an obvious modification of the procedure given in Section XXXII,2. When all the methyl iodide solution has been introduced into the flask, reflux very gently on a water bath for 1 hour. Allow to cool. Decant the liquid into a 300 ml. brown glass-stoppered bottle from which the air has been displaced by oxygen-free nitrogen. After some hours, re-decant the reagent and make up the volume to 250 ml. with anhydrous ether. This reagent will keep for several months if excessive contact with air is avoided.

#### PROCEDURE

All the apparatus must be dried in the steam oven or at 100° before use. Fit up the apparatus shown in Fig. XXXII, 3, 1. It is recommended that the calibrated 50 ml. nitrometer should be surrounded by a glass jacket to exclude draughts; the thermometer can be suspended inside the jacket. Fill the nitrometer

with dry mercury, and fit the reservoir with a rubber stopper carrying a 25 ml. graduated dropping funnel. Place about 0.5 ml.

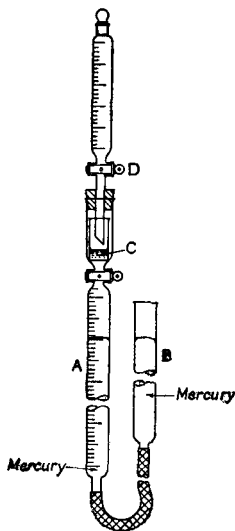

Fig. XXXII, 3, 1.

of anhydrous ether above the mercury in *A*. Weigh out accurately 20–40 mg. of the sample (*e.g.*, 35–40 mg. of benzoic acid, acetic acid, quinol or cyclohexanol, or 20–25 mg. of salicylic acid) into a wide specimen tube and place it in *C*; add 2 ml. of dry ether, and replace the stopper and the tap funnel. Adjust the mercury level in *A* to the zero mark, and close tap *D*. Test the apparatus for leaks by moving *B* up and down about equal distances and for about equal periods, after which the level in *A* should return to zero. Pipette 3.0 ml. of the methyl magnesium reagent into the funnel (use a rubber bulb or equivalent device attached to the upper end of the pipette—Figs. XV, 5, 3 and XV, 5, 4), lower *B* and allow about 2 ml. of the reagent to enter dropwise by manipulating tap *D*, until no further reaction takes place. Adjust the level in *B* so that it is slightly above that in *A*, set the apparatus aside for

10 minutes, level *B* and read the volume in *A*.

Carry out a blank determination: this should not exceed 2 ml. per ml. of reagent used. Under normal conditions, provided draughts be excluded and the room temperature is not too high, constant readings can be obtained over periods of at least 15 minutes.

### CALCULATION

The volume (ml.) of methane evolved at a pressure equal to atmospheric pressure ( $p$ ) minus the vapour pressure of diethyl ether ( $p'$ ) at the temperature of the experiment =  $v_{\text{obs.}}$  = (the reading in *A*) — (the volume of reagent run in) — (blank reading). The theoretical volume of methane per gram atom of active hydrogen is given by :

$$v_{\text{calc.}} = \frac{\text{Weight (g.)}}{\text{Mol. Wt.}} \times 22415 \times \frac{p}{(p - p')} \times \frac{T}{273} = k \times \frac{\text{Weight}}{\text{Mol. Wt.}}$$

Conversion factors  $k$  for a range of temperatures and pressures are given in Table I: these have been calculated from known vapour pressure data.

Calculate the number of active hydrogen atoms in the sample from the relationship  $v_{\text{obs.}}/v_{\text{calc.}}$ .

Clean and dry the apparatus.

TABLE I  
VALUES OF  $k \times 10^{-3}$

Temp.	BAROMETRIC PRESSURE (MM. OF HG)										
	750	752	754	756	758	760	762	764	766	768	770
14°	44.3	44.1	43.9	43.7	43.5	43.2	43.0	42.8	42.6	42.4	42.2
15	45.9	45.7	45.5	45.3	45.0	44.8	44.6	44.4	44.1	43.9	43.7
16	47.7	47.4	47.2	47.0	46.7	46.5	46.2	46.0	45.7	45.5	45.3
17	49.8	49.6	49.3	49.0	48.8	48.5	48.3	48.0	47.7	47.5	47.2
18	52.6	52.3	52.0	51.7	51.4	51.1	50.8	50.5	50.3	50.0	49.7
19	55.7	55.4	55.0	54.7	54.4	54.1	53.7	53.4	53.1	52.8	52.5
20	59.0	58.6	58.2	57.8	57.5	57.1	56.8	56.4	56.0	55.7	55.4
21	62.8	62.4	62.0	61.5	61.1	60.7	60.3	59.8	59.5	59.1	58.8

#### XXXII,4. DETERMINATION OF ACTIVE HYDROGEN WITH LITHIUM ALUMINIUM HYDRIDE IN DI-*n*-BUTYL ETHER

##### PREPARATION OF LITHIUM ALUMINIUM HYDRIDE REAGENT

Finely powder 2.5-3.0 g. of lithium aluminium hydride (1) under pure anhydrous di-*n*-butyl ether (2) in a dry glass mortar in the fume cupboard (hood), and transfer the suspension with the aid of di-*n*-butyl ether (total volume, 250 ml.) to a 500 ml. Pyrex bottle. Close the bottle with a rubber bung which carries a Bunsen valve, and shake the bottle mechanically for 30-60 minutes. [The Bunsen valve (Fig. XXXII, 4, 1) consists of a short length of rubber tubing with a slit in the rubber about 2 cm. long (cut from the inside with a sharp knife) and the outer end of the tube is closed by a glass rod; this valve prevents the entrance of air from without.] Decant the solution through a sintered glass filter funnel into a clean, dry stock bottle from which the air has been displaced by pure nitrogen. Close the bottle with a rubber bung fitted with a Bunsen valve.

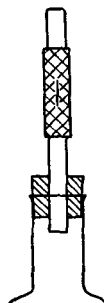

Fig. XXXII, 4, 1.

##### Notes.

(1) Lithium aluminium hydride must be regarded as a *dangerous chemical*. It will ignite on contact with moisture: fires are best extinguished with dry sand. Any residual solid in the mortar should be destroyed by the addition of dry ethyl acetate.

(2) Commercial di-*n*-butyl ether should be purified as follows. It does not usually contain peroxides unless it has been stored for a prolonged period : test for peroxides and if the test is positive, shake the ether with an acidified solution of a ferrous salt or with a solution of sodium bisulphite. Dry the butyl ether with anhydrous magnesium sulphate, and distil it through a fractionating column : collect the fraction of b.p. 140–141°. Reflux over sodium and distil again. Repeat until the sodium is unaffected.

### PROCEDURE

Follow the experimental details given in Section XXXII,2. Use 30–50 mg. of the sample, accurately weighed in 5.0 ml. of dry di-*n*-butyl ether, and 4.0 ml. of the lithium aluminium hydride solution. Determine the solvent “blank”, and deduct this from the gas volume. Repeat the determination.

Calculate the number of active hydrogen atoms in the sample as in Section XXXII,2 ; the molecular weight must, of course, be known.

Clean and dry the apparatus.

## CHAPTER XXXIII

### ENOLS

#### XXXIII.1. DISCUSSION OF SELECTED METHODS FOR THE DETERMINATION OF ENOLS

There are two important methods for the determination of the percentage of enol in a tautomeric keto-enol mixture :

(a) *Bromination.* The enol form generally reacts with bromine much more rapidly than the keto form. By adding an excess of an alcoholic solution of bromine rapidly to a cooled solution of the tautomeric mixture in the same solvent, removing the excess of bromine as rapidly as possible with di-*iso*-butylene, a bromo-ketone is formed :

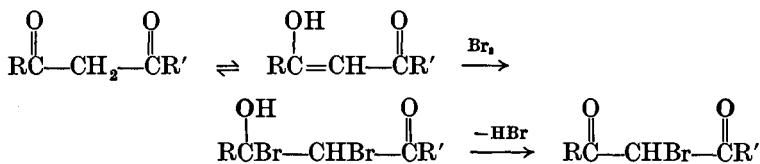

The bromo-ketone may be reduced quantitatively with hydriodic acid and the liberated iodine determined by titration with a standard solution of sodium thiosulphate :

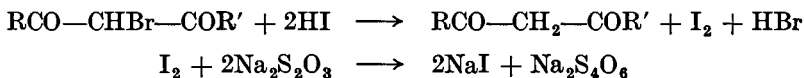

The accuracy of the method depends largely upon the speed with which the excess of bromine is removed, since more of the enol is formed from the keto form as soon as the equilibrium is disturbed. It is assumed that the rate of enolisation is slow. The hydriodic acid does not react rapidly enough with the di-*iso*-butylene to cause an appreciable error.

(b) *Titration in non-aqueous solvents.* Enols are weakly acidic compounds and can be titrated in strongly basic solvents, such as dimethylformamide or ethylenediamine, with a solution of potassium methoxide or of sodium methoxide in benzene-methanol. Thymol blue or azo violet may be used as indicator in dimethylformamide. For very weakly acidic enols, titration should be made in ethylenediamine with *o*-nitroaniline (0.15 per cent. solution in benzene) as indicator. The end point may also be determined potentiometrically: glass and calomel electrodes or antimony and calomel electrodes give reasonably satisfactory results in dimethylformamide.

Enols may also be titrated in pyridine with a solution of a tetra-alkylammonium hydroxide in benzene - methanol (see Section XVIII,1); the end point is best determined potentiometrically using the glass - calomel electrode system.

In general, enols of the general formula  $A-CH_2-A'$  can be titrated as acids in strongly basic solvents if A and A' are any combination of the following electron - attracting groups :  $-COR$ ,  $-CHO$ ,  $-COOR$ ,  $-CONHAr$  or  $-CN$ . The  $-CONH_2$  and  $-CONHR$  groups possess weaker electron - attracting properties : this is supported by the fact that in dimethylformamide as solvent and with azo violet as indicator, malononitrile ( $CN.CH_2.CN$ ) gives a good end point, cyanoacetamide ( $CN.CH_2.CONH_2$ ) yields a poor end point, whilst malonamide ( $CONH_2.CH_2.CONH_2$ ) exhibits no acidic properties. Cyanoacetamide may, however, be titrated in ethylenediamine with o-nitroaniline as indicator.

## XXXIII.2. DETERMINATION OF ENOLS BY TITRATION WITH BROMINE

### REAGENTS

*Methanolic bromine solution, ca. 0·1N.* Dissolve 2·0 g. of dry A.R. bromine in 250 ml. of anhydrous methanol. The solution must always be prepared immediately before use.

*Potassium iodide solution, 10 per cent.* Dissolve 10 g. of A.R. potassium iodide in 100 ml. of water.

*Sodium thiosulphate solution, 0·1N.* See Section XXIX,3.

*Starch indicator solution.* See Section XXIX,3.

### PROCEDURE

Weigh out accurately 1·2–1·6 g. of the sample (*e.g.*, ethyl acetoacetate, acetylacetone or dibenzoylmethane), dissolve it in absolute methanol, and dilute to 100 ml. with absolute methyl alcohol in a volumetric flask. Transfer 25·0 ml. of this solution (use the device shown in Fig. XV, 5, 3 or in Fig. XV, 5, 4) to a dry 150 ml. conical flask, and cool to  $-5^\circ$  to  $-10^\circ$  in an ice-salt freezing mixture. Add an excess of the methanolic bromine solution until a faint yellow colour persists (5–8 ml.). Swirl the solution to effect thorough mixing, and pour in 3 ml. of di-*iso*-butylene immediately. Mix well: if the colour of the bromine is not discharged, add more di-*iso*-butylene. It is essential for the success of the determination that the time consumed in adding the bromine and absorbing the excess should not exceed 15 seconds.

Now add 5 ml. of the potassium iodide solution, warm to  $30^\circ C$ . on a water bath whilst swirling the contents of the flask. Allow to stand for 5 minutes, and titrate the liberated iodine with

standard 0.1*N* sodium thiosulphate until the solution has a light yellow colour, dilute with water add the starch indicator solution, and complete the titration. Repeat the determination until consistent results are obtained.

### CALCULATION

Calculate the percentage of enol in the sample from the formula :

$$\% \text{ Enol} = \frac{V_1 \times N_1 \times M \times 100}{2 \times W \times 1000}$$

where  $V_1$  = volume (ml.) of thiosulphate solution ;  
 $N_1$  = normality of sodium thiosulphate solution ;  
 $M$  = molecular weight of compound ; and  
 $W$  = weight (g.) of sample.

## XXXIII.3. DETERMINATION OF ENOLS BY TITRATION IN NON-AQUEOUS SOLVENTS

### REAGENTS

*Sodium methoxide in benzene-methanol*, ca. 0.1*N*. See Section XVIII.4.

*Azo violet indicator*. A saturated solution of *p*-nitrobenzene-azo-resorcinol in benzene.

*Thymol blue indicator*. Dissolve 0.3 g. of thymol blue in 100 ml. of benzene.

*Dimethylformamide*. It is essential to use a highly purified grade of dimethylformamide ; see Section XVIII.4.

### PROCEDURE

Introduce 25 ml. of dimethylformamide into a 250 ml. conical flask, and add 2 or 3 drops of azo violet or thymol blue indicator. Neutralise any acid impurities in the solvent by titrating with 0.1*N* sodium methoxide to the first appearance of a blue colour. Weigh out accurately 1.5–3.0 milli-equivalents of the enol (*e.g.*, 0.3 of ethyl acetoacetate, acetylacetone or dibenzoylmethane) and stir magnetically (see Fig. XV, 5, 2) until dissolved. Continue the titration until the blue colour is again obtained.

Alternatively, determine the end point potentiometrically.

### CALCULATION

Calculate the percentage of enol in the sample using a formula similar to that given in Section XXXIII.2 with obvious modifications.



## CHAPTER XXXIV

### IMIDES

#### XXXIV.1. DISCUSSION OF THE METHOD FOR THE DETERMINATION OF IMIDES

The determination of imides is a relatively difficult problem ; it has been largely solved by utilising the weakly acidic properties of these compounds. In basic solvents, such as dimethylformamide and ethylenediamine, the acidic properties are so much enhanced that titration becomes possible with a solution of sodium or potassium methoxide in benzene-methanol. A visual indicator, azo violet, may be used to detect the end point. The end point may also be determined potentiometrically with the glass and antimony or with the calomel and antimony electrode systems ; it is essential to clean the surface of the antimony electrode (*e.g.*, by rubbing with fine sand paper) after each titration. Very weakly acidic imides can usually be titrated in ethylenediamine using *o*-nitroaniline (a 0.15 per cent. solution in benzene) as indicator.

Imides may also be titrated in pyridine with a solution of a tetra-alkylammonium hydroxide in benzene - methanol (see Section XVIII,1) ; the end point is determined potentiometrically with the glass - calomel electrode system or visually with azo violet indicator.

In general, compounds of the general formula  $A-NH-A'$  can be titrated as acids in strongly basic solvents if  $A$  and  $A'$  are any combination of the following groups :  $-COR$ ,  $-CHO$ ,  $-COOR$ , and  $-CONHAr$ . If either  $A$  or  $A'$  is  $-CONH_2$  or  $-CONHR$ , the success of the titration is uncertain. Compounds that have been analysed by titration in non-aqueous solvents include phthalimide, succinimide, thiobarbituric acid, barbituric acid, substituted barbituric acids like veronal and phenobarbitone, and hydantoin. It is clear that acids, phenols, amines salts, and thiols may cause interference.

#### XXXIV.2. DETERMINATION OF IMIDES BY TITRATION IN DIMETHYLFORMAMIDE REAGENTS

*Sodium methoxide in benzene-methanol*, ca. 0.1*N*. See Section XVIII,4.

*Dimethylformamide*. See Section XVIII,4.

*Azo violet indicator*. Prepare a saturated solution of *p*-nitrobenzene-azo-resorcinol in A.R. benzene.

### PROCEDURE

Place 20 ml. of dimethylformamide in a 100 ml. conical flask and add 2 drops of azo violet indicator. Stir by means of a magnetic stirrer (Fig. XV, 5, 2). Neutralise any acid impurities in the solvent by titrating with the 0.1*N* sodium methoxide solution to the first appearance of a blue colour. Add 1.5–3.0 milli-equivalents, accurately weighed, of the sample (*e.g.*, 0.2 g. of succinimide, phthalimide, veronal or phenobarbitone), and stir until dissolved. Titrate with the sodium methoxide solution to the first clear blue colour.

The student is recommended to determine the end point also by potentiometric titration with the glass-antimony electrode system.

### CALCULATION

Calculate the purity of the imide from the formula :

$$\% \text{ Purity} = \frac{V_1 \times N_1 \times M \times 100}{W \times 1000}$$

where  $V_1$  = volume (ml.) of sodium methoxide solution used ;

$N_1$  = normality of sodium methoxide solution ;

$M$  = molecular weight of imide ; and

$W$  = weight (g.) of sample.

## CHAPTER XXXV

### SULPHONAMIDES, THIOLS, SULPHIDES AND DISULPHIDES

#### XXXV.1. DISCUSSION OF SELECTED METHODS FOR THE DETERMINATION OF SULPHONAMIDES

The widespread use of sulpha drugs in medicine has led to a great deal of interest in their analysis. One fairly general procedure utilises the fact that the hydrogen in the  $-\text{SO}_2\text{NH}-$  group possesses weakly acidic properties; to titrate it satisfactorily the acidic properties must be enhanced by the use of basic solvents, such as pyridine, dimethylformamide, ethylenediamine or *n*-butylamine. The titrant can be a solution of sodium methoxide, potassium methoxide or tetra-*n*-butylammonium hydroxide in benzene-methanol. Thymol blue may be used as an indicator with pyridine or dimethylformamide: this applies to sulphonamides (including  $\text{ArSO}_2\text{NHAr}'$ ) with  $pK$  less than 10, *e.g.*, sulphapyridine, sulphadiazole, sulphadiazine, sulphamethazine, sulphamerazine but *not* sulphaguanidine. For weaker sulphonamides, *e.g.*, those containing an alkyl group  $\text{ArSO}_2\text{NHR}$ , a more basic solvent is required, such as ethylenediamine or *n*-butylamine; azo violet is the preferred indicator in these two solvents. The end point can also be determined potentiometrically with a glass and antimony electrode system.

Sulphanilamide is not acid to thymol blue, but can be titrated in *n*-butylamine using azo violet as indicator.

Sulphonamides, such as sulphapyridine, sulphadiazine, sulphathiazole and sulphamerazine, which form insoluble silver salts with silver nitrate solution may be determined by dissolution in a mixture of acetone and sodium acetate solution, followed by titration with standard silver nitrate solution in the presence of potassium dichromate solution as indicator. Alternatively, the silver salt may be precipitated with a large excess of silver nitrate solution, dried and weighed.

#### XXXV.2. DETERMINATION OF SULPHONAMIDES BY ACIDIMETRIC TITRATION IN A NON-AQUEOUS SOLVENT

##### REAGENTS

*Sodium methoxide in benzene-methanol*, ca. 0.1*N*. See Section XVIII.4.

*Dimethylformamide*. See Section XVIII.4.

*Thymol blue indicator.* Dissolve 0.3 g. of thymol blue in 100 ml. of methanol.

*Azo violet indicator.* Prepare a saturated solution of *p*-nitrobenzene-azo-resorcinol in benzene.

### PROCEDURE

Place 25 ml. of dimethylformamide in a 250 ml. conical flask, add 2 or 3 drops of thymol blue indicator, and titrate with the 0.1*N* sodium methoxide solution to the first appearance of a blue colour: this will neutralise any acidic impurities in the solvent. Weigh out accurately 0.5–0.6 g. of the sulphonamide (*e.g.*, sulphapyridine, sulphathiazole or sulphadiazine), and stir by means of a magnetic stirrer (Fig. XV, 5, 2) until dissolved. Continue the titration with the standard 0.1*N* sodium methoxide solution to the first appearance of a permanent blue colour.

### CALCULATION

Calculate the percentage purity of the sulphonamide from the formula:

$$\% \text{ Purity} = \frac{V_1 \times N_1 \times M \times 100}{W \times 1000}$$

where  $V_1$  = volume (ml.) of the sodium methoxide solution used;  
 $N_1$  = normality of the sodium methoxide solution;  
 $M$  = molecular weight of the sulphonamide; and  
 $W$  = weight (g.) of the sample.

## XXXV,3. DETERMINATION OF SULPHONAMIDES WITH SILVER NITRATE SOLUTION

### PROCEDURE (VOLUMETRIC)

Weigh out accurately about 200 mg. of the sample (*e.g.*, sulphapyridine, sulphadiazine or sulphathiazole), and dissolve it in a mixture of 25 ml. of acetone and 20 ml. of 10 per cent. sodium acetate solution: warm, if necessary. Add 1 ml. of 0.5 per cent. sodium dichromate solution, and titrate with standard 0.1*N* silver nitrate solution; at the end point, the yellow colour of the solution is replaced by a permanent red colour.

Carry out a blank determination, omitting the addition of the sulphonamide.

### CALCULATION

Calculate the percentage purity of the sample from the formula:

$$\% \text{ Purity} = \frac{(V_1 - V_2) \times N_1 \times M \times 100}{W \times 1000}$$

where  $V_1$  = volume (ml.) of silver nitrate solution used for sample ;  
 $V_2$  = volume (ml.) of silver nitrate solution used for blank ;  
 $N_1$  = normality of silver nitrate solution ;  
 $M$  = molecular weight of the sulphonamide ; and  
 $W$  = weight (g.) of the sample.

### PROCEDURE (GRAVIMETRIC)

Weigh out accurately about 200 mg. of the sulphonamide (*e.g.*, sulphapyridine, sulphadiazine or sulphathiazole), and dissolve it in a mixture of 25 ml. of acetone and 20 ml. of 10 per cent. sodium acetate solution in a 400 ml. beaker : warm, if necessary. Now add 50.0 ml. of standard 0.1*N* silver nitrate solution, and place the beaker on a hot water bath for 30 minutes. Collect the precipitated silver salt on a sintered glass filter (porosity G3) and wash well with water : keep the filtrate. Dry the precipitate to constant weight at 100–120° C.

Calculate the percentage purity of the sample from the formula :

$$\% \text{ Purity} = \frac{\text{Wt. of ppt.} \times \text{Mol. wt. of sulphonamide} \times 100}{\text{Wt. of sample} \times \text{Mol. wt. of silver salt}}$$

As an additional check, add 20 ml. of 10 per cent. nitric acid and 4 ml. of 10 per cent. ferric ammonium sulphate solution to the combined filtrate and washings, and titrate with standard 0.1*N* ammonium thiocyanate solution until a red colour appears.

Calculate the volume of silver nitrate solution used in the precipitation of the silver salt and thence the percentage purity of the sample.

### XXXV.4. DISCUSSION OF SELECTED METHODS FOR THE DETERMINATION OF THIOLS

The following methods may be used :—

(a) *Oxidation with iodine.* Iodine oxidises thiols to disulphides :

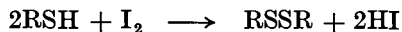

A solution of the mercaptan is treated with a measured excess of standard iodine solution and, after reaction is complete, the excess of iodine is titrated with standard sodium thiosulphate solution.

Primary mercaptans are oxidised smoothly and rapidly to disulphides. Secondary mercaptans are oxidised more slowly and are preferably determined by methods (b) and (c). Tertiary mercaptans alone are smoothly oxidised to sulphenyl iodides in most cases :

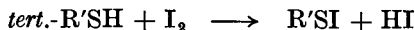

Mixtures of primary and tertiary mercaptans yield mixed disulphides :

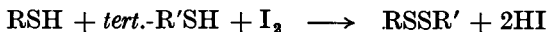

(b) *Precipitation with silver nitrate solution.* The procedure is based upon the precipitation of a solution of the thiol with a measured excess of standard silver nitrate solution, followed by titration of the excess of reagent with standard ammonium thiocyanate solution, using a ferric salt as indicator.

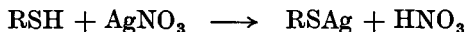

Occlusion of silver ions by the rather lumpy silver mercaptide precipitate and also emulsion formation are considerably reduced by using small aliquots of the sample solution, comparatively dilute silver nitrate and ammonium thiocyanate solutions, and by the addition of an equal volume of methanol prior to titration.

(c) *Oxidation with cupric n-butyl phthalate.* Cupric alkyl phthalates oxidise mercaptans quantitatively with the simultaneous formation of the cuprous mercaptide and the disulphide :

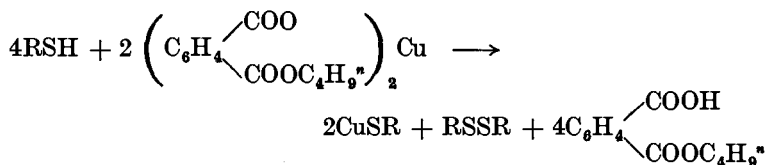

The cupric alkyl phthalate is soluble in hydrocarbon solvents. Direct titration of mercaptans with a solution of the cupric compound is possible: the end point is detected by the blue-green colour of the first excess of the reagent. The procedure is rapid but is not so accurate as the iodine method; the cuprous mercaptide, which is usually yellow, does not affect the titration. Unsaturated compounds do not interfere in the cupric alkyl phthalate method (compare oxidation with iodine). Hydrogen sulphide must, of course, be absent as must also peroxides in the solvents employed.

### XXXV,5. DETERMINATION OF THIOLS BY THE IODINE METHOD

#### REAGENTS

*Iodine solution, 0·1N.* See Section XXII,4.

*Sodium thiosulphate solution, 0·1N.* See Section XVII,2.

*Starch solution, 1 per cent.* See Section XVII,2.

#### PROCEDURE

Weigh out accurately about 0·2 g. of the mercaptan in a sealed glass ampoule (e.g., *n*-octyl mercaptan, *n*-decyl mercaptan or *n*-dodecyl mercaptan), and place it in a 500 ml. iodine flask together with a few glass beads to aid in breaking the ampoule.

Pipette 50.0 ml. of the standard 0.1*N* iodine solution into the flask. Stopper the flask and shake it vigorously to break the ampoule and then for 5 minutes more. Introduce 20 ml. of absolute ethanol and shake for a further 10–15 minutes. Titrate the excess of iodine with the standard 0.1*N* sodium thiosulphate solution, using starch indicator near the end point.

Carry out a blank determination with 50.0 ml. of the iodine solution.

### CALCULATION

Calculate the percentage purity of the mercaptan from the expression :

$$\% \text{ Purity} = \frac{(V_1 - V_2) \times N_1 \times M \times 100}{W \times 1000}$$

where  $V_1$  = volume (ml.) of sodium thiosulphate solution used for blank ;

$V_2$  = volume (ml.) of sodium thiosulphate solution used for sample ;

$N_1$  = normality of sodium thiosulphate solution ;

$M$  = molecular weight of the mercaptan ; and

$W$  = weight (g.) of the sample.

## XXXV,6. DETERMINATION OF THIOLS BY THE ARGENTIMETRIC METHOD

### REAGENTS

*Silver nitrate solution, 0.005*N*.*

*Ammonium thiocyanate solution, 0.005*N*.*

*Ferric alum indicator solution.* Dissolve 4.0 g. of A.R. ferric alum in 10 ml. of *N* nitric acid, boil the solution to remove oxides of nitrogen, cool, and dilute with 30 ml. of distilled water.

### PROCEDURE

Weigh out accurately 1 to 2 milli-equivalents of the mercaptan and dissolve it in 100 ml. of pure benzene in a volumetric flask. Pipette 10.0 ml. of this solution into a 250 ml. conical flask containing 10 ml. of anhydrous methanol. Add about 45.0 ml. of the 0.005*N* silver nitrate solution from a burette to the sample solution ; the latter should be continuously agitated, preferably by means of a magnetic stirrer. Then add 2 ml. of the ferric alum indicator and titrate the solution with 0.005*N* ammonium thiocyanate until a faint pink colour is observed. Discharge the pink colour by adding a slight excess of the standard silver nitrate solution : restore the pink end point by adding the standard ammonium thiocyanate solution dropwise. It is important that the solution be continuously stirred during the titration. Some experience is required in determining the exact end point ; the

pink colour is more clearly observed at the interface between the organic and aqueous layers whilst the stirring is stopped momentarily.

Run a blank determination on the reagents.

### CALCULATION

Calculate the percentage of —SH group in the sample from the formula :

$$\% \text{—SH} = \frac{V_1 \times N_1 \times 33.07 \times 100}{W \times 1000}$$

where  $V_1$  = net volume (ml.) of silver nitrate solution used for the sample;  
 $N_1$  = normality of silver nitrate solution ; and  
 $W$  = weight (g.) of sample.

## XXXV.7. DETERMINATION OF THIOLS BY THE COPPER *n*-BUTYL PHTHALATE METHOD

### REAGENTS

*Cupric n-butyl phthalate.* Use a good grade of phthalic anhydride : it should remain clear when heated in a test-tube to 130°. To 25 ml. of *n*-butanol contained in a 250 ml. conical flask, add 37 g. of finely-ground phthalic anhydride. Insert a thermometer into the flask and heat over a free flame, with stirring, until the temperature rises to 105° C. Remove the flask from the flame but continue the agitation. The temperature continues to rise to 120° C. and the mixture becomes clear in a few minutes. Allow to cool, pour the product into a solution of 10 g. of sodium hydroxide in 750 ml. of water. The resulting solution should be acid to litmus ; if it is not, acidify with acetic acid. Filter the solution into a 2-litre beaker. Add slowly, and with vigorous stirring, a clear solution of 32.5 g. of A.R. cupric sulphate pentahydrate in 250 ml. of water. Collect the precipitated cupric *n*-butyl phthalate on a Buchner funnel by suction filtration, wash well with water, and dry in the air upon sheets of absorbent paper. Powder the solid in a glass mortar, and dry in a vacuum desiccator over concentrated sulphuric acid. The yield is about 95 per cent and the purity is usually 95 per cent or better. Store in a stoppered bottle.

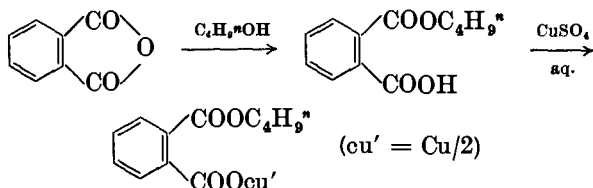

Determine the purity by dissolving a 0.3 g. to 0.5 g. sample in 5 ml. of glacial acetic acid, diluting with 50 ml. of water, adding 2 g. of



A.R. potassium iodide in 10 ml. of water, and titrating the liberated iodine with standard sodium thiosulphate solution.

*Cupric n-butyl phthalate solution, 0·1N.* Weigh out  $(25·29 \times 100)/P$  g. of the cupric *n*-butyl phthalate (*P* is the % purity) into a litre volumetric flask, dissolve it in 50 ml. of acetic acid, and dilute to 1 litre with *n*-butanol or *iso*amyl alcohol or Pentasol (a mixture of the isomers of amyl alcohol). The coefficient of expansion of this solution is about 0·1 per cent. per degree centigrade; it is therefore desirable to keep the difference between the temperature of preparation and of use as small as possible.

Keep the solution in a brown bottle. Discard the solution if an appreciable amount of precipitate forms.

A decinormal solution contains 25·29 g. of cupric *n*-butyl phthalate per litre.

### PROCEDURE

Weigh accurately a sample containing 0·1–0·3 g. of the mercaptan into a 150 ml. glass-stoppered conical flask containing 50 ml. of *n*-butanol or *iso*amyl alcohol. Titrate with the 0·1*N* cupric *n*-butyl phthalate solution by the addition of 0·5 ml. portions until near the end point. The solution may darken during the titration but clears near the end point, which is identified by the persistence of the blue-green colour of the reagent. It is best to observe the end point against a white background with good illumination.

Run a blank experiment in order to determine the volume of reagent required to impart the first detectable blue-green colour to 50 ml. of the solvent. This volume is usually about 0·3 ml.

### CALCULATION

Calculate the percentage of —SH group in the sample from the expression :

$$\% \text{—SH} = \frac{(V_1 - V_2) \times N_1 \times 33·07 \times 100}{W \times 1000}$$

where  $V_1$  = volume (ml.) of reagent used for sample ;

$V_2$  = volume (ml.) of reagent used for blank ;

$N_1$  = normality of the cupric reagent ; and

$W$  = weight (g.) of sample.

## XXXV,8.

### DETERMINATION OF SULPHIDES (THIOETHERS)

#### THEORY

Dialkyl sulphides may be determined either by partial oxidation to sulphoxides or by further oxidation to sulphones with bromine as oxidant :

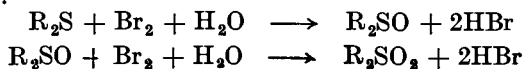

The second stage of the oxidation is much slower than the first. By titrating with the oxidising agent (bromine derived from a bromate-bromide mixture) until a slight excess of bromine is observed, further oxidation to the sulphone is virtually avoided. The bromine colour end point does eventually disappear because of oxidation to the sulphone, but it fades so slowly that the end point can be detected with comparative ease. Compounds which consume bromine readily, *e.g.*, thiols, interfere.

### REAGENTS

*Potassium bromate - potassium bromide solution, 0.1N.* Dissolve 2.78 g. of dry, A.R. potassium bromate (weighed to  $\pm 0.2$  mg.) and 10 g. of A.R. potassium bromide in water and dilute to 1 litre in a volumetric flask. Calculate the exact normality from the weight of potassium bromate taken (compare Sections XVIII,3 and XXIX,3).

*Glacial acetic acid, A.R.*

*Concentrated hydrochloric acid, A.R.*

### PROCEDURE

Weigh out accurately 0.2-0.3 g. of the thioether (*e.g.*, di-*n*-butyl sulphide or di-*n*-octyl sulphide) in an ampoule. Place the ampoule and a few glass beads in a 250 ml. iodine flask containing 40 ml. of glacial acetic acid. Stopper the flask and shake vigorously to break the ampoule. Now add 3 ml. of concentrated hydrochloric acid, followed by 10 ml. of water; use less water if the sample is thrown out of solution. Titrate the solution with the bromate - bromide reagent until the first yellow colour due to excess of bromine is observed. The colour fades slowly (about 1 minute) due to oxidation of the sulphoxide to the sulphone.

Run a blank on the solvents alone to correct for the excess of bromine needed to detect the end point; the blank is usually about 0.2-0.3 ml.

### CALCULATION

Calculate the percentage of sulphide sulphur from the expression :

$$\% \text{—S—} = \frac{V_1 \times N_1 \times 32.06 \times 100}{W \times 1000}$$

where  $V_1$  = volume (ml.) of bromate - bromide solution used for sample and corrected for blank ;

$N_1$  = normality of bromate - bromide solution ;

$W$  = weight (g.) of sample.

## XXXV,9. DETERMINATION OF DISULPHIDES

## THEORY

Disulphides may be analysed by the bromination procedure described for sulphides in the previous Section :

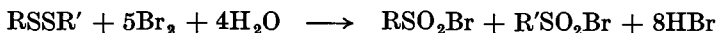

A higher concentration of acid is, however, required to ensure complete reaction : the titration should be conducted at a temperature of 30–50° C. in order to increase the speed of reaction and thus produce a sharper end point.

Disulphides may also be determined by reduction at 50° C. with amalgamated zinc and sulphuric acid in a modified Jones reductor, followed by analysis for the resulting thiols :

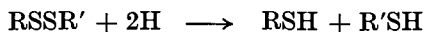

Experimental details for this procedure are not given.

## PROCEDURE

Weigh out accurately about 0.1 g. of the disulphide (*e.g.*, diethyl disulphide or methyl *n*-butyl disulphide) in an ampoule. Place the ampoule and a few glass beads in a 250 ml. iodine flask containing 40 ml. of glacial acetic acid. Add 25 ml. of concentrated hydrochloric acid or of concentrated sulphuric acid, followed (cautiously) by 10 ml. of water ; use less water if the solubility of the disulphide in the medium is low. Warm the resulting solution to 30–50° C., and titrate with the 0.1*N* bromate - bromide until the first yellow colour due to bromine is detected. (It is preferable to employ 0.2*N* bromate - bromide solution, see Section XVIII,3, to reduce the volume of titrant required.)

Run a blank on the solvents alone to correct for the excess of bromine needed to detect the end point.

## CALCULATION

Calculate the purity of the disulphide from the expression :

$$\% \text{ Purity} = \frac{V_1 \times N_1 \times M \times 100}{W \times 1000}$$

where  $V_1$  = volume (ml.) of bromate - bromide solution used for sample and corrected for blank ;

$N_1$  = normality of bromate - bromide solution ;

$M$  = molecular weight of disulphide ; and

$W$  = weight (g.) of sample.

## CHAPTER XXXVI

### DETERMINATIONS USING ION EXCHANGE RESINS

#### XXXVI.1. GENERAL DISCUSSION WITH SPECIAL REFERENCE TO SALTS OF ORGANIC ACIDS AND OF ORGANIC BASES

The phenomenon of ion exchange relates to the interchange of ions that can occur between an electrolyte (in solution) and an ion exchange material; the latter is usually an insoluble, high molecular weight polymer containing ionic groups as an integral part of the polymer structure:

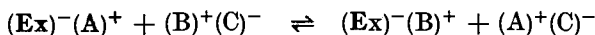

where (Ex) (A) is the exchange material and (B) (C) is the electrolyte. After completion of the reaction, the cation (B)<sup>+</sup>, present in the original electrolyte, has been replaced by (A)<sup>+</sup> originating from the exchange resin: the anions in the resin are unaffected. The above scheme refers to cation exchange resins. Anions may be replaced by the use of suitable anion exchange resins.

Cation exchange resins can be used to replace various organic and inorganic cations with another cation, usually a hydrogen ion. Such resins are preferably of the sulphonated polystyrene type containing free sulphonic acid groups\*; they possess unifunctional character and their exchange action can be represented as:

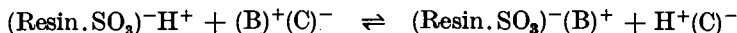

If the ion exchange process is quantitative, titration of the liberated acid H<sup>+</sup>(C)<sup>-</sup> with standard alkali will provide a method for the determination of the salt (B)<sup>+</sup>(C)<sup>-</sup>. Resins containing free carboxyl groups, due to their weakly acidic character, will not generally exchange cations with salts.

Anion exchange resins contain basic groups, such as quaternary ammonium or amino or substituted amino groups; the matrix

\* The cation exchange resins fairly widely used in analytical work are sulphonated styrene-divinylbenzene copolymers. Styrene polymerises in a linear manner, but divinylbenzene produces cross-linking because of its bifunctional character. The degree of cross-linking, assumed to be equal to the percentage of divinylbenzene in the original copolymerisation mixture, varies from 2 per cent to 16 per cent or more. The cross-linking tends to prevent excessive swelling and shrinking as different ions are taken up by the exchange resin.

may be of the cross-linked polystyrene type. Their action in ion exchange may be represented as :

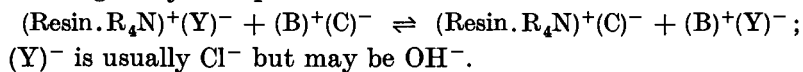

Anion exchange materials may be employed for the analysis of alkaloid salts. Upon passage of an aqueous or alcoholic solution of the salt through a strong anion exchanger, the effluent will consist of a solution of the free alkaloid. The base may be titrated with standard mineral acid, using methyl orange or bromophenol blue as indicator. Neutral salts, such as sodium chloride, interfere. This difficulty may be overcome by ashing the alkaloidal salt, and passing an aqueous extract of the ash through the column : the titre of the effluent will be due to the inorganic salt and can be subtracted from the alkaloid titre.

Two important sources of ion exchange resins are the Permutit Company Ltd. of England and the Rohm and Haas Company of U.S.A. The former supply the "Zeo-Karb" cation exchange resins and "De-Acidite" anion exchange resins, while the latter term their products "Amberlite" ion exchange resins. For the determination of salts of organic acids and bases, the fully-generated free acid forms of the resins should be used, *i.e.*, Zeo-Karb 225(H) or Amberlite IR-120(H). If the less expensive salt forms, *i.e.*, Zeo-Karb 225 or Amberlite IR-120, are employed, they should be soaked for one or two hours in twice their volume of 2-3*N* hydrochloric acid, followed by thorough washing with water to remove mineral acid.

Excellent results can be obtained with such salts of organic acids as ammonium adipate and tartrate ; barium, cadmium, calcium, lead, manganese, nickel (II), silver and sodium acetates ; magnesium and zinc lactates ; potassium acid phthalate ; sodium benzenesulphonate ; sodium benzoate ; sodium citrate ; sodium formate ; sodium oleate and potassium stearate (salts dissolved in 80 per cent. ethanol, and column pretreated with 80 per cent. ethanol before samples applied) ; sodium oxalate ; sodium potassium tartrate ; sodium salicylate ; sodium succinate ; and sodium toluene-*p*-sulphonate. Very satisfactory results are also obtained with salts of organic bases such as aniline hydrochloride, S-benzyl-*iso*-thiuronium chloride, brucine sulphate, hydroxylamine hydrochloride, ephedrine hydrochloride, *o*-methoxyaniline hydrochloride, morphine sulphate, and quinine sulphate.

For the determination of alkaloidal salts with anion exchange resins, a strongly basic resin, *e.g.*, De-Acidite FF or Amberlite IRA-400(Cl), should be used. The resins are supplied as salts (usually the chloride form) ; they should be soaked for one hour in 2*N* sodium hydroxide solution before use, followed by washing with water to remove alkali. This treatment converts the resins into the hydroxyl form.

## XXXVI.2. DETERMINATION OF SALTS OF ORGANIC ACIDS WITH THE AID OF CATION EXCHANGE RESINS

### PREPARATION OF CATION EXCHANGE COLUMN

Prepare the ion exchange column in a 50 ml. burette (1) as follows. Insert a plug of clean glass wool about 1 cm. long immediately above the glass stopcock, and fill the burette with distilled water to the 20 ml. mark. Prepare a suspension of the cation exchange resin, Zeo-Karb 225(H) or Amberlite IR-120(H), in distilled water and pour it slowly into the burette through a wide-stemmed funnel. As the resin settles, tap the burette gently with a wooden rule: this will ensure a uniform bed of resin and also eliminate any air bubbles. Continue the addition of the suspension until the resin bed is at the 25 ml. mark. It may be necessary to run out some water from the burette, but it is essential that the column of resin be covered with liquid (say, at least 1 cm. above the top of the bed) at all times; drying out and possible channeling is thus prevented (2).

### PROCEDURE

Weigh out accurately 0.8–1.0 milli-equivalent of the salt (say, 0.12 g. of sodium benzoate, 0.15 g. of sodium salicylate or 0.20 g. of sodium toluene-*p*-sulfonate) into a 250 ml. conical flask, and dissolve it in 40 ml. of water. Pass this solution through the column via a separatory funnel (supported by means of a grooved cork in the top of the burette) at a rate of 1 ml. per minute. This is followed by 50 ml. of water (first used to rinse out the conical flask) at the same rate. Collect the liquid passing out of the column in a 250 ml. conical flask. Titrate the effluent with standard 0.1*N* sodium hydroxide solution contained in a semi-micro burette, using phenolphthalein as indicator. A mixed indicator consisting of one part of 0.04 per cent. aqueous cresol red and three parts of 0.04 per cent. aqueous thymol blue is particularly useful when dilute solutions of alkali must be employed.

Run a blank determination using the same total volume of distilled water, and apply a correction, if necessary, to the sodium hydroxide solution consumed in the actual determination.

### Notes.

(1) An alternative apparatus consists of a glass tube about 30 cm. long, the lower half of about 10 mm. and the upper portion of about 20 mm. diameter. The lower end is closed by a glass tap, and just above this is fused a sintered glass plate of porosity 0 to support the resin.

(2) The efficiency of the resin may be checked by determining the purity of A.R. sodium oxalate.

### CALCULATION

Calculate the purity of the salt from the formula:

$$\% \text{ Purity} = \frac{\text{Vol. (ml.) of NaOH} \times \text{Normality} \times \text{Mol. wt.} \times 100}{\text{Wt. (g.) of sample} \times 1000}$$

### XXXVI.3. DETERMINATION OF SALTS OF ORGANIC BASES WITH THE AID OF CATION EXCHANGE RESINS

#### PROCEDURE

Proceed exactly as described in the previous Section, but use 0.8–1.0 milli-equivalent of the salt of the organic base (*e.g.*, 0.12 g. of aniline hydrochloride or of *p*-toluidine hydrochloride, or 0.15 g. of *S*-benzyl-*iso*-thiuronium hydrochloride).

Carry out a blank determination using the same total volume of distilled water and apply a correction, if necessary, to the volume of standard 0.1*N* sodium hydroxide solution consumed in the actual analysis of the sample.

Calculate the purity of the salt of the organic base as in Section XXXVI.2.

### XXXVI.4. DETERMINATION OF ALKALOIDAL SALTS WITH THE AID OF ANION EXCHANGE RESINS

#### PREPARATION OF ANION EXCHANGE COLUMN

Prepare a column about 10 cm. long of De-Acidite FF or of Amberlite IRA-400(Cl) following the experimental details given in Section XXXVI.2 for the cation exchange resin. Convert the resin into the hydroxyl form by passing 300 ml. of 2*N* potassium or sodium hydroxide through the column at a rate of 1 drop per 2 seconds. Wash the column with distilled water until 50 ml. of the effluent gives a titration of less than 0.1 ml. of 0.1*N* sulphuric acid using methyl orange or bromophenol blue as indicator : about 250 ml. of water are required (1).

#### PROCEDURE

Weigh out accurately about 0.11 g. of the alkaloid salt (*e.g.*, ephedrine hydrochloride) and dissolve it in 10 ml. of water in a small conical flask. Transfer the solution to a 25 ml. separatory funnel supported at the top of the column by means of a grooved cork, and allow the solution to run through the column at the rate of 1 drop in about 2 seconds : collect the effluent in a conical flask. When only a small volume of liquid remains above the resin, rinse the conical flask which contained the sample with 20–25 ml. of distilled water, and run this through the column at a rate not exceeding 2–3 ml. per minute. Stop the flow when the level of liquid just covers the resin. Titrate the total effluent with standard 0.1*N* sulphuric acid, using bromophenol blue or methyl orange as indicator. Pass a further 25 ml. of distilled water through the column, and titrate the effluent. Repeat the process until the titre is less than 0.1 ml. of 0.1*N* sulphuric acid.

Carry out a blank determination using the same total volume of water and apply a correction to the volume of sulphuric acid consumed in the analysis, if necessary.

**Note.**

(1) An alternative procedure for preparing the hydroxyl form is to cover the resin with 2*N* potassium or sodium hydroxide solution for 1 hour, and then to wash it with distilled water until free from alkali. The column is charged with the resulting product.

**CALCULATION**

Calculate the purity of the alkaloidal salt with the aid of a formula similar to that given in Section XXXVI,2.

For ephedrine hydrochloride :

$$1 \text{ Ml. } 0.1N \text{ H}_2\text{SO}_4 \equiv 0.02017 \text{ g. of alkaloidal salt.}$$

**XXXVI,5. DETERMINATION OF THE  
SAPONIFICATION EQUIVALENTS OF ESTERS.  
ALKALI HYDROLYSIS - ION EXCHANGE METHOD**

**THEORY**

Ion exchange may be applied with advantage to the quantitative hydrolysis of esters (see Sections XXV,1-XXV,4). After the saponification, the reaction product is diluted with 50 per cent. aqueous methanol and passed through a cation exchange column in the hydrogen form. The excess of potassium or sodium hydroxide is neutralised and the carboxylate is converted into the free carboxylic acid. The carboxylic acid is then titrated with standard sodium hydroxide solution.

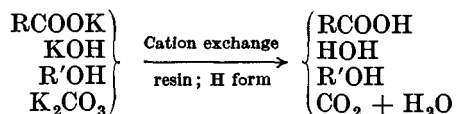

The advantages of the alkali saponification-ion exchange procedure are :

(i) A more concentrated alkali hydroxide solution may be employed, thus reducing considerably the digestion time and also the volume of reagent required.

(ii) The viscous potassium hydroxide solution need not be measured accurately with a pipette ; slight discolouration of the reagent is not usually harmful.

(iii) Only one direct titration is necessary. This is the titration of the colourless eluate with standard sodium hydroxide solution. The alkali hydroxide solution used for the hydrolysis need not be standardised.



(iv) The solution does not require protection from carbon dioxide during the hydrolysis: any carbonate formed will be decomposed in the ion exchange column and the carbon dioxide present can be boiled off before titration.

The hydrolysis reagents described in Sections XXV,1–XXV,4 may still be used, but it is better to increase their concentrations and thereby reduce both the time required for complete hydrolysis and the total volume of the reaction mixture. The following concentrations are suitable:

(a) Aqueous potassium hydroxide, 2*N*; for esters which are soluble in water or which are easily saponified. The addition of an alcohol, such as *isopropyl* alcohol, increases the speed of hydrolysis.

(b) Alcoholic potassium hydroxide, 2*N*: for water-insoluble esters.

(c) Potassium hydroxide in diethyleneglycol, 1*N*: for most esters and particularly those which are hydrolysed with difficulty.

## REAGENTS

*Aqueous potassium hydroxide*, ca. 2*N*. Prepare from A.R. potassium hydroxide pellets.

*Alcoholic potassium hydroxide*, ca. 2*N*. Prepare by a modification of the procedure given in Section XXV,3.

*Potassium hydroxide in diethyleneglycol*, ca. 1*N*. Prepare by a modification of the procedure given in Section XXV,4.

*Aqueous sodium hydroxide*, 0.05*N*. Prepare from A.R. sodium hydroxide pellets and standardise with A.R. potassium hydrogen phthalate.

*Methanol-water*. Mix equal volumes of absolute methanol and water.

*isopropyl alcohol*. The pure commercial product is satisfactory.

*Ion exchange column*. Prepare a cation exchange column in a 50 ml. burette as detailed in Section XXXVI,2. Use about 20 g. of Zeo-Karb 225(H) or Amberlite IR-120(H), 40–80 mesh, Drain off most of the water, and wash three or four times with 20 ml. portions of methanol-water before use.

It is advisable to replace the resin in the ion exchange column after each determination. When sufficient of the used resin has been collected, it may be regenerated by stirring it well with 2–3*N* hydrochloric acid for 1–2 hours, and then washing thoroughly with water until the washings are neutral. The resin is then ready for use.

## PROCEDURE

*With 2*N* aqueous potassium hydroxide*. Use 0.2–0.5 g. (1–2 milliequivalents) of the ester (*e.g.*, methyl or *n*-butyl salicylate, or

di-*n*-butyl oxalate), 2.5 ml. of the reagent, and 8 ml. of *iso*-propyl alcohol in a 50 ml. round-bottomed flask equipped with an efficient reflux condenser. Heat under reflux for 30–60 minutes. Cool the flask, and add about 25 ml. of methanol - water.

*With 2N alcoholic potassium hydroxide.* Proceed exactly as for aqueous potassium hydroxide but use 5 ml. of the reagent. Suitable esters for practice in this determination include benzyl acetate and di-*n*-butyl phthalate.

*With 1N potassium hydroxide in diethyleneglycol.* Weigh out accurately 0.2–0.3 g. of the ester (*e.g.*, diethyl phthalate or di-*n*-butyl phthalate) into a 50 ml. glass-stoppered conical flask (an iodine flask is suitable) and add 10 ml. of the reagent. Mix the reagent and ester by gently swirling the contents of the flask. Hold the glass stopper firmly in place and heat the flask in an oil bath so that a temperature of 70–80° C. is reached in 2–3 minutes. Remove the flask from the bath and shake vigorously whilst still holding the stopper in position: this will dissolve any vapourised ester. Allow the liquid to drain and then cautiously loosen the stopper in order that air may escape. Replace the stopper and continue the heating until the temperature is 120–130° C. [With esters of very high boiling point, the stopper may be removed and a thermometer inserted.] Heat for 3–4 minutes at 120–130° C., cool the flask and contents to about 80° C., remove the stopper, wash it with about 25 ml. of methanol - water and allow the rinsings to drain into the flask.

The experimental procedure after hydrolysis of the ester by any of the three saponification reagents is similar. Pass the solution through the ion exchange column; collect the eluate in a 250 ml. conical flask. Wash the column with five 20 ml. portions of methanol - water. Heat the combined column effluent to boiling (in order to expel any dissolved carbon dioxide), cool to room temperature and titrate with standard 0.05*N* sodium hydroxide, using phenolphthalein as indicator.

Run a blank on the alcohol and potassium hydroxide solution by passing it through the ion exchange column, etc. Subtract this titre from that obtained for the titration of the products of hydrolysis.

### CALCULATION

Calculate the saponification equivalent of the ester from the formula :

$$\text{Saponification equivalent} = \frac{W \times 1000}{V_1 \times N_1}$$

where  $W$  = weight (g.) of sample;

$V_1$  = volume (ml.) of sodium hydroxide solution used for sample less correction for blank; and

$N_1$  = normality of sodium hydroxide solution.

Alternatively, calculate the purity of the ester from the expression :

$$\% \text{ Purity} = \frac{V_1 \times N_1 \times M \times 100}{W \times n \times 1000}$$

where  $V_1$  = volume (ml.) of sodium hydroxide solution used for sample less correction for blank ;

$N_1$  = normality of sodium hydroxide solution ;

$M$  = molecular weight of ester ;

$W$  = weight (g.) of sample ; and

$n$  = basicity of carboxylic acid produced.

## CHAPTER XXXVII

### SOME APPLICATIONS OF THE KARL FISCHER REAGENT

#### XXXVII.1. THE KARL FISCHER REAGENT: DESCRIPTION AND GENERAL METHOD OF USE

For the determination of small amounts of water, Karl Fischer (1935) proposed a reagent prepared by the action of sulphur dioxide upon iodine dissolved in pyridine and methyl alcohol. The main reaction in methanol appears to proceed in two distinct steps :

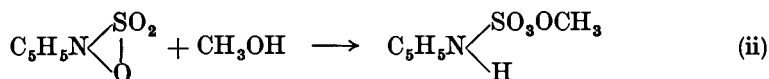
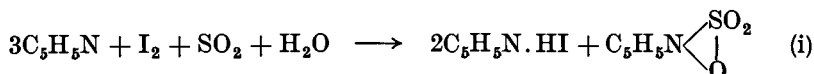

The first step (i) is the oxidation of the sulphur dioxide by the iodine and takes place only in the presence of an oxygenated molecule which leads to the intermediate compound, pyridine-sulphur trioxide; the latter is the "inner salt" of pyridinium hydroxide-*N*-sulphonic acid. The second step (ii), the formation of the methyl ester, prevents the pyridine complex from reacting with another molecule of water or other active hydrogen compound. Hence one molecule of iodine is equivalent to one molecule of water.

The original Karl Fischer reagent is prepared with excess of methanol, which therefore serves the dual purpose of acting as a diluent and reacting with the pyridine-sulphur trioxide formed in the primary reaction with iodine, sulphur dioxide and pyridine. This methanolic reagent is somewhat unstable and requires frequent standardisation. A more stable reagent may be prepared by substituting ethylene glycol monomethyl ether (methyl Cellosolve) for methanol.

When the reagent is freshly prepared, it has a deep reddish-brown colour; the spent reagent has a pale straw-yellow colour, so that the reagent may serve as its own indicator. The Karl Fischer reagent undergoes auto-decomposition with time; the decomposed reagent has a brownish colour, thus rendering the detection of a colour change with the human eye difficult. It is therefore preferable to add a slight excess of the reagent to the solution of the sample in a dry solvent and to titrate the excess with a standard solution of water in methyl alcohol; the end point is determined electrometrically.

The procedure involving the dead stop end point is generally employed. If a small e.m.f. is applied across two platinum electrodes immersed in the reaction mixture, a current will flow as long as free iodine is present, to remove hydrogen and depolarize the cathode. When the last trace of iodine has reacted, the current will decrease to zero or very close to zero. Conversely, the technique may be combined with a direct titration of the sample with the Karl Fischer reagent: here the current in the electrode circuit suddenly increases at the first appearance of unused iodine in the solution. A simple apparatus for this purpose is shown in Fig. XXXVII, 1, 1.

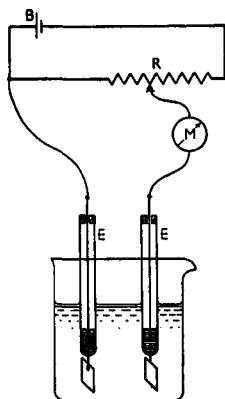

Fig. XXXVII, 1, 1.

$B$  is a 3 volt torch battery,  $M$  is a micro-ammeter,  $R$  is a 500 ohm, 0.5 watt radio potentiometer, and  $EE$  are platinum electrodes. The potentiometer is set so that there is a potential drop of about 80 milli-volts across the electrodes, and does not require adjustment until the battery is almost exhausted.

The Karl Fischer reagent may be standardised with a standard solution of water in methanol (say, containing 5–6 mg. per ml.) or with pure disodium tartrate dihydrate; the latter contains 15.66 per cent. of water.

The reagent in its simplest form can only be applied to liquids which comply with the following requirements:—

(a) They do not react with the reagent or with a component of the reagent; nor may they react with the hydrogen iodide formed in the reaction to yield water (as in acetal or ketal formation).

(b) They are miscible with the reagent and, preferably, do not cause precipitation of the pyridine complexes formed during the titration.

(c) They will conduct an electric current.

## XXXVII.2. SOME APPLICATIONS OF THE KARL FISCHER REAGENT: THEORETICAL DISCUSSION

One of the greatest advances achieved by the use of the Karl Fischer reagent is the determination of the water content of organic liquids which are miscible with water and, in many cases, hygroscopic: these include methanol, ethanol, *n*- and *isopropanols*, ethylene and propylene glycols, glycerol, methyl acetate, ethyl acetate, monomethyl- and monoethyl-ethers of ethylene glycol (methyl and ethyl Cellosolve), formic acid, and

acetic acid. The water contents of solvents which are sparingly soluble in water may be determined by mixture with anhydrous methanol or other suitable anhydrous solvent.

Other applications are :—

(1) *Water content of hydrated salts and other organic compounds.* The water contents of the following compounds are readily determined : sodium acetate, disodium tartrate, lactic acid, oxalic acid, oleic acid, tartaric acid, citric acid, sulphanilic acid, glycine, phenol, *o*-cresol,  $\gamma$ -butyrolactone, ethylal, diethyl ether, methyl Cellosolve, Carbitol, 1 : 4-dioxan, formamide, dimethylformamide, ethylenediamine, aniline, pyridine, quinoline, phenyl isocyanate, nitromethane, ethanalamine, phenylhydrazine hydrochloride, D-glucose, and *o*-phenanthroline.

(2) *Alcoholic hydroxyl (primary, secondary and tertiary).* The alcohol is treated at 67° with a large excess of acetic acid, containing boron trifluoride as catalyst, and the water formed (which is equivalent to hydroxyl) is titrated with the Karl Fischer reagent :

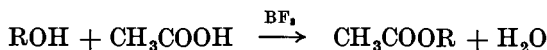

(3) *Organic acids.* The organic acid is treated with a large excess of methanol containing boron trifluoride as esterification catalyst, and the water formed is determined :

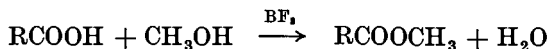

(4) *Acid anhydrides.* Hydrolysis of the acid anhydride is effected in the presence of pyridine, using sodium iodide as catalyst :

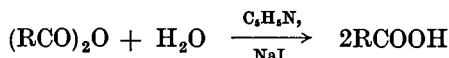

The excess of water is titrated with the Karl Fischer reagent.

(5) *Carbonyl compounds.* The procedure is based upon the reaction :

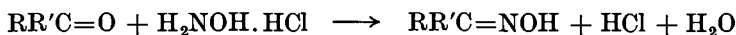

For satisfactory end points, the excess of hydroxylammonium ion must be removed and this can be done effectively by a solution of sulphur dioxide in pyridine :



Accordingly, the carbonyl compound is treated with a methanolic solution of hydroxylamine hydrochloride and heated at 60° for 2 hours ; after cooling to room temperature, a solution of sulphur dioxide and pyridine in methanol is added and the mixture is

allowed to stand for 10–60 minutes. The water produced is then titrated with the Karl Fischer reagent.

(6) *Primary and secondary amines.* The amine is mixed with excess of a solution of pure acetic anhydride in pyridine, and the residual acetic anhydride is evaluated by reaction with excess of water at 60° (in practice, the hydrolysing agent is a solution of sodium iodide in pyridine containing a known amount of water), and determining the excess of water with the Karl Fischer reagent :

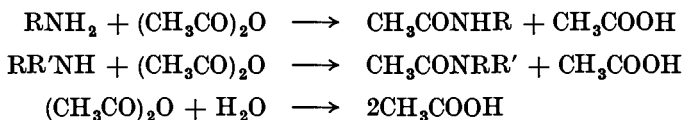

*Primary amines* may be analysed by utilising the Schiff type of reaction :

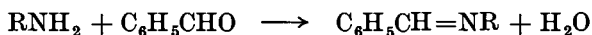

The reagent consists of a solution of pure benzaldehyde in pyridine; this reacts quantitatively with the amine at 60°. The excess of benzaldehyde is removed by shaking with a little dry sodium cyanide and a solution of hydrogen cyanide in pyridine.

(7) *Nitriles.* The analysis is based upon the selective hydrolysis of the nitrile in the presence of an acid catalyst,  $\text{BF}_3 \cdot 2\text{CH}_3\text{COOH}$  :

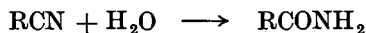

The hydrolysis reagent is the compound  $\text{BF}_3 \cdot 2\text{CH}_3\text{COOH}$  containing a known amount of water. Hydrolysis is effected at 80°, excess of pyridine is added to combine with the boron trifluoride, and the residual water is determined in the usual manner.

Experimental details for a selection of the above determinations are given in the following Sections.

### XXXVII,3. PREPARATION OF THE KARL FISCHER REAGENT: APPARATUS FOR ITS USE

A relatively stable Karl Fischer reagent is prepared as described below. The molar ratio of iodine to pyridine to sulphur dioxide is maintained at 1 : 10 : 3, as in the original Karl Fischer reagent. It is essential that the components of the reagent be pure and free from water. Commercial ethylene glycol monomethyl ether (methyl Cellosolve) usually has a water content of less than 0.1 per cent. and can then be used without further purification; if the water content is suspected or known to be higher than this

figure, it may be decreased by distilling off about 5 per cent. through a small column and using the remaining 95 per cent.

Dissolve 133 g. of resublimed iodine in 425 ml. of pure, anhydrous pyridine in a dry, glass-stoppered bottle and add 425 ml. of anhydrous methyl Cellosolve. Cool the mixture in an ice bath. Add, in small quantities and with constant swirling, 70 ml. of anhydrous liquid sulphur dioxide (kept in an ice-salt bath) from a graduated cylinder. Mix thoroughly. The resulting Karl Fischer reagent has volume of about 1 litre. The water equivalent is approximately 6 mg. of water per ml. of reagent.

The most widely used reagent for standardisation is a solution of water in methanol, which is prepared as follows. Fill a dry 1-litre, glass-stoppered volumetric flask to within 100 ml. of the mark with anhydrous methanol ( $< 0.1$  per cent. of water\*), and place it in a thermostatically-controlled water bath at  $25^{\circ}$ , together with a small flask containing about 200 ml. of the same methanol. Weigh out accurately about 15 g. of distilled water into the litre flask and, after the contents have acquired the temperature of the water bath, adjust the volume to the mark with methyl alcohol from the smaller flask.

A simple apparatus for titrations with the Karl Fischer reagent is illustrated in Fig. XXXVII, 3, 1 (not drawn to scale). The Fischer reagent and the "standard water" solution are separately contained in dark-coloured bottles; both solutions are pumped into their respective burettes by hand-bellows, the air passing into the bottles being dried by a calcium chloride tower. The burettes are of 10 ml. capacity, graduated in 0.02 ml., and are closed by small calcium chloride tubes having a short length at the top of the tube filled with silica gel or cotton wool to prevent "caking" of the calcium chloride: this involves no danger of loss of water from the "standard water" solution, which is very dilute. The titration vessel has a ground-glass B34 neck and a capacity of about 60 ml. It carries a well-fitting Bakelite stopper drilled with holes to take the two burettes, the two glass tubes with sealed-in platinum wires, the stirrer and an inlet attached to a drying train through which nitrogen from a cylinder of compressed gas is passed continuously into the vessel; the drying train consists of a calcium chloride tower, two wash bottles containing concentrated sulphuric acid, and a silica gel or anhydrous calcium sulphate tube. All the tubes passing through the stopper are treated with sealing wax to give an air-tight seal; the stirrer and stopper are thickly coated with a suitable inert grease. A tap is provided to allow titrated solutions to be run off and replaced by dry nitrogen, thus avoiding the necessity of removing the

\* See *Elementary Practical Organic Chemistry*, Part I, *Small Scale Preparations*, Section II, 36, 5.



titration vessel after each titration and the exposure of the dry, hygroscopic solvent on the interior of the vessel to atmospheric moisture. The solution to be titrated is introduced through the narrow side arm, which at all other times is closed with a small drying tube, the end of which is ground to fit the B7 ground-glass neck of the side arm. The bottles, the burettes, the electric motor for driving the stirrer, and the titration vessel are mounted on a

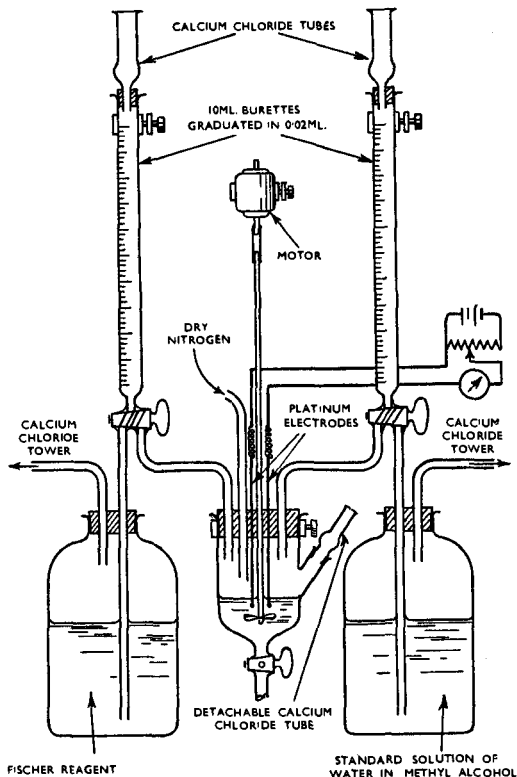

Fig. XXXVII, 3, 1.

wooden stand and baseboard. A self-contained portable potentiometer may be used to apply an e.m.f. of about 80 milli-volts to the platinum electrodes: the dead stop method of titration is employed.

In practice, it is more convenient to employ a commercial form of Karl Fischer apparatus. A typical apparatus is shown in Figs. XXXVII, 3, 2 and XXXVII, 3, 3\*. Two 25 ml. burettes,

\* Supplied by Baird and Tatlock (London) Ltd., Freshwater Road, Chadwell Heath, Essex, England.

mounted on the face of the metal cabinet, are fitted with three-way stopcocks which permit suction of the reagents into the burettes, and either delivery into the titration vessel or drainage back into the reservoir. Each reservoir can hold 1 litre of reagent and each is fitted with a special funnel to facilitate rapid filling. Both the reservoirs and the burettes are protected by large guard tubes filled with desiccant (silica gel, etc.). The titration vessel has a ground top which fits into a rubber gasket, and is held in position by a spring-loaded stirrer housing, thus ensuring an air-tight

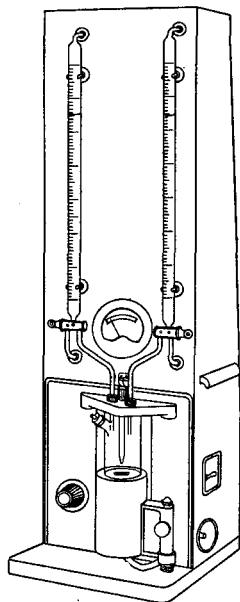

Fig. XXXVII, 3, 2.

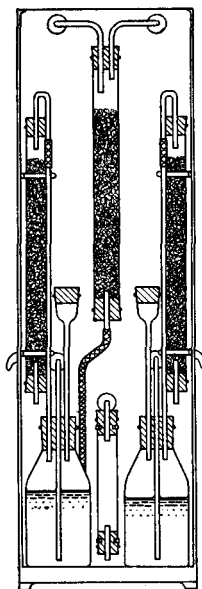

Fig. XXXVII, 3, 3.

joint. When the vessel is in position, it communicates with the atmosphere only by means of a vent tube housed within the cabinet. An alternative titration vessel, provided with a side arm closed by a ground glass cap, is also supplied and is very convenient in use. The stirrer has an iron core sealed in glass and is operated magnetically; stirring speed is controlled by a rheostat mounted to the left of the stirrer unit. The electrode unit consists of a pair of bright platinum electrodes in a partitioned glass tube: they are connected to a micro-ammeter, which acts as the end point indicator. The scale of the micro-ammeter is marked "Excess Fischer" and "Excess Water": warning of the approach of the end point is given by momentary kicks of the needle as each drop of liquid is added.

For the standardisation of the Karl Fischer reagent, the experimental details to be given are those for the commercial apparatus; they can be readily adapted for the apparatus of Fig. XXXVII, 3, 1.

*By means of a standard solution of water in methanol.* Dry the beaker, stirrer and electrode system using acetone and a stream of dry air. Rapidly add 2–3 drops of water from a weighing bottle (compare Fig. XIV, 1, 5) to the beaker, and immediately fit the beaker in position on the apparatus. Add the Karl Fischer reagent in 1 ml. portions at about two second intervals. Switch on the stirrer after a few ml. have been added, and continue the titration until a permanent iodine colour is obtained. The meter needle will now swing over to "Excess Fischer". Back titrate the excess of Fischer reagent with the standard water-in-methanol solution at a rate of about 1 drop per second until the meter needle begins to oscillate; continue the titration until one drop causes a large deflection and the needle reads "Excess Water". Stirring must not be vigorous and should be maintained at a steady rate throughout the titration. Record the volumes of reactants added, and also the exact weight of water used.

Calculate the strength of the Fischer reagent in terms of milligrams of water per ml. of solution from both results. A useful check on the standard solution of water in methanol is thus available.

Reproducible standardisation figures are sometimes difficult to obtain because of variation in the amount of adsorbed water present in the apparatus. The following modified procedure may be used. Transfer 20.0 ml. of anhydrous methanol to the titration beaker, stir, and add the Karl Fischer reagent until about 1.0 ml. excess is present. Now titrate to the end point with the standard water-in-methanol solution. Introduce 3 drops of water as rapidly as possible through the side arm of the beaker, titrate with the Karl Fischer reagent until a permanent iodine colour is obtained and the needle of the meter is at "Excess Fischer" add 1.0 ml. more of the reagent. Titrate the excess of Fischer reagent with the standard water-in-methanol solution. Run in a further 10.0 ml. of the water-in-methanol solution, titrate with the Karl Fischer reagent until a known excess is present, and back-titrate the excess with the water-in-methanol solution. Several determinations of the strength of the Karl Fischer reagent can thus be made.

*By disodium tartrate dihydrate.* Place 25.0 ml. of absolute methanol in the titration vessel and titrate with the Karl Fischer reagent. Add 0.5–0.6 g. of pure disodium tartrate dihydrate (15.66 per cent. water), accurately weighed, stir, and titrate again with the Karl Fischer reagent. The salt dissolves completely before the titration is completed.

Calculate the mg. of water equivalent to 1 ml. of the Karl Fischer reagent from the formula (compare calculation under *Glycerol* in Section XXXVII,4) :

$$\text{Mg. of H}_2\text{O per ml.} = \frac{\text{Mg. of sample} \times 0.1566}{\text{Ml. of reagent}}$$

#### XXXVII.4. DETERMINATION OF THE WATER CONTENT OF SOLVENTS, ETC. WITH THE KARL FISCHER REAGENT

First, standardise the reagent, *i.e.*, determine the number of mg. of water equivalent to 1 ml. of the Karl Fischer reagent.

**Glycerol.** Weigh out accurately about 10 g. of glycerol into the titration vessel, and add 20.0 ml. of absolute methanol (of known water content from a prior determination—see below). Run in the Karl Fischer reagent until a slight excess (*ca.* 1 ml.) is present, and back titrate the excess with standard water-methanol solution.

Some typical results follow.

1 Ml. of Karl Fischer reagent  $\equiv$  6.66 mg. of water.

1 Ml. of standard H<sub>2</sub>O/MeOH solution contains 3.04 mg. of water.

Weight of glycerol used . . . . .	=	8.5140 g.
Volume of Karl Fischer reagent added . . . . .	=	23.52 ml.
Excess of K.F. reagent $\equiv$ 1.90 ml. of H <sub>2</sub> O/MeOH . . . . .	=	0.87 ml.
Volume of K.F. reagent $\equiv$ 20.0 ml. of methanol . . . . .	=	0.41 ml.
$\therefore$ Titre of K.F. reagent . . . . .	=	22.24 ml.

This is equivalent to 22.24  $\times$  6.66 mg. = 0.1481 g. of water.

$\therefore$  Water content of glycerol = 0.1481  $\times$  100 / 8.5140 = 1.74 %.

**Dimethylformamide.** Place 20.0 ml. of absolute methanol in the titration vessel. Add a slight excess of the Karl Fischer reagent and back titrate with the standard water-methanol solution ; this will remove the water from the methanol and also that absorbed by the titration vessel. Now add 10.0 ml. of dimethylformamide, and titrate with the Karl Fischer reagent in the usual manner.

Some typical results follow.

1 Ml. of Karl Fischer reagent  $\equiv$  6.66 mg. of water.

Volume of Karl Fischer reagent added . . . . .	=	2.00 ml.
Excess of K.F. reagent $\equiv$ 1.18 ml. of H <sub>2</sub> O/MeOH . . . . .	=	0.54 ml.
$\therefore$ Titre of K.F. reagent . . . . .	=	1.46 ml.

$\therefore$  Water content of dimethylformamide

$$= \frac{1.46 \times 6.66 \times 100}{10.0 \times 1000} = 0.098 \% \text{ (w/v).}$$

**Methanol.** Standardise the reagent as in Section XXXVIII,3. Partially empty the titration vessel : the standardisation immediately prior to the determination helps to eliminate errors due to

adsorbed water on the titration beaker, etc. Introduce 25.0 ml. of the sample of methanol, add the Karl Fischer reagent until about 1 ml. excess is present, and back titrate with standard water-in-methanol solution. Calculate the percentage of water (w/v) in the sample of methanol.

It is interesting to note that methanol prepared from commercial "absolute" methyl alcohol with magnesium activated by iodine (*Elementary Practical Organic Chemistry*, Part I, *Small Scale Preparations*, Section II, 36,5) had a water content (w/v) of 0.025 per cent.; upon exposure to the atmosphere for 30 minutes, this rose to 0.205 per cent.

**Ethanol, methyl Cellosolve, pyridine, ethyl acetate, di-*n*-butyl ether, glacial acetic acid, and benzene.** The student should determine the water contents of the above solvents by a procedure similar to that given under *Methanol*. Some typical results (w/v) obtained were: commercial absolute ethanol, 0.07 per cent.; methyl Cellosolve, commercial, 0.11 per cent.; pyridine, a pure commercial product, 0.50 per cent.; ethyl acetate, commercial, 0.14 per cent.; di-*n*-butyl ether (a student's preparation), 0.30 per cent.; glacial acetic acid, 0.45 per cent.; benzene, purified and stored over sodium, 0.009 per cent.

**Sodium acetate.** Titrate 20.0 ml. of absolute methanol to remove water, etc. as detailed under *Dimethylformamide*. Weigh out accurately about 0.2 g. of crystallised sodium acetate ( $\text{CH}_3\text{COONa} \cdot 3\text{H}_2\text{O}$ ) into the methanol, stir, and titrate in the usual manner (slight excess of Karl Fischer reagent, and back titration with standard water-in-methanol solution).

Some typical results follow.

1 ml. of Karl Fischer reagent  $\equiv$  6.66 mg. of water.

Weight of sample	.	.	.	.	=	0.1671 g.
Volume of Karl Fischer reagent added	.	.	.	.	=	11.00 ml.
Excess of K.F. reagent $\equiv$ 2.29 ml. of $\text{H}_2\text{O}/\text{MeOH}$	.	.	.	.	=	1.05 ml.
$\therefore$ Titre of K.F. reagent	.	.	.	.	=	9.95 ml.

$$\therefore \text{Water content of sample} = \frac{9.95 \times 6.66 \times 100}{0.1671 \times 1000} = 39.65 \%$$

It is of interest to note that a stock bottle containing A.R. anhydrous sodium acetate, after powdering in a glass mortar, was found to have a water content of 9.98 per cent.

### XXXVII.5. DETERMINATION OF PRIMARY AMINES WITH THE KARL FISCHER REAGENT REAGENTS

*Acetylating reagent.* Mix 14.2 ml. of A.R. acetic anhydride with sufficient anhydrous pyridine to make 100 ml. of solution.

*Hydrolysis reagent.* Dissolve 10.0 g. of A.R. sodium iodide in 100 ml.

of pyridine to which 2.2 ml. of water have been added. Hydrolysis occurs rapidly in pyridine solution and is accelerated by the sodium iodide, which acts as a catalyst.

#### PROCEDURE

Weigh out accurately 3–4 milli-equivalents of the amine (*e.g.*, about 0.3 g. of aniline) into a dry 350 ml. iodine flask, add 20 ml. of the acetic anhydride-pyridine reagent, mix, and allow the mixture to stand for 1 hour. Add 20 ml. of the hydrolysis reagent, and heat the flask in a water bath at 50–60° for 1 hour; loosen the stopper from time to time to release the expanded air. Allow to cool to room temperature, and titrate directly for water with the Karl Fischer reagent.

Carry out a blank determination exactly as above but omitting the addition of the amine.

Calculate the purity of the amine from the net weight of water produced in the acetylation.

### XXXVII.6. DETERMINATION OF ACETIC ANHYDRIDE WITH THE KARL FISCHER REAGENT

#### PROCEDURE

Weigh out accurately about 0.3 g. of the sample of acetic anhydride into a 100 ml. or 250 ml. glass-stoppered conical flask (an iodine flask is satisfactory). Add 10.0 ml. of the pyridine-sodium iodide-water reagent (hydrolysis reagent, see Section XXXVII.5). Allow to stand overnight *or* heat in a water bath at 50–60° for 1 hour. Titrate the cold reaction mixture for water with the Karl Fischer reagent.

Run a blank determination at the same time as the analysis.

Calculate the acetic anhydride content of the sample from the net weight of water produced, *i.e.*, allowing for the blank determination.

## CHAPTER XXXVIII

### ALPHA-EPOXY GROUPS (OXIRANE COMPOUNDS)

#### XXXVIII.1. DISCUSSION OF SELECTED METHODS FOR THE DETERMINATION OF ALPHA-EPOXY GROUPS

$\alpha$ -Epoxydes, or oxirane compounds, are a group of cyclic ethers in which the oxygen atom forms a three-membered ring with two adjacent carbon atoms,  $\text{—C—C—}$ . Because of the strained



three-membered ring,  $\alpha$ -epoxydes are the most reactive of the oxides and are far more reactive than ordinary ethers. Thus they react with hydrogen chloride to form the corresponding chlorohydrins:

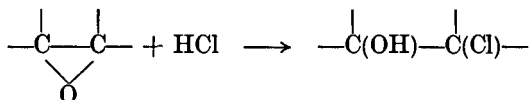

This reaction forms the basis of procedures for the determination of  $\alpha$ -epoxy groups.

The reagent employed is either a solution of hydrogen chloride in anhydrous diethyl ether (prepared by passing dry hydrogen chloride gas into the anhydrous ether until the concentration is about 0.2*N*) or a solution of hydrochloric acid in dioxan (prepared by adding sufficient concentrated hydrochloric acid to fairly dry, purified dioxan to produce a 0.2*N* solution). Reaction times are about 3 hours for the former and about 15 minutes for the latter. In view of the volatility of the diethyl ether reagent and the longer reaction time, the solution of hydrochloric acid in dioxan is generally preferred.

A known weight of the epoxide is added to a measured volume of the reagent (excess) and, after reaction is complete, the residual hydrochloric acid is determined by titration with standard alkali. The difference between the amount of acid present before and after reaction is taken as a measure of the  $\alpha$ -epoxide content. This is termed the *acidimetric method*.

Alternatively, the acidimetric titration may be substituted by a Volhard titration. After reaction at room temperature, the excess of chloride ion is determined by titration with standard silver nitrate solution, etc., using ferric thiocyanate as indicator. The difference in the chloride concentration present before and

after the reaction is used to evaluate the  $\alpha$ -epoxide content. This may be called the *argentimetric method*.

## XXXVIII.2. DETERMINATION OF ALPHA-EPOXIDES BY THE ACIDIMETRIC METHOD

### REAGENTS

*Hydrochloric acid in dioxan*, ca. 0.2N. Pipette 1.6 ml. of concentrated hydrochloric acid, sp. gr. 1.19, into 100 ml. of purified dioxan contained in a brown, glass-stoppered bottle. Mix thoroughly, and inspect to confirm that the reagent is homogeneous: water in the dioxan tends to make dissolution slow or incomplete. The reagent must be prepared as required since it deteriorates on standing.

*Neutral ethanol*. Add 1 ml. of cresol red indicator solution (0.1 g. of cresol red in 100 ml. of 50 per cent. ethanol) to 100 ml. of ethyl alcohol, and neutralise to the first violet colour with 0.1N methanolic sodium hydroxide solution.

*Methanolic sodium hydroxide*, 0.1N. Dissolve 2.0 g. of A.R. sodium hydroxide in 250 ml. of A.R. methanol, warming if necessary. Cool to room temperature, dilute to 500 ml., and allow to stand for 24 hours. Decant or filter off any solid which separates. Standardise with A.R. potassium hydrogen phthalate, preferably at the temperature at which the alkali solution will be used. The coefficient of expansion of this solution is 0.13 per cent. per degree centigrade; it is therefore desirable to keep the difference between the temperature of preparation and of use as small as possible.

### PROCEDURE

Pipette 25.0 ml. of the hydrochloric acid-dioxan reagent into a 500 ml. glass-stoppered flask (an iodine flask is satisfactory). Weigh out accurately about 0.1 g. of the epoxy compound into the flask (*e.g.*, epichlorohydrin  $\text{O} \cdot \text{CH}_2 \cdot \text{CH} \cdot \text{CH}_2\text{Cl}$ , 2:3-epoxy-propyl phenyl

ether (phenyl glycidic ether)  $\text{C}_6\text{H}_5 \cdot \text{O} \cdot \text{CH}_2 \cdot \text{CH} \cdot \text{CH}_2 \cdot \text{O}$ , 2:3-epoxy-

propyl *p*-methoxyphenyl ether (*p*-methoxy-phenyl glycidic ether)  $\text{CH}_3\text{O} \cdot \text{C}_6\text{H}_4 \cdot \text{O} \cdot \text{CH}_2 \cdot \text{CH} \cdot \text{CH}_2 \cdot \text{O}$ , or 1:2-epoxy-ethylbenzene

$\text{C}_6\text{H}_5 \cdot \text{CH} \cdot \text{CH}_2 \cdot \text{O}$ ; use an ampoule if the compound is a liquid).

Stopper the flask and swirl to effect solution. Allow the reaction mixture to stand at room temperature for 15 minutes. Add 25 ml. of neutral ethyl alcohol, and titrate the excess of acid with the standard 0.1N methanolic sodium hydroxide. The colour of the indicator changes from pink to yellow just before the end point and from yellow to violet at the end point.

Perform a blank titration with 25.0 ml. of the hydrochloric acid-dioxan reagent: the difference between the titration of the



blank and of the sample is the volume of sodium hydroxide solution equivalent to the acid consumed by the epoxide.

If the sample contains free acid, determine the free acid content by dissolving a 0.2 g. sample of the compound in 40–50 ml. of neutral ethanol and titrating with the standard 0.1*N* methanolic sodium hydroxide. Calculate the result as ml. of the standard alkali for the weight of sample employed in the epoxy determination. Let the resulting value be  $V_3$  ml.

### CALCULATION

Calculate the percentage of oxirane oxygen from the formula :

$$\% \text{ Oxirane oxygen} = \frac{V_1 - (V_2 - V_3) \times N_1 \times 16.00 \times 100}{W \times 1000}$$

where  $V_1$  = volume (ml.) of sodium hydroxide solution used for the blank ;

$V_2$  = volume (ml.) of sodium hydroxide solution used for sample ;

$V_3$  = volume of sodium hydroxide solution used for the titration of the free acid in the sample ;

$N_1$  = normality of the sodium hydroxide solution ; and

$W$  = weight (g.) of the sample.

## XXXVIII.3. DETERMINATION OF ALPHA-EPOXIDES BY THE ARGENTIMETRIC METHOD

### REAGENTS

*Hydrochloric acid in dioxan*, ca. 0.2*N*. See Section XXXVIII.2.

*Silver nitrate solution*, 0.1*N*.

*Ammonium thiocyanate solution*, 0.05*N*.

*Nitrobenzene*, A.R.

*Nitric acid*, ca. 30 per cent. Mix 34.5 ml. of concentrated nitric acid with 69 ml. of distilled water, and aerate to remove oxides of nitrogen.

*Ferric nitrate indicator solution*. Dissolve 7.8 g. of A.R. ferric nitrate,  $\text{Fe}(\text{NO}_3)_3 \cdot 8\text{H}_2\text{O}$ , in 25 ml. of distilled water, and add 5 ml. of aerated 30 per cent nitric acid.

### PROCEDURE

Pipette 25.0 ml. of the hydrochloric acid-dioxan reagent into a 500 ml. glass-stoppered flask (an iodine flask is suitable). Weigh out accurately about 0.1 g. of the epoxy compound (use an ampoule if the compound is a liquid). Stopper the flask and swirl to effect solution. Allow the reaction mixture to stand at room temperature for 15 minutes. Then add 50 ml. of distilled water, 5 ml. of 30 per cent. nitric acid and 3.0 ml. of the ferric nitrate indicator solution, followed by 0.5 ml. of the 0.05*N* ammonium thiocyanate solution from a burette. Swirl constantly and titrate with the standard silver nitrate solution until

the red colour is discharged ; then add 2 to 3 ml. in excess. Add 10 ml. of nitrobenzene, stopper the flask and shake it vigorously for 15-20 seconds. Titrate slowly with the standard ammonium thiocyanate solution until the end point is approached as indicated by a more slowly fading red colour. Stopper the flask, shake vigorously for 20-30 seconds, and continue the titration until one drop produces a distinct reddish colouration which does not fade upon vigorous shaking.

Perform at least one, and preferably two, blank experiments on the reagents in an identical manner, omitting the sample.

If the sample contains free halide, determine the halide content in a similar manner but omit the hydrochloric acid from the dioxan. Calculate the result as ml. of standard silver nitrate solution for the weight of sample employed in the epoxy determination. Let the resulting value be  $V_3$  ml.

### CALCULATION

Calculate the percentage of oxirane oxygen from the formula :

$$\% \text{ Oxirane oxygen} = \frac{V_1 - (V_2 - V_3) \times N_1 \times 16.00 \times 100}{W \times 1000}$$

where  $V_1$  = net volume (ml.) of silver nitrate solution used for blank ;  
 $V_2$  = net volume (ml.) of silver nitrate solution used for sample ;  
 $V_3$  = net volume (ml.) of silver nitrate solution used for titration  
of free halide in the sample ;  
 $N_1$  = normality of silver nitrate solution ; and  
 $W$  = weight (g.) of sample.

## CHAPTER XXXIX

### MISCELLANEOUS DETERMINATIONS

#### XXXIX.1. DETERMINATION OF FORMALDEHYDE

##### THEORY

This compound is usually encountered as an aqueous solution ("formalin") containing about 33 to 37 per cent. by weight of formaldehyde. Stronger solutions polymerise spontaneously to paraformaldehyde. Two methods will be described for the determination of formaldehyde in the commercial aqueous solution.

Formaldehyde is oxidised quantitatively to formic acid by excess of iodine in alkaline solution. The effective oxidising agent is probably sodium hypoiodite, and the formic acid formed is neutralised by the alkali present :

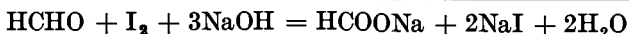
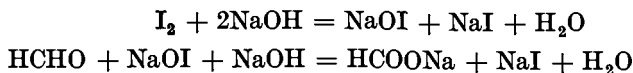

When the oxidation is complete, the solution is acidified with hydrochloric acid, and the liberated iodine is titrated with standard sodium thiosulphate solution ; this, of course, is the excess of iodine not utilised in the oxidation :

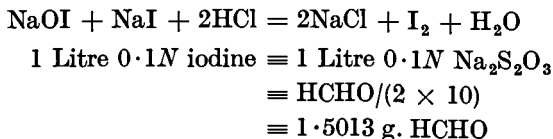

The above procedure is applicable only to dilute solutions of formaldehyde (concentration < 1 per cent.). Other aldehydes and most ketones must be absent.

An aqueous neutral solution of formaldehyde reacts with hydroxylamine hydrochloride (neutralised to bromophenol blue) :



the acid liberated in the reaction is titrated with standard sodium hydroxide solution.

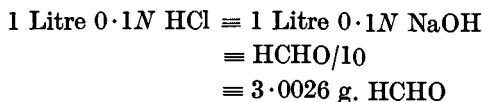

Other aldehydes and ketones must be absent.

**PROCEDURE**  
**(SODIUM HYPOIODITE METHOD)**

Weigh out accurately about 1.0 g. of formalin solution (compare Fig. XIV, 1, 5) into a 250 ml. volumetric flask, and dilute with distilled water to the mark. Mix well. Transfer 25.0 ml. of the solution by means of a pipette (see Figs. XV, 5, 3 and XV, 5, 4) to a 250 ml. conical flask, and add 50.0 ml. of 0.1*N* iodine solution. Immediately introduce *ca.* 2*N* sodium hydroxide solution until the liquid becomes pale yellow in colour. After 10 minutes, acidify with *ca.* 2*N* hydrochloric acid, and titrate the excess of iodine with standard 0.1*N* sodium thiosulphate solution, using starch as indicator.

Carry out a blank determination to check the normality of the iodine solution and also to deduce the net volume of standard thiosulphate solution equivalent to the sample.

**CALCULATION**

Calculate the percentage of formaldehyde in the formalin solution using the relationship :

$$1 \text{ ML. } 0.1N \text{ I}_2 \equiv 1 \text{ ML. } 0.1N \text{ Na}_2\text{S}_2\text{O}_3 \equiv 0.001501 \text{ g. HCHO}$$

Alternatively, use the following formula :

$$\% \text{ HCHO} = \frac{(V_1 - V_2) \times N_1 \times M \times 100}{W \times 2 \times 1000}$$

where  $V_1$  = volume (ml.) of thiosulphate solution used for blank ;  
 $V_2$  = volume (ml.) of thiosulphate solution used after reaction of sample with iodine solution ;  
 $N_1$  = normality of sodium thiosulphate solution ;  
 $M$  = molecular weight of formaldehyde (30.026) ; and  
 $W$  = weight (g.) of sample.

**PROCEDURE**  
**(HYDROXYLAMINE HYDROCHLORIDE METHOD)**

Weigh out accurately about 0.3 g. of the formalin solution into a 250 ml. conical flask, add 25 ml. of distilled water and 2 drops of bromophenol blue indicator (0.5 per cent. solution in ethanol). Carefully neutralise the solution by the addition of 0.1*N* sodium hydroxide solution. Add 10.0 ml. of 10 per cent. aqueous hydroxylamine hydrochloride by means of a pipette (compare Figs. XV, 5, 3 and XV, 5, 4) ; allow to stand for 10 minutes and shake frequently. Titrate the liberated hydrochloric acid with standard 0.1*N* sodium hydroxide solution.

Perform a blank experiment, omitting the aldehyde, and subtract the titre of the blank from that of the sample. The end point is not very sharp, and some care and experience is needed

in detecting the correct end point. The final solution in the blank experiment is useful for purposes of comparison.

### CALCULATION

Calculate the percentage of formaldehyde in the formalin solution :

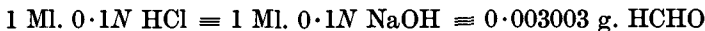

Alternatively, use the following formula :

$$\% \text{ HCHO} = \frac{(V_1 - V_2) \times N_1 \times M \times 100}{W \times 1000}$$

where  $V_1$  = volume of sodium hydroxide solution used in the analysis ;

$V_2$  = volume of sodium hydroxide solution used in blank ;

$N_1$  = normality of sodium hydroxide solution ;

$M$  = molecular weight of formaldehyde (30.026) ; and

$W$  = weight (g.) of sample.

## XXXIX.2. DETERMINATION OF ACETONE

### THEORY

Acetone reacts with iodine in the presence of sodium hydroxide solution to yield iodoform and sodium acetate :

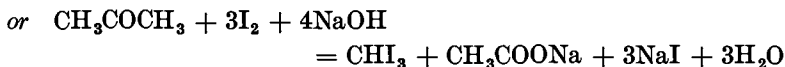
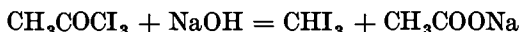
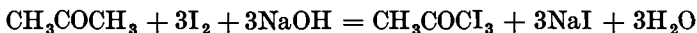

A dilute aqueous solution of the sample is added to a known volume of 1N sodium hydroxide solution, followed by an excess of standard 0.1N iodine solution. After acidification, unreacted iodine is determined by titration with standard 0.1N sodium thiosulphate solution :

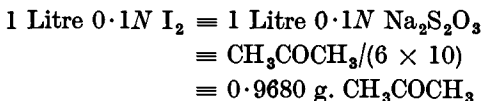

The above procedure is sometimes termed Messinger's method. Aldehydes, compounds which contain an acetyl group, or a group oxidisable by hypoiodite to an acetyl group, interfere ; compounds containing a  $-\text{CH}=\text{CHC}=\text{O}$  group (e.g., acrolein or furfuraldehyde) will consume iodine and therefore interfere. Methyl and ethyl alcohols should also be absent.

### PROCEDURE

Place a measured volume of an aqueous solution of the sample containing about 0.01–0.025 g. of acetone\* in a 500 ml. iodine flask. Dilute to about 200 ml. with distilled water. Add 25.0 ml. of *N* sodium hydroxide solution, mix well, and allow to stand at room temperature for 5 minutes. Introduce from a burette 50.0 ml. of 0.1*N* iodine solution whilst shaking the flask constantly with a swirling motion. Allow the mixture to stand for 15 minutes at room temperature. Then add 26 ml. of *N* sulphuric acid thus rendering the solution acidic, and titrate immediately with standard 0.1*N* sodium thiosulphate solution to the starch end point.

Run a blank determination, omitting the acetone.

### CALCULATION

Calculate the percentage of acetone in the sample using the relationship :

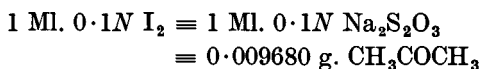

Alternatively, use a formula similar to that given for Formaldehyde (sodium hypoiodite method) in Section XXXVIII,1.

## XXXIX,3. DETERMINATION OF AROMATIC HYDRAZINES (GASOMETRIC METHOD)

### THEORY

Aromatic hydrazines are converted by cupric sulphate in acid solution into the diazonium salts and the latter are decomposed by heating in a stream of carbon dioxide : the liberated nitrogen is collected in a nitrometer over potassium hydroxide solution and its volume measured.

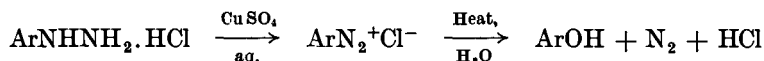

### APPARATUS

Assemble the apparatus shown in Fig. XXXIX, 3, 1. *A* is a 250 ml. two-necked flask, *B* is a 50 ml. dropping funnel, *C* is a short condenser which is connected to a 100 ml. nitrometer *D* by means of a capillary tube *E*. The nitrometer is charged with

\* For practice in this analysis, dilute 10.0 ml. of A.R. acetone to 500 ml. in a volumetric flask ; dilute 25.0 ml. of the resulting solution to 500 ml., mix well, and use 25.0 ml. for each titration.

50 per cent. sodium hydroxide solution (100 g. of A.R. potassium hydroxide in 100 ml. of water) and a layer of mercury at the bottom; the level of the mercury extends about 1 cm. above the entrance tube to the nitrometer and prevents the potassium hydroxide solution reaching the capillary tube and also clogging of the capillary *E* with potassium carbonate produced by the carbon dioxide used in the experiment. The cork *F* may serve to provide an additional point for clamping the apparatus. The reservoir at the top of the nitrometer and the levelling bulb are

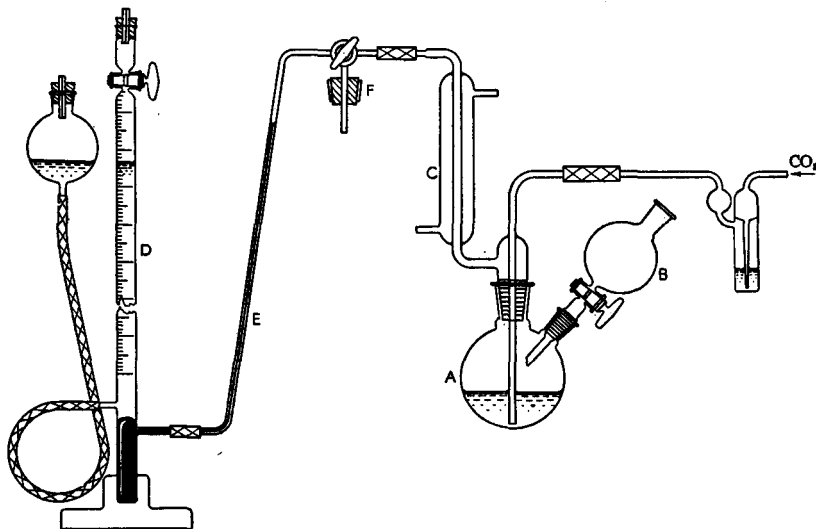

Fig. XXXIX, 3, 1.

closed with rubber bungs penetrated by short lengths of capillary tubing, thus keeping the potassium hydroxide solution almost out of contact with the air.

### PROCEDURE

Weigh out accurately about 0·15 g. of the aromatic hydrazine (*e.g.*, phenylhydrazine hydrochloride) into the reaction flask *A*, and introduce two small carborundum chips. Assemble the apparatus and adequately lubricate all ground glass joints (*e.g.*, with Silicone stopcock grease). Add through the dropping funnel *B* 40 ml. of saturated copper sulphate solution, followed by 10 ml. of concentrated sulphuric acid. Pass a stream of pure carbon dioxide (*e.g.*, from a Kipp's apparatus—see Section XIV,2) through the apparatus until all the air is expelled, *i.e.*, until

the bubbles rising in the nitrometer are of micro size and no detectable volume is registered in the nitrometer after 10–15 minutes. To conserve the potassium hydroxide solution, the carbon dioxide may be allowed to pass out through *F* during the first 5–10 minutes.

Heat the reaction flask gently and gradually raise the temperature until the contents of the flask boil : maintain this gentle ebullition until the reaction is complete, which is indicated by the fact that the volume of nitrogen in *D* ceases to increase. Stop the heating of the reaction flask and disconnect the apparatus by suitably turning the tap at *F*. Allow the nitrometer to stand for 1 hour. Read the volume of nitrogen collected in *D*, and also the temperature on a thermometer supported near the nitrometer ; record the barometric pressure.

### CALCULATION

Calculate the purity of the sample of the aromatic hydrazine.

Correct the volume of nitrogen for the vapour pressure of the potassium hydroxide solution etc. as in Section XIV,2. Let *V* = corrected volume of nitrogen (in ml.) at N.T.P. The molecular weight in grams of the aromatic hydrazine yields 22,415 ml. of nitrogen at N.T.P. Utilise this fact to calculate the purity of the aromatic hydrazine.

## XXXIX,4. DETERMINATION OF UREA (GASOMETRIC METHOD)

### THEORY

Urea is decomposed by alkaline sodium hypobromite solution in accordance with the equation :

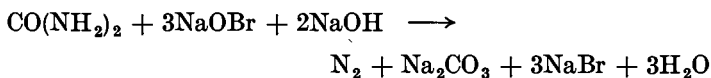

Thus 1 gram mol of urea (60.06 g.) should give 22.415 litres of nitrogen at N.T.P. or 1 gram of urea should give 373.2 ml. of nitrogen. In practice it is found that the reaction is not quite quantitative (1 gram of urea yields 357.0 ml. of nitrogen at N.T.P.), due to the small amount of ammonium cyanate which is in equilibrium with carbamide in aqueous solution :

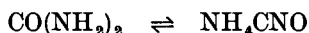

A correction must therefore be applied to the volume of nitrogen collected in the experiment.



## APPARATUS

A simple apparatus is illustrated in Fig. XXXIX, 4, 1 (not drawn to scale). The reaction is carried out in a 100 or 150 ml. conical flask *A* closed by a rubber stopper. *B* is a small specimen tube; *C* is a graduated gas burette and *D* is a levelling tube, both of which are securely fastened to a wooden board *E*; *F* is a stopcock to enable easy levelling of the liquid in *C* and *D* to be made either by running water out through the tap or adding water through the open end; *G* is a large beaker containing water at the temperature of the laboratory. All connexions are made with heavy-walled rubber tubing ("pressure" tubing) and must be gas-tight.

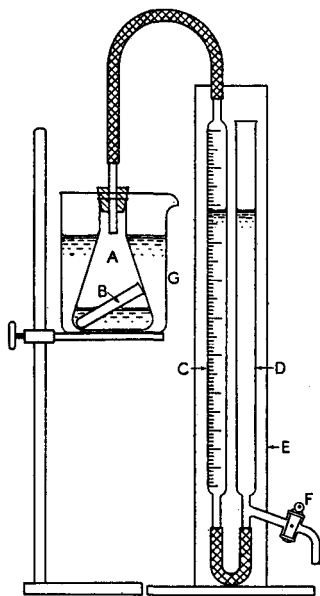

Fig. XXXIX, 4, 1.

## PROCEDURE

Prepare the sodium hypobromite solution by dissolving 50 g. of sodium hydroxide in 250 ml. of water, cooling in an ice bath to 0–5°, and slowly adding 12.5 ml. of A.R. bromine with stirring. Place 60 ml. of the sodium hypobromite solution in the conical flask *A*.

Weigh out accurately about 100 mg. of the sample of urea into the small specimen tube *B*, and lower it carefully into the conical flask with the aid of a pair of forceps: it is sometimes preferable to attach a thread of cotton to the rim of the specimen tube and to hold it in position by means of the rubber stopper. Fit the stopper securely into *A* and immerse the latter in the water bath *G*. Adjust the levels of the water in *C* and *D* so that they are the same in both limbs. When thermal equilibrium is attained (usually after standing for 30 minutes), equalise the levels in the gas burette and levelling tube, and read the level of the meniscus. Now tilt the reaction flask *A* so that the urea and hypobromite solution mix thoroughly: nitrogen is evolved. Run off water from *F* so that approximately the same level is maintained in the tubes *C* and *D*. After the evolution of nitrogen has ceased, allow the reaction flask *C* to cool to the temperature of the bath (about 90 minutes). Equalise the levels in the gas burette and levelling tube. Note the reading in the gas burette *C*, the temperature of the water in *G*, and the barometric pressure.

## CALCULATION

Calculate the percentage of urea in the sample.

Correct the volume of gas evolved to N.T.P., making due allowance for the vapour pressure of the water at the temperature of the bath (see Appendix). Since 1 gram of pure urea yields 357·0 ml. of nitrogen at N.T.P., the purity of the sample can be readily evaluated.

### XXXIX.5. DETERMINATION OF UREA (GRAVIMETRIC METHOD)

## THEORY

Urea reacts quantitatively with a solution of xanthhydrol in methanol or acetic acid to give a precipitate of the highly insoluble di-xanthhydryl urea. The precipitate is filtered off, washed with methanol, dried and weighed.

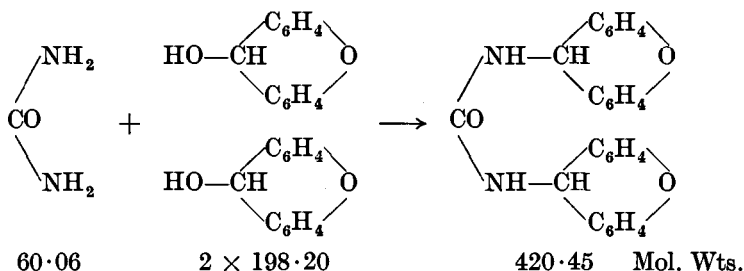

## PROCEDURE

Prepare a 10 per cent. solution of xanthhydrol in methanol (w/v)\*. Weigh out accurately about 60 mg. of urea into a 250 ml. conical flask containing about 25 ml. of distilled water. Add 90 ml. of glacial acetic acid, followed by 13 ml. of the xanthhydrol reagent. Mix well, and allow to stand for 1 hour. Filter off the derivative through a previously weighed sintered glass crucible (porosity G3) or a porcelain filter crucible. Wash with 25–30 ml. of absolute methanol. Dry at 120° C. to constant weight.

## CALCULATION

Calculate the purity of the sample of urea: the factor for converting the weight of the precipitate (di-xanthhydryl urea) into urea is 60·06/420·45 or 0·1425.

\* This reagent can be purchased from British Drug Houses Ltd. and from other suppliers of laboratory chemicals.

## XXXIX,6. DETERMINATION OF ORGANIC PEROXIDES AND HYDROPEROXIDES

### THEORY

Diacyl peroxides, such as benzoyl peroxide, and also hydroperoxides react with a solution of an iodide either in acetic acid or in *isopropyl* alcohol containing some acetic acid to liberate iodine :

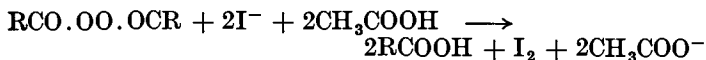

The iodine is then titrated with standard sodium thiosulphate solution :

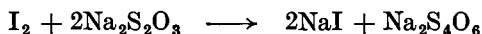

Peroxides may also be determined by reduction with titanous salts (compare Chapter XXVIII) : water or glacial acetic acid may be used as solvent.

### PROCEDURE

*Method 1.* Weigh accurately a sample containing 1 to 2 millimols of the peroxide (*e.g.*, about 0.25 g. of benzoyl peroxide) and dissolve it in 25 ml. of glacial acetic acid. Add 2.0 ml. of saturated, aqueous potassium iodide solution and a few small pieces of Dry Ice (in order to exclude air). Allow the reaction mixture to stand for 10 minutes. Titrate with standard 0.1*N* sodium thiosulphate solution until the brown colour of the iodine commences to fade. Then add 25 ml. of water and 1 ml. of 2 per cent starch solution. Complete the titration in the usual manner.

A blank titration may be performed on the acetic acid, but this is not usually necessary.

The procedure is similar for hydroperoxides except that 4–5 drops of concentrated sulphuric acid are introduced after the addition of the potassium iodide solution. Gentle warming in a stream of carbon dioxide may be employed to accelerate the reaction.

*Method 2.* Into a 150 ml. conical flask fitted with an efficient reflux condenser by means of a ground-glass joint, place 25 ml. of anhydrous *isopropyl* alcohol, 1 ml. of glacial acetic acid, and about 1 milli-mol, accurately weighed, of the sample (*e.g.*, about 0.25 g. of benzoyl peroxide). Warm the solution of the peroxide just to boiling, add 5 ml. of a saturated solution of sodium iodide in *isopropyl* alcohol, and reflux the reaction mixture for 5 minutes. Titrate the resulting solution with standard 0.05*N* sodium thiosulphate to the disappearance of the yellow iodine colour. The end point is usually quite sharp.

Carry out a blank determination on the *isopropyl* alcohol; subtract the volume of thiosulphate solution consumed in the blank from the volume used for the sample.

### CALCULATION

Calculate the percentage purity of the peroxy compound from the expression :

$$\% \text{ Purity} = \frac{V_1 \times N_1 \times M \times 100}{W \times 1000}$$

where  $V_1$  = net volume (ml.) of sodium thiosulphate solution used for sample ;

$N_1$  = normality of sodium thiosulphate solution ;

$M$  = molecular weight of compound ; and

$W$  = weight (g.) of sample.

## XXXIX,7. DETERMINATION OF *iso*THIOCYANATES AND OF *iso*CYANATES

### THEORY

The determination of *isothiocyanates* and of *isocyanates* must be carried out in a non-hydroxylic medium since these compounds react with water and with alcohols. The reaction with a measured excess of a standard solution of *n*-butylamine in dioxan proceeds as follows :

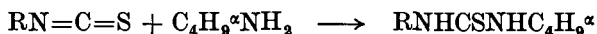

The excess of *n*-butylamine may be titrated, after the reaction is complete, with standard acid : the substituted thioureas and ureas are neutral compounds.

### REAGENTS

*n*-Butylamine in dioxan. Dilute about 2.0 g. of redistilled *n*-butylamine with 100 ml. of purified dioxan.

Sulphuric acid, 0.1N.

Phenolphthalein indicator.

### PROCEDURE

Pipette 25.0 ml. of the *n*-butylamine reagent into a 250 ml. glass-stoppered conical flask (an iodine flask is suitable). Add a weighed sample containing 1 milli-mol of the *isothiocyanate* (e.g., about 0.14 g. of phenyl *isothiocyanate*). Stopper the flask, swirl to dissolve the sample, and allow to stand at room temperature for 15 minutes. Add 20 ml. of distilled water, and titrate the residual *n*-butylamine with standard 0.1N sulphuric acid, using phenolphthalein as indicator.

Run a blank on 25.0 ml. of the reagent, similar in all respects except for the addition of the sample.

## CALCULATION

Calculate the percentage of thiocyanato group from the expression :

$$\% \text{—NCS} = \frac{(V_1 - V_2) \times N_1 \times 58.09 \times 100}{W \times 1000}$$

where  $V_1$  = volume (ml.) of sulphuric acid used for blank ;  
 $V_2$  = volume (ml.) of sulphuric acid used for sample ;  
 $N_1$  = normality of sulphuric acid ; and  
 $W$  = weight (g.) of sample.

**XXXIX.8. DETERMINATION OF  
 CARBOXYLIC ACIDS BY CONVERSION INTO  
 S-BENZYL-*iso*-THIURONIUM SALTS AND  
 TITRATION WITH ACETOUS PERCHLORIC ACID**

## THEORY

The S-benzyl-*iso*-thiuronium salts of carboxylic acids are readily prepared \* but the melting points of many of them lie within a narrow temperature range : furthermore, unless the melting points are determined in every case by the same experimental technique (capillary tube method ; immersion in a liquid bath maintained at a temperature of about 15° below the melting point, followed by heating at a rate of about 4°C per minute) constant values are not always obtained. It is therefore desirable to confirm the identification by an independent method, such as a determination of the equivalent weight of the salt by titration with acetic perchloric acid. The procedure is particularly valuable when the carboxylic acid is not available in the pure state and direct titration with a base is not sufficiently accurate.

The reaction involved in the titration of S-benzyl-*iso*-thiuronium salts with a solution of perchloric acid in acetic acid may be expressed as follows :

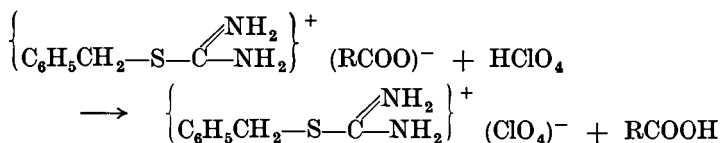

*i.e.*, the titration is essentially that of the carboxylate ion as a base.

## PROCEDURE

Weigh out accurately 0.2–0.3 g. of the S-benzyl-*iso*-thiuronium salt of the carboxylic acid, dissolve it in 15–20 ml. of glacial acetic acid, add 2 drops of crystal violet indicator, and titrate the resulting solution with standard 0.1*N* acetic perchloric acid to a blue-green colour (for preparation of the reagents, see Section XIX,4). The S-benzyl-*iso*-thiuronium picrate may precipitate but this does not affect the titration. Alternatively, determine

\* See *Elementary Practical Organic Chemistry*. Part II. *Qualitative Organic Analysis*, 1957, p. 423.

the end point potentiometrically using the glass - calomel electrode system.

Calculate the equivalent weight of the S-benzyl-*iso*-thiuronium salt (and hence of the carboxylic acid) from the formula :

$$\text{Equivalent weight} = \frac{\text{Weight of S-benzyl-iso-thiuronium salt (g.)} \times 1000}{\text{Volume of acetous perchloric acid (ml.)} \times \text{Normality}}$$

### XXXIX,9. DETERMINATION OF ALCOHOLS BY CONVERSION INTO THE ALKYL XANTHATES AND TITRATION WITH ACETOUS PERCHLORIC ACID OR WITH IODINE

#### THEORY

Potassium alkyl xanthates are readily prepared as crystalline yellow solids \* by the interaction of potassium alkoxides derived from the alcohols and carbon disulphide :

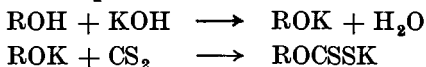

A determination of the equivalent weight of the potassium alkyl xanthate constitutes a method for identifying the alcohol. The procedure is particularly valuable when the alcohol is not anhydrous since alkyl xanthates form in the presence of water.

Two methods may be used for the analysis of the potassium alkyl xanthates :

(a) *Titration with acetous perchloric acid.* The potassium alkyl xanthate is dissolved in acetic acid and titrated with a solution of perchloric acid in the same solvent. The end point may be determined visually using crystal violet indicator (first distinct blue colour) or potentiometrically with the aid of a calomel - glass electrode system.

The reaction would be expected to be :

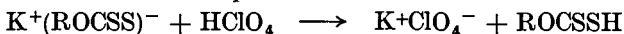

The alkyl xanthates, however, decompose extensively in acetic acid solution :

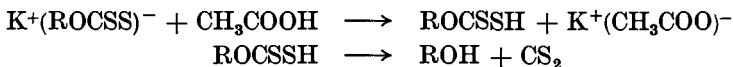

It is therefore highly probable that the reaction is actually the titration of the acetate ion as a base with the acetous perchloric acid :

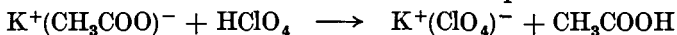

This does not affect the ultimate result since an equivalent quantity of potassium acetate is produced when the xanthate is decomposed. Further support for this view is provided by the experimental fact that the titration curve for potassium ethyl xanthate is almost identical with that for potassium acetate.

\* It may be noted that the mono-alkyl derivatives of ethylene glycol ("cello-solves") also form crystalline xanthates: the latter, indeed, have fairly sharp melting points, e.g., cellosolve, m.p. 185°: methyl cellosolve, m.p. 202°: *n*-butyl cellosolve, m.p. 167°.

(b) *Titration with standard iodine solution.* Aqueous solutions of alkyl xanthates react quantitatively with iodine :

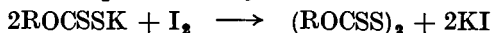

*i.e.*, two mols of potassium alkyl xanthate are equivalent to one mol of iodine. The end point is detected with starch solution in the usual manner.

### PROCEDURE

**Preparation of potassium alkyl xanthates.** Place 1.0 g. of the alcohol and 0.6 g. of A.R. potassium hydroxide in a test-tube and heat gently with constant agitation until the alkali dissolves : solution may take several minutes and, in rare cases, the addition of about 2 drops of water may be necessary. Cool, and add 1.0 ml. of carbon disulphide with vigorous stirring. Continue the stirring with a glass rod for several minutes, add 20 ml. of ether and stir again. Filter off the resulting potassium alkyl xanthate on a small Buchner funnel, and wash it with a few ml. of dry ether. Purify the product by dissolving it in the minimum volume of hot acetone, filter, cool the filtrate in an ice bath, and complete the precipitation by the addition of 20 ml. of dry ether. Filter off the recrystallised solid and wash it with a few ml. of dry ether.

**Titration with acetous perchloric acid.** Weigh out accurately 0.2–0.25 g. of the potassium alkyl xanthate, dissolve it in 20 ml. of glacial acetic acid, add 2 drops of crystal violet indicator, and titrate the solution with standard 0.1*N* acetous perchloric acid (for preparation of reagents, see Section XIX,4) to a distinct blue colour. The colour change at the end point may be checked by potentiometric titration using the glass - calomel electrode system.

Calculate the equivalent weight of the potassium alkyl xanthate (and hence of the alcohol) from the formula :

$$\text{Equivalent weight} = \frac{\text{Weight of potassium alkyl xanthate (g.)} \times 1000}{\text{Volume of acetous perchloric acid (ml.)} \times \text{Normality}}$$

**Titration with standard iodine solution.** Weigh out accurately 0.2–0.25 g. of the purified potassium alkyl xanthate and dissolve it in about 200 ml. of water. Add 2 ml. of one per cent starch solution, and titrate directly with standard 0.1*N* iodine solution, with vigorous shaking, to a distinct blue end point which is permanent for at least 5–10 minutes. As the iodine solution is introduced, a whitish emulsion appears : the latter contains the “dixanthogen” produced in the reaction.

Calculate the equivalent weight of the potassium alkyl xanthate and hence of the alcohol.

#### Note.

If slight decomposition of the potassium alkyl xanthate is suspected, it is recommended that 1 ml. of 10 per cent barium chloride solution be added to the aqueous solution, the mixture thoroughly stirred, and allowed to stand for 1.5–2 hours before titration with the iodine solution.

APPENDIX

A.8.

ATOMIC WEIGHTS

ATOMIC WEIGHTS

Aluminium	Al	26.98	Manganese	Mn	54.93
Antimony	Sb	121.76	Mercury	Hg	200.61
Arsenic	As	74.91	Molybdenum	Mo	95.95
Barium	Ba	137.36	Nickel	Ni	58.69
Beryllium	Be	9.013	Nitrogen	N	14.008
Bismuth	Bi	209.00	Oxygen	O	16.000
Boron	B	10.82	Palladium	Pd	106.7
Bromine	Br	79.916	Phosphorus	P	30.975
Cadmium	Cd	112.41	Platinum	Pt	195.23
Calcium	Ca	40.08	Potassium	K	39.100
Carbon	C	12.011	Selenium	Se	78.96
Cerium	Ce	140.13	Silicon	Si	28.09
Chlorine	Cl	35.457	Silver	Ag	107.880
Chromium	Cr	52.01	Sodium	Na	22.997
Cobalt	Co	58.94	Strontium	Sr	87.63
Copper	Cu	63.54	Sulphur	S	32.066
Fluorine	F	19.00	Tellurium	Te	127.61
Germanium	Ge	72.60	Thorium	Th	232.12
Gold	Au	197.2	Tin	Sn	118.70
Hydrogen	H	1.008	Titanium	Ti	47.90
Iodine	I	126.91	Tungsten	W	183.92
Iron	Fe	55.85	Uranium	U	238.07
Lead	Pb	207.21	Vanadium	V	50.95
Lithium	Li	6.940	Zinc	Zn	65.38
Magnesium	Mg	24.32	Zirconium	Zr	91.22

A.8.



## A.9. REFERENCE WORKS FOR QUANTITATIVE ORGANIC ANALYSIS

In addition to the standard works of reference such as (1) and (2) below, the author suggests that the Departmental Library should contain a representative selection of current text books on Quantitative Organic Analysis. Many of these contain references to the literature.

(1) J. Mitchell *et al.* (editors), *Organic Analysis*. Volumes I, II and III, 1953-1956 (Interscience Publishers).

(2) Houben-Weyl, *Methoden der Organischen Chemie*. Band II. *Analytische Methoden*, Vierte Auflage, 1953 (Georg Thieme Verlag, Stuttgart).

(3) E. P. Clark, *Semimicro Quantitative Organic Analysis*, 1943 (Academic Press).

(4) S. Siggia, *Quantitative Organic Analysis via Functional Groups*, Second Edition, 1954 (J. Wiley; Chapman and Hall).

(5) W. T. Smith and R. L. Shriner, *The Examination of New Organic Compounds: Macro and Semimicro Analytical Methods*, 1956 (J. Wiley; Chapman and Hall).

(6) H. G. Stone, *Determination of Organic Compounds*, 1956 (McGraw-Hill).

(7) F. Wild, *Estimation of Organic Compounds*, 1953 (Cambridge University Press).

(8) J. Mitchell and D. M. Smith, *Aquameyry*, 1948 (Interscience Publishers).

(9) S. J. Clark, *Quantitative Methods of Organic Microanalysis*, 1956 (Butterworths).

(10) R. Belcher and A. L. Godbert, *Semi-Micro Quantitative Organic Analysis*, Second Edition, 1954 (Longmans, Green).

(11) J. B. Niederl and V. Niederl, *Micromethods of Quantitative Organic Analysis*, Second Edition, 1952 (J. Wiley; Chapman and Hall).

(12) R. F. Milton and F. W. Waters, *Methods of Quantitative Micro-Analysis*, Second Edition, 1955 (Edward Arnold).

(13) F. Pregl-J. Grant. *Quantitative Organic Microanalysis*, Fifth Edition, 1951 (Churchill).

(14) R. P. Linstead, J. A. Elvidge and M. Whalley, *A Course in Modern Techniques of Organic Chemistry*, 1955 (Butterworths).

(15) J. S. Fritz and G. S. Hammond, *Quantitative Organic Analysis*, 1957 (J. Wiley; Chapman and Hall).

**A,10. VAPOUR PRESSURE OF WATER AT  
VARIOUS TEMPERATURES  
(IN MM. OF MERCURY)**

TEMP. °C.	PRESSURE	TEMP. °C.	PRESSURE	TEMP. °C.	PRESSURE
5	6·54	15	12·79	25	23·76
6	7·01	16	13·63	26	25·21
7	7·51	17	14·53	27	26·74
8	8·05	18	15·48	28	28·35
9	8·61	19	16·47	29	30·04
10	9·21	20	17·54	30	31·82
11	9·84	21	18·65	31	33·70
12	10·52	22	19·83	32	35·66
13	11·23	23	21·07	33	37·73
14	11·99	24	22·38	34	39·90
				35	42·18

FOUR-FIGURE LOGARITHMS

	0	1	2	3	4	5	6	7	8	9	MEAN DIFFERENCES								
											1	2	3	4	5	6	7	8	9
10	0000	0043	0086	0128	0170	0212	0253	0294	0334	0374	4	8	12	17	21	25	29	33	37
11	0414	0453	0492	0531	0569	0607	0645	0682	0719	0755	4	8	11	15	19	23	26	30	34
12	0792	0828	0864	0899	0934	0969	1004	1038	1072	1106	3	7	10	14	17	21	24	28	31
13	1139	1173	1206	1239	1271	1303	1335	1367	1399	1430	3	6	10	13	16	19	23	26	29
14	1461	1492	1523	1553	1584	1614	1644	1673	1703	1732	3	6	9	12	15	18	21	24	27
15	1761	1790	1818	1847	1875	1903	1931	1959	1987	2014	3	6	8	11	14	17	20	22	25
16	2041	2068	2095	2122	2148	2175	2201	2227	2253	2279	3	5	8	11	13	16	18	21	24
17	2304	2330	2355	2380	2405	2430	2455	2480	2504	2529	2	5	7	10	12	15	17	20	22
18	2553	2577	2601	2625	2648	2672	2695	2718	2742	2765	2	5	7	9	12	14	16	19	21
19	2788	2810	2833	2856	2878	2900	2923	2945	2967	2989	2	4	7	9	11	13	16	18	20
20	3010	3032	3054	3075	3096	3118	3139	3160	3181	3201	2	4	6	8	11	13	15	17	19
21	3222	3243	3263	3284	3304	3324	3345	3365	3385	3404	2	4	6	8	10	12	14	16	18
22	3424	3444	3464	3483	3502	3522	3541	3560	3579	3598	2	4	6	8	10	12	14	15	17
23	3617	3636	3655	3674	3692	3711	3729	3747	3766	3784	2	4	6	7	9	11	13	15	17
24	3802	3820	3838	3856	3874	3892	3909	3927	3945	3962	2	4	5	7	9	11	12	14	16
25	3979	3997	4014	4031	4048	4065	4082	4099	4116	4133	2	3	5	7	9	10	12	14	15
26	4150	4166	4183	4200	4216	4232	4249	4265	4281	4298	2	3	5	7	8	10	11	13	15
27	4314	4330	4346	4362	4378	4393	4409	4425	4440	4456	2	3	5	6	8	9	11	13	14
28	4472	4487	4502	4518	4533	4548	4564	4579	4594	4609	2	3	5	6	8	9	11	12	14
29	4624	4639	4654	4669	4683	4698	4713	4728	4742	4757	1	3	4	6	7	9	10	12	13
30	4771	4786	4800	4814	4829	4843	4857	4871	4886	4900	1	3	4	6	7	9	10	11	13
31	4914	4928	4942	4955	4969	4983	4997	5011	5024	5038	1	3	4	6	7	8	10	11	12
32	5051	5065	5079	5092	5105	5119	5132	5145	5159	5172	1	3	4	5	7	8	9	11	12
33	5185	5198	5211	5224	5237	5250	5263	5276	5289	5302	1	3	4	5	6	8	9	10	12
34	5315	5328	5340	5353	5366	5378	5391	5403	5416	5428	1	3	4	5	6	8	9	10	11
35	5441	5453	5465	5478	5490	5502	5514	5527	5539	5551	1	2	4	5	6	7	9	10	11
36	5563	5575	5587	5599	5611	5623	5635	5647	5658	5670	1	2	4	5	6	7	8	10	11
37	5682	5694	5705	5717	5729	5740	5752	5763	5775	5786	1	2	3	5	6	7	8	9	11
38	5798	5809	5821	5832	5843	5855	5866	5877	5888	5899	1	2	3	5	6	7	8	9	10
39	5911	5922	5933	5944	5955	5966	5977	5988	5999	6010	1	2	3	4	5	7	8	9	10
40	6021	6031	6042	6053	6064	6075	6085	6096	6107	6117	1	2	3	4	5	6	8	9	10
41	6128	6138	6149	6160	6170	6180	6191	6201	6212	6222	1	2	3	4	5	6	7	8	9
42	6232	6243	6253	6263	6274	6284	6294	6304	6314	6325	1	2	3	4	5	6	7	8	9
43	6335	6345	6355	6365	6375	6385	6395	6405	6415	6425	1	2	3	4	5	6	7	8	9
44	6435	6444	6454	6464	6474	6484	6493	6503	6513	6522	1	2	3	4	5	6	7	8	9
45	6532	6542	6551	6561	6571	6580	6590	6599	6609	6618	1	2	3	4	5	6	7	8	9
46	6628	6637	6646	6656	6665	6675	6684	6693	6702	6712	1	2	3	4	5	6	7	7	8
47	6721	6730	6739	6749	6758	6767	6776	6785	6794	6803	1	2	3	4	5	5	6	7	8
48	6812	6821	6830	6839	6848	6857	6866	6875	6884	6893	1	2	3	4	5	5	6	7	8
49	6902	6911	6920	6928	6937	6946	6955	6964	6972	6981	1	2	3	4	4	5	6	7	8
50	6990	6998	7007	7016	7024	7033	7042	7050	7059	7067	1	2	3	3	4	5	6	7	8
51	7076	7084	7093	7101	7110	7118	7126	7135	7143	7152	1	2	3	3	4	5	6	7	8
52	7160	7168	7177	7185	7193	7202	7210	7218	7226	7235	1	2	2	3	4	5	6	7	7
53	7243	7251	7259	7267	7275	7284	7292	7300	7308	7316	1	2	2	3	4	5	6	6	7
54	7324	7332	7340	7348	7356	7364	7372	7380	7388	7396	1	2	2	3	4	5	6	6	7
	0	1	2	3	4	5	6	7	8	9	1	2	3	4	5	6	7	8	9

**FOUR-FIGURE LOGARITHMS**

	0	1	2	3	4	5	6	7	8	9	MEAN DIFFERENCES								
											1	2	3	4	5	6	7	8	9
55	7404	7412	7419	7427	7435	7443	7451	7459	7466	7474	1	2	2	3	4	5	5	6	7
56	7482	7490	7497	7505	7513	7520	7528	7536	7543	7551	1	2	2	3	4	5	5	6	7
57	7559	7566	7574	7582	7589	7597	7604	7612	7619	7627	1	2	2	3	4	5	5	6	7
58	7634	7642	7649	7657	7664	7672	7679	7686	7694	7701	1	1	2	3	4	4	5	6	7
59	7709	7716	7723	7731	7738	7745	7752	7760	7767	7774	1	1	2	3	4	4	5	6	7
60	7782	7789	7796	7803	7810	7818	7825	7832	7839	7846	1	1	2	3	4	4	5	6	6
61	7853	7860	7868	7875	7882	7889	7896	7903	7910	7917	1	1	2	3	4	4	5	6	6
62	7924	7931	7938	7945	7952	7959	7966	7973	7980	7987	1	1	2	3	4	4	5	6	6
63	7993	8000	8007	8014	8021	8028	8035	8041	8048	8055	1	1	2	3	4	4	5	6	6
64	8062	8069	8075	8082	8089	8096	8102	8109	8116	8122	1	1	2	3	4	4	5	6	6
65	8129	8136	8142	8149	8156	8162	8169	8176	8182	8189	1	1	2	3	4	4	5	6	6
66	8195	8202	8209	8215	8222	8228	8235	8241	8248	8254	1	1	2	3	4	4	5	6	6
67	8261	8267	8274	8280	8287	8293	8299	8306	8312	8319	1	1	2	3	4	4	5	6	6
68	8325	8331	8338	8344	8351	8357	8363	8370	8376	8382	1	1	2	3	4	4	5	6	6
69	8388	8395	8401	8407	8414	8420	8426	8432	8439	8445	1	1	2	2	3	4	4	5	6
70	8451	8457	8463	8470	8476	8482	8488	8494	8500	8506	1	1	2	2	3	4	4	5	6
71	8513	8519	8525	8531	8537	8543	8549	8555	8561	8567	1	1	2	2	3	4	4	5	6
72	8573	8579	8585	8591	8597	8603	8609	8615	8621	8627	1	1	2	2	3	4	4	5	6
73	8633	8639	8645	8651	8657	8663	8669	8675	8681	8686	1	1	2	2	3	4	4	5	6
74	8692	8698	8704	8710	8716	8722	8727	8733	8739	8745	1	1	2	2	3	4	4	5	6
75	8751	8756	8762	8768	8774	8779	8785	8791	8797	8802	1	1	2	2	3	4	4	5	6
76	8808	8814	8820	8825	8831	8837	8842	8848	8854	8859	1	1	2	2	3	4	4	5	6
77	8865	8871	8876	8882	8887	8893	8899	8904	8910	8915	1	1	2	2	3	4	4	5	6
78	8921	8927	8932	8938	8943	8949	8954	8960	8965	8971	1	1	2	2	3	4	4	5	6
79	8976	8982	8987	8993	8998	9004	9009	9015	9020	9025	1	1	2	2	3	4	4	5	6
80	9031	9036	9042	9047	9053	9058	9063	9069	9074	9079	1	1	2	2	3	4	4	5	6
81	9085	9090	9096	9101	9106	9112	9117	9122	9128	9133	1	1	2	2	3	4	4	5	6
82	9138	9143	9149	9154	9159	9165	9170	9175	9180	9186	1	1	2	2	3	4	4	5	6
83	9191	9196	9201	9206	9212	9217	9222	9227	9232	9238	1	1	2	2	3	4	4	5	6
84	9243	9248	9253	9258	9263	9269	9274	9279	9284	9289	1	1	2	2	3	4	4	5	6
85	9294	9299	9304	9309	9315	9320	9325	9330	9335	9340	1	1	2	2	3	4	4	5	6
86	9345	9350	9355	9360	9365	9370	9375	9380	9385	9390	1	1	2	2	3	4	4	5	6
87	9395	9400	9405	9410	9415	9420	9425	9430	9435	9440	0	1	1	2	2	3	4	4	4
88	9445	9450	9455	9460	9465	9469	9474	9479	9484	9489	0	1	1	2	2	3	4	4	4
89	9494	9499	9504	9509	9513	9518	9523	9528	9533	9538	0	1	1	2	2	3	4	4	4
90	9542	9547	9552	9557	9562	9566	9571	9576	9581	9586	0	1	1	2	2	3	4	4	4
91	9590	9595	9600	9605	9609	9614	9619	9624	9628	9633	0	1	1	2	2	3	4	4	4
92	9638	9643	9647	9652	9657	9661	9666	9671	9675	9680	0	1	1	2	2	3	4	4	4
93	9685	9689	9694	9699	9703	9708	9713	9717	9722	9727	0	1	1	2	2	3	4	4	4
94	9731	9736	9741	9745	9750	9754	9759	9763	9768	9773	0	1	1	2	2	3	4	4	4
95	9777	9782	9786	9791	9795	9800	9805	9809	9814	9818	0	1	1	2	2	3	4	4	4
96	9823	9827	9832	9836	9841	9845	9850	9854	9859	9863	0	1	1	2	2	3	4	4	4
97	9868	9872	9877	9881	9886	9890	9894	9899	9903	9908	0	1	1	2	2	3	4	4	4
98	9912	9917	9921	9926	9930	9934	9939	9943	9948	9952	0	1	1	2	2	3	4	4	4
99	9956	9961	9965	9969	9974	9978	9983	9987	9991	9996	0	1	1	2	2	3	4	4	4



FIVE-FIGURE LOGARITHMS : 150—200

											PROPORTIONAL PARTS									
	0	1	2	3	4	5	6	7	8	9	1	2	3	4	5	6	7	8	9	
150	17	609	638	667	696	725	754	782	811	840	869	3	6	9	12	14	17	20	23	26
151		898	926	955	984	013	041	070	099	127	156	3	6	9	11	14	17	20	23	26
152	18	184	213	241	270	298	327	355	384	412	441	3	6	9	11	14	17	20	23	25
153		469	498	526	554	583	611	639	667	696	724	3	6	9	11	14	17	20	23	25
154		752	780	808	837	865	893	921	949	977	005	3	6	8	11	14	17	20	23	25
155	19	033	061	089	117	145	173	201	229	257	285	3	6	8	11	14	17	20	22	25
156		312	340	368	396	424	451	479	507	535	562	3	6	8	11	14	17	20	22	25
157		590	618	645	673	700	728	756	783	811	838	3	5	8	11	14	17	19	22	25
158		866	893	921	948	976	003	030	058	085	112	3	5	8	11	14	16	19	22	25
159	20	140	167	194	222	249	276	303	330	358	385	3	5	8	11	14	16	19	22	25
160		412	439	466	493	520	547	575	602	629	656	3	5	8	11	14	16	19	22	24
161		683	710	736	763	790	817	844	871	898	925	3	5	8	11	13	16	19	22	24
162		951	978	005	032	059	085	112	139	165	192	3	5	8	11	13	16	19	21	24
163	21	219	245	272	299	325	352	378	405	431	457	3	5	8	11	13	16	19	21	24
164		484	511	537	564	590	617	643	669	696	722	3	5	8	11	13	16	18	21	24
165		748	775	801	827	854	880	906	932	958	985	3	5	8	10	13	16	18	21	24
166	22	011	037	063	089	115	141	167	194	220	246	3	5	8	10	13	16	18	21	23
167		272	298	324	350	376	401	427	453	479	505	3	5	8	10	13	16	18	21	23
168		531	557	583	608	634	660	686	712	737	763	3	5	8	10	13	15	18	21	23
169		789	814	840	866	891	917	943	968	994	019	3	5	8	10	13	15	18	21	23
170	23	045	070	096	121	147	172	198	223	249	274	3	5	8	10	13	15	18	20	23
171		300	325	350	376	401	426	452	477	502	528	3	5	8	10	13	15	18	20	23
172		553	578	603	629	654	679	704	729	754	779	3	5	8	10	13	15	18	20	23
173		805	830	855	880	905	930	955	980	005	030	2	5	7	10	13	15	18	20	23
174	24	055	080	105	130	155	180	204	229	254	279	2	5	7	10	12	15	17	20	22
175		304	329	353	378	403	428	452	477	502	527	2	5	7	10	12	15	17	20	22
176		551	576	601	625	650	674	699	724	748	773	2	5	7	10	12	15	17	20	22
177		797	822	846	871	895	920	944	969	993	018	2	5	7	10	12	15	17	20	22
178	25	042	066	091	115	139	164	188	212	237	261	2	5	7	10	12	15	17	19	22
179		285	310	334	358	382	406	431	455	479	503	2	5	7	10	12	15	17	19	22
180		527	551	575	600	624	648	672	696	720	744	2	5	7	10	12	14	17	19	22
181		768	792	816	840	864	888	912	935	959	983	2	5	7	10	12	14	17	19	22
182	26	007	031	055	079	102	126	150	174	198	221	2	5	7	10	12	14	17	19	21
183		245	269	293	316	340	364	387	411	435	458	2	5	7	10	12	14	17	19	21
184		482	505	529	553	576	600	623	647	670	694	2	5	7	9	12	14	17	19	21
185		717	741	764	788	811	834	858	881	905	928	2	5	7	9	12	14	16	19	21
186		951	975	998	021	045	068	091	114	138	161	2	5	7	9	12	14	16	19	21
187	27	184	207	231	254	277	300	323	346	370	393	2	5	7	9	12	14	16	19	21
188		416	439	462	485	508	531	554	577	600	623	2	5	7	9	12	14	16	18	21
189		646	669	692	715	738	761	784	807	829	852	2	5	7	9	11	14	16	18	21
190		875	898	921	944	967	989	012	035	058	081	2	5	7	9	11	14	16	18	21
191	28	103	126	149	171	194	217	240	262	285	307	2	5	7	9	11	14	16	18	20
192		330	353	375	398	420	443	466	488	510	533	2	5	7	9	11	14	16	18	20
193		556	578	601	623	646	668	691	713	735	758	2	4	7	9	11	13	16	18	20
194		780	803	825	847	870	892	914	937	959	981	2	4	7	9	11	13	16	18	20
195	29	003	026	048	070	092	115	137	159	181	203	2	4	7	9	11	13	16	18	20
196		226	248	270	292	314	336	358	380	403	425	2	4	7	9	11	13	15	18	20
197		447	469	491	513	535	557	579	601	623	645	2	4	7	9	11	13	15	18	20
198		667	688	710	732	754	776	798	820	842	863	2	4	7	9	11	13	15	18	20
199		885	907	929	951	973	994	016	038	060	081	2	4	7	9	11	13	15	17	20
200	30	103	125	146	168	190	211	233	255	276	298	2	4	7	9	11	13	15	17	20

FIVE-FIGURE LOGARITHMS : 200—250

											PROPORTIONAL PARTS									
	0	1	2	3	4	5	6	7	8	9	1	2	3	4	5	6	7	8	9	
<b>200</b>	30	103	125	146	168	190	211	233	255	276	298	2	4	7	9	11	13	15	17	20
<b>201</b>		320	341	363	384	406	428	449	471	492	514	2	4	6	9	11	13	15	17	19
<b>202</b>		535	557	578	600	621	642	664	685	707	728	2	4	6	9	11	13	15	17	19
<b>203</b>		750	771	792	814	835	856	877	899	920	942	2	4	6	9	11	13	15	17	19
<b>204</b>		963	984	<b>006</b>	<b>027</b>	<b>048</b>	<b>069</b>	<b>091</b>	<b>112</b>	<b>133</b>	<b>154</b>	2	4	6	8	11	13	15	17	19
<b>205</b>	31	175	197	218	239	260	281	302	323	345	366	2	4	6	8	11	13	15	17	19
<b>206</b>		387	408	429	450	471	492	513	534	555	576	2	4	6	8	11	13	15	17	19
<b>207</b>		597	618	639	660	681	702	723	744	765	785	2	4	6	8	10	13	15	17	19
<b>208</b>		806	827	848	869	890	911	931	952	973	994	2	4	6	8	10	13	15	17	19
<b>209</b>	32	015	035	056	077	098	118	139	160	181	201	2	4	6	8	10	12	15	17	19
<b>210</b>		222	243	263	284	305	325	346	366	387	408	2	4	6	8	10	12	14	16	18
<b>211</b>		428	449	469	490	510	531	552	572	593	613	2	4	6	8	10	12	14	16	18
<b>212</b>		634	654	675	695	715	736	756	777	797	818	2	4	6	8	10	12	14	16	18
<b>213</b>		838	858	879	899	919	940	960	980	<b>001</b>	<b>021</b>	2	4	6	8	10	12	14	16	18
<b>214</b>	33	041	062	082	102	122	143	163	183	203	224	2	4	6	8	10	12	14	16	18
<b>215</b>		244	264	284	304	325	345	365	385	405	425	2	4	6	8	10	12	14	16	18
<b>216</b>		445	465	485	506	526	546	566	586	606	626	2	4	6	8	10	12	14	16	18
<b>217</b>		646	666	686	706	726	746	766	786	806	826	2	4	6	8	10	12	14	16	18
<b>218</b>		846	866	885	905	925	945	965	985	<b>005</b>	<b>025</b>	2	4	6	8	10	12	14	16	18
<b>219</b>	34	044	064	084	104	124	143	163	183	203	223	2	4	6	8	10	12	14	16	18
<b>220</b>		242	262	282	301	321	341	361	381	400	420	2	4	6	8	10	12	14	16	18
<b>221</b>		439	459	479	498	518	537	557	577	596	616	2	4	6	8	10	12	14	16	18
<b>222</b>		635	655	674	694	713	733	753	772	792	811	2	4	6	8	10	12	14	16	18
<b>223</b>		830	850	869	889	908	928	947	966	986	<b>005</b>	2	4	6	8	10	12	14	16	18
<b>224</b>	35	025	044	064	083	102	122	141	160	180	199	2	4	6	8	10	12	14	15	17
<b>225</b>		218	238	257	276	295	315	334	353	372	392	2	4	6	8	10	12	14	15	17
<b>226</b>		411	430	449	468	488	507	526	545	564	583	2	4	6	8	10	12	13	15	17
<b>227</b>		603	622	641	660	679	698	717	736	755	774	2	4	6	8	10	11	13	15	17
<b>228</b>		793	813	832	851	870	889	908	927	946	965	2	4	6	8	10	11	13	15	17
<b>229</b>		984	<b>003</b>	<b>021</b>	<b>040</b>	<b>059</b>	<b>078</b>	<b>097</b>	<b>116</b>	<b>135</b>	<b>154</b>	2	4	6	8	9	11	13	15	17
<b>230</b>	36	173	192	211	229	248	267	286	305	324	342	2	4	6	8	9	11	13	15	17
<b>231</b>		361	380	399	418	437	455	474	493	511	530	2	4	6	8	9	11	13	15	17
<b>232</b>		549	568	586	605	624	642	661	680	698	717	2	4	6	7	9	11	13	15	17
<b>233</b>		736	754	773	791	810	829	847	866	884	903	2	4	6	7	9	11	13	15	17
<b>234</b>		922	940	959	977	996	<b>014</b>	<b>033</b>	<b>051</b>	<b>070</b>	<b>088</b>	2	4	6	7	9	11	13	15	17
<b>235</b>	37	107	125	144	162	181	200	218	236	254	273	2	4	6	7	9	11	13	15	17
<b>236</b>		291	310	328	346	365	383	401	420	438	457	2	4	6	7	9	11	13	15	17
<b>237</b>		475	493	511	530	548	566	585	603	621	639	2	4	5	7	9	11	13	15	16
<b>238</b>		658	676	694	712	731	749	767	785	803	822	2	4	5	7	9	11	13	15	16
<b>239</b>		840	858	876	894	912	931	949	967	985	<b>003</b>	2	4	5	7	9	11	13	14	16
<b>240</b>	38	021	039	057	075	093	112	130	148	166	184	2	4	5	7	9	11	13	14	16
<b>241</b>		202	220	238	256	274	292	310	328	346	364	2	4	5	7	9	11	13	14	16
<b>242</b>		382	399	417	435	453	471	489	507	525	543	2	4	5	7	9	11	13	14	16
<b>243</b>		561	578	596	614	632	650	668	686	703	721	2	4	5	7	9	11	12	14	16
<b>244</b>		739	757	775	792	810	828	846	863	881	899	2	4	5	7	9	11	12	14	16
<b>245</b>		917	934	952	970	987	<b>005</b>	<b>023</b>	<b>041</b>	<b>058</b>	<b>076</b>	2	4	5	7	9	11	12	14	16
<b>246</b>	39	094	111	129	146	164	182	199	217	235	252	2	4	5	7	9	11	12	14	16
<b>247</b>		270	287	305	322	340	358	375	393	410	428	2	4	5	7	9	11	12	14	16
<b>248</b>		445	463	480	498	515	533	550	568	585	602	2	3	5	7	9	10	12	14	16
<b>249</b>		620	637	655	672	690	707	724	742	759	777	2	3	5	7	9	10	12	14	16
<b>250</b>		794	811	829	846	863	881	898	915	933	950	2	3	5	7	9	10	12	14	16

FIVE-FIGURE LOGARITHMS : 250-300

											PROPORTIONAL PARTS									
	0	1	2	3	4	5	6	7	8	9	1	2	3	4	5	6	7	8	9	
250	39	794	811	829	846	863	881	898	915	933	950	2	3	5	7	9	10	12	14	16
251		967	985	<b>002</b>	<b>019</b>	<b>037</b>	<b>054</b>	<b>071</b>	<b>088</b>	<b>106</b>	<b>123</b>	2	3	5	7	9	10	12	14	16
252	40	140	157	174	192	209	226	243	261	278	295	2	3	5	7	9	10	12	14	15
253		312	329	346	364	381	398	415	432	449	466	2	3	5	7	9	10	12	14	15
254		483	500	518	535	552	569	586	603	620	637	2	3	5	7	9	10	12	14	15
255		654	671	688	705	722	739	756	773	790	807	2	3	5	7	8	10	12	14	15
256		824	841	858	875	892	909	926	943	959	976	2	3	5	7	8	10	12	14	15
257		993	<b>010</b>	<b>027</b>	<b>044</b>	<b>061</b>	<b>078</b>	<b>095</b>	<b>111</b>	<b>128</b>	<b>145</b>	2	3	5	7	8	10	12	13	15
258	41	162	179	196	212	229	246	263	280	296	313	2	3	5	7	8	10	12	13	15
259		330	347	363	380	397	414	430	447	464	481	2	3	5	7	8	10	12	13	15
260		497	514	531	547	564	581	597	614	631	647	2	3	5	7	8	10	12	13	15
261		664	680	697	714	731	747	764	781	797	814	2	3	5	7	8	10	12	13	15
262		830	847	863	880	896	913	929	946	963	979	2	3	5	7	8	10	12	13	15
263		996	<b>012</b>	<b>029</b>	<b>045</b>	<b>062</b>	<b>078</b>	<b>095</b>	<b>111</b>	<b>127</b>	<b>143</b>	2	3	5	7	8	10	12	13	15
264	42	160	177	193	209	226	243	259	275	292	308	2	3	5	7	8	10	11	13	15
265		325	341	357	374	390	406	423	439	455	472	2	3	5	7	8	10	11	13	15
266		488	504	521	537	553	570	586	602	619	635	2	3	5	7	8	10	11	13	15
267		651	667	684	700	716	732	749	765	781	797	2	3	5	6	8	10	11	13	15
268		813	830	846	862	878	894	910	927	943	959	2	3	5	6	8	10	11	13	15
269		975	991	<b>008</b>	<b>024</b>	<b>040</b>	<b>056</b>	<b>072</b>	<b>088</b>	<b>104</b>	<b>120</b>	2	3	5	6	8	10	11	13	14
270	43	136	152	169	185	201	217	233	249	265	281	2	3	5	6	8	10	11	13	14
271		297	313	329	345	361	377	393	409	425	441	2	3	5	6	8	10	11	13	14
272		457	473	489	505	521	537	553	569	585	600	2	3	5	6	8	10	11	13	14
273		616	632	648	664	680	696	712	727	743	759	2	3	5	6	8	10	11	13	14
274		775	791	807	823	838	854	870	886	902	917	2	3	5	6	8	10	11	13	14
275		933	949	965	981	996	<b>012</b>	<b>028</b>	<b>044</b>	<b>059</b>	<b>075</b>	2	3	5	6	8	9	11	13	14
276	44	091	017	122	138	154	170	185	201	217	232	2	3	5	6	8	9	11	13	14
277		248	264	279	295	311	326	342	358	373	389	2	3	5	6	8	9	11	13	14
278		404	420	436	451	467	483	498	514	529	545	2	3	5	6	8	9	11	12	14
279		560	576	592	607	623	638	654	669	685	700	2	3	5	6	8	9	11	12	14
280		716	731	747	762	778	793	809	824	840	855	2	3	5	6	8	9	11	12	14
281		871	886	902	917	932	948	963	979	994	<b>010</b>	2	3	5	6	8	9	11	12	14
282	45	025	040	056	071	086	102	117	133	148	163	2	3	5	6	8	9	11	12	14
283		179	194	209	225	240	255	271	286	301	317	2	3	5	6	8	9	11	12	14
284		332	347	362	378	393	408	423	439	454	469	2	3	5	6	8	9	11	12	14
285		484	500	515	530	545	560	576	591	606	621	2	3	5	6	8	9	11	12	14
286		637	652	667	682	697	712	728	743	758	773	2	3	5	6	8	9	11	12	14
287		788	803	818	834	849	864	879	894	909	924	2	3	5	6	8	9	11	12	14
288		939	954	969	984	<b>000</b>	<b>015</b>	<b>030</b>	<b>045</b>	<b>060</b>	<b>075</b>	2	3	5	6	8	9	11	12	14
289	46	090	105	120	135	150	165	180	195	210	225	1	3	4	6	8	9	10	12	13
290		240	255	270	285	300	315	330	344	359	374	1	3	4	6	7	9	10	12	13
291		389	404	419	434	449	464	479	494	509	523	1	3	4	6	7	9	10	12	13
292		538	553	568	583	598	613	627	642	657	672	1	3	4	6	7	9	10	12	13
293		687	702	716	731	746	761	776	790	805	820	1	3	4	6	7	9	10	12	13
294		835	849	864	879	894	909	923	938	953	967	1	3	4	6	7	9	10	12	13
295		982	997	<b>012</b>	<b>026</b>	<b>041</b>	<b>056</b>	<b>070</b>	<b>085</b>	<b>100</b>	<b>114</b>	1	3	4	6	7	9	10	12	13
296	47	129	144	159	173	188	202	217	232	246	261	1	3	4	6	7	9	10	12	13
297		276	290	305	319	334	349	363	378	392	407	1	3	4	6	7	9	10	12	13
298		422	436	451	466	480	494	509	524	538	553	1	3	4	6	7	9	10	12	13
299		567	582	596	611	625	640	654	669	683	698	1	3	4	6	7	9	10	12	13
300		712	727	741	756	770	784	799	813	828	842	1	3	4	6	7	9	10	12	13



FIVE-FIGURE LOGARITHMS : 300—350

											PROPORTIONAL PARTS									
	0	1	2	3	4	5	6	7	8	9	1	2	3	4	5	6	7	8	9	
<b>300</b>	47	712	727	741	756	770	784	799	813	828	842	1	3	4	6	7	9	10	12	13
<b>301</b>		857	871	885	900	914	929	943	959	972	986	1	3	4	6	7	9	10	12	13
<b>302</b>	48	001	015	029	044	058	073	087	101	116	130	1	3	4	6	7	9	10	11	13
<b>303</b>		144	159	173	187	202	216	230	244	258	273	1	3	4	6	7	9	10	11	13
<b>304</b>		287	302	316	330	344	359	373	387	401	416	1	3	4	6	7	9	10	11	13
<b>305</b>		430	444	458	473	487	501	515	530	544	558	1	3	4	6	7	9	10	11	13
<b>306</b>		572	586	601	615	629	643	657	671	686	700	1	3	4	6	7	9	10	11	13
<b>307</b>		714	728	742	756	770	785	799	813	827	841	1	3	4	6	7	8	10	11	13
<b>308</b>		855	869	883	887	911	926	940	954	968	982	1	3	4	6	7	8	10	11	13
<b>309</b>		996	010	024	038	058	066	080	094	108	122	1	3	4	6	7	8	10	11	13
<b>310</b>	49	136	150	164	178	192	206	220	234	248	262	1	3	4	6	7	8	10	11	13
<b>311</b>		276	290	304	318	332	346	360	374	388	402	1	3	4	6	7	8	10	11	13
<b>312</b>		415	429	443	457	471	485	499	513	527	541	1	3	4	6	7	8	10	11	13
<b>313</b>		554	568	582	596	610	624	638	651	665	679	1	3	4	6	7	8	10	11	12
<b>314</b>		693	707	721	734	748	762	776	790	803	817	1	3	4	6	7	8	10	11	12
<b>315</b>		831	845	859	872	886	900	914	927	941	955	1	3	4	5	7	8	10	11	12
<b>316</b>		969	983	996	010	024	087	051	065	079	092	1	3	4	5	7	8	10	11	12
<b>317</b>	50	106	119	133	147	161	174	188	202	215	229	1	3	4	5	7	8	10	11	12
<b>318</b>		243	256	270	284	297	311	325	338	352	365	1	3	4	5	7	8	10	11	12
<b>319</b>		379	393	407	420	433	447	461	474	488	501	1	3	4	5	7	8	10	11	12
<b>320</b>		515	529	542	556	569	583	596	610	624	637	1	3	4	5	7	8	9	11	12
<b>321</b>		650	664	678	691	705	718	732	745	759	772	1	3	4	5	7	8	9	11	12
<b>322</b>		786	799	813	826	839	853	866	880	893	907	1	3	4	5	7	8	9	11	12
<b>323</b>		920	934	947	961	974	987	001	014	028	041	1	3	4	5	7	8	9	11	12
<b>324</b>	51	054	068	081	095	108	121	135	148	161	175	1	3	4	5	7	8	9	11	12
<b>325</b>		188	202	215	228	242	255	268	282	295	308	1	3	4	5	7	8	9	11	12
<b>326</b>		322	335	348	362	375	388	402	415	428	442	1	3	4	5	7	8	9	11	12
<b>327</b>		455	468	481	495	508	521	534	548	561	574	1	3	4	5	7	8	9	11	12
<b>328</b>		587	601	614	627	640	654	667	680	693	706	1	3	4	5	7	8	9	11	12
<b>329</b>		720	733	746	759	772	786	799	812	825	838	1	3	4	5	7	8	9	11	12
<b>330</b>		851	865	878	891	904	917	930	943	957	970	1	3	4	5	7	8	9	11	12
<b>331</b>		983	996	009	022	035	048	061	075	088	101	1	3	4	5	7	8	9	10	12
<b>332</b>	52	114	127	140	153	166	179	192	205	218	231	1	3	4	5	7	8	9	10	12
<b>333</b>		244	257	270	284	297	310	323	336	349	362	1	3	4	5	7	8	9	10	12
<b>334</b>		375	388	401	414	427	440	453	466	479	492	1	3	4	5	6	8	9	10	12
<b>335</b>		504	517	530	543	556	569	582	595	608	621	1	3	4	5	6	8	9	10	12
<b>336</b>		634	647	660	673	686	699	711	724	737	750	1	3	4	5	6	8	9	10	12
<b>337</b>		763	776	789	802	815	827	840	853	866	879	1	3	4	5	6	8	9	10	12
<b>338</b>		892	905	917	930	943	956	969	982	994	007	1	3	4	5	6	8	9	10	12
<b>339</b>	53	020	033	046	058	071	084	097	110	122	135	1	3	4	5	6	8	9	10	12
<b>340</b>		148	161	173	186	199	212	224	237	250	263	1	3	4	5	6	8	9	10	11
<b>341</b>		275	288	301	314	326	339	352	364	377	390	1	3	4	5	6	8	9	10	11
<b>342</b>		403	415	428	441	453	466	479	491	504	517	1	3	4	5	6	8	9	10	11
<b>343</b>		529	542	555	567	580	593	605	618	631	643	1	3	4	5	6	8	9	10	11
<b>344</b>		656	668	681	694	706	719	732	744	757	769	1	3	4	5	6	8	9	10	11
<b>345</b>		782	794	807	820	832	845	857	870	882	895	1	3	4	5	6	8	9	10	11
<b>346</b>		908	920	933	945	958	970	983	995	008	020	1	3	4	5	6	8	9	10	11
<b>347</b>	54	033	045	058	070	083	095	108	120	133	145	1	2	4	5	6	8	9	10	11
<b>348</b>		158	170	183	195	208	220	233	245	258	270	1	2	4	5	6	7	9	10	11
<b>349</b>		283	295	308	320	332	345	357	369	382	394	1	2	4	5	6	7	9	10	11
<b>350</b>		407	419	432	444	456	469	481	494	506	518	1	2	4	5	6	7	9	10	11
	0	1	2	3	4	5	6	7	8	9	1	2	3	4	5	6	7	8	9	

FIVE-FIGURE LOGARITHMS : 350—400

											PROPORTIONAL PARTS									
	0	1	2	3	4	5	6	7	8	9	1	2	3	4	5	6	7	8	9	
<b>350</b>	54	407	419	432	444	456	469	481	494	506	518	1	2	4	5	6	7	9	10	11
<b>351</b>		531	543	555	568	580	593	605	617	630	642	1	2	4	5	6	7	9	10	11
<b>352</b>		654	667	679	691	704	716	728	741	753	765	1	2	4	5	6	7	9	10	11
<b>353</b>		777	790	802	814	827	839	851	864	876	888	1	2	4	5	6	7	9	10	11
<b>354</b>		900	913	925	937	949	962	974	986	998	<b>011</b>	1	2	4	5	6	7	9	10	11
<b>355</b>	55	023	035	047	060	072	084	096	108	121	133	1	2	4	5	6	7	9	10	11
<b>356</b>		145	157	169	182	194	206	218	230	242	255	1	2	4	5	6	7	9	10	11
<b>357</b>		267	279	291	303	315	328	340	352	364	376	1	2	4	5	6	7	9	10	11
<b>358</b>		388	400	413	425	437	449	461	473	485	497	1	2	4	5	6	7	8	10	11
<b>359</b>		509	522	534	546	558	570	582	594	606	618	1	2	4	5	6	7	8	10	11
<b>360</b>		630	642	654	666	678	691	703	715	727	739	1	2	4	5	6	7	8	10	11
<b>361</b>		751	763	775	787	799	811	823	835	847	859	1	2	4	5	6	7	8	10	11
<b>362</b>		871	883	895	907	919	931	943	955	967	979	1	2	4	5	6	7	8	10	11
<b>363</b>		991	<b>003</b>	<b>015</b>	<b>027</b>	<b>038</b>	<b>050</b>	<b>062</b>	<b>074</b>	<b>086</b>	<b>098</b>	1	2	4	5	6	7	8	10	11
<b>364</b>	56	110	122	134	146	158	170	182	194	205	217	1	2	4	5	6	7	8	10	11
<b>365</b>		229	241	253	265	277	289	301	312	324	336	1	2	4	5	6	7	8	10	11
<b>366</b>		348	360	372	384	396	409	419	431	443	455	1	2	4	5	6	7	8	9	10
<b>367</b>		467	478	490	502	514	526	538	549	561	573	1	2	4	5	6	7	8	9	10
<b>368</b>		585	597	608	620	632	644	656	667	679	691	1	2	4	5	6	7	8	9	10
<b>369</b>		703	714	726	738	750	761	773	785	797	808	1	2	4	5	6	7	8	9	10
<b>370</b>		820	832	844	855	867	879	891	902	914	926	1	2	4	5	6	7	8	9	10
<b>371</b>		937	949	961	972	984	996	<b>008</b>	<b>019</b>	<b>031</b>	<b>043</b>	1	2	4	5	6	7	8	9	10
<b>372</b>	57	054	066	078	089	101	113	124	136	148	159	1	2	3	5	6	7	8	9	10
<b>373</b>		171	183	194	206	217	229	241	252	264	276	1	2	3	5	6	7	8	9	10
<b>374</b>		287	299	310	322	334	345	357	368	380	392	1	2	3	5	6	7	8	9	10
<b>375</b>		403	415	426	438	449	461	473	484	496	507	1	2	3	5	6	7	8	9	10
<b>376</b>		519	530	542	553	565	576	588	600	611	623	1	2	3	5	6	7	8	9	10
<b>377</b>		634	646	657	669	680	692	703	715	726	738	1	2	3	5	6	7	8	9	10
<b>378</b>		749	761	772	784	795	807	818	830	841	852	1	2	3	5	6	7	8	9	10
<b>379</b>		864	875	887	898	910	921	933	944	955	967	1	2	3	5	6	7	8	9	10
<b>380</b>		978	990	<b>001</b>	<b>013</b>	<b>024</b>	<b>035</b>	<b>047</b>	<b>058</b>	<b>070</b>	<b>081</b>	1	2	3	5	6	7	8	9	10
<b>381</b>	58	092	104	115	127	138	149	161	172	184	195	1	2	3	5	6	7	8	9	10
<b>382</b>		206	218	229	240	252	263	274	286	297	309	1	2	3	5	6	7	8	9	10
<b>383</b>		320	331	343	354	365	377	388	399	410	422	1	2	3	5	6	7	8	9	10
<b>384</b>		433	444	456	467	478	490	501	512	524	535	1	2	3	5	6	7	8	9	10
<b>385</b>		545	557	569	580	591	602	614	625	636	647	1	2	3	4	6	7	8	9	10
<b>386</b>		659	670	681	692	704	715	726	737	749	760	1	2	3	4	6	7	8	9	10
<b>387</b>		771	782	794	805	816	827	838	850	861	872	1	2	3	4	6	7	8	9	10
<b>388</b>		883	894	906	917	928	939	950	961	973	984	1	2	3	4	6	7	8	9	10
<b>389</b>		995	<b>006</b>	<b>017</b>	<b>028</b>	<b>040</b>	<b>051</b>	<b>062</b>	<b>073</b>	<b>084</b>	<b>095</b>	1	2	3	4	6	7	8	9	10
<b>390</b>	59	106	118	129	140	151	162	173	184	195	207	1	2	3	4	6	7	8	9	10
<b>391</b>		218	229	240	251	262	273	284	295	306	318	1	2	3	4	6	7	8	9	10
<b>392</b>		329	340	351	362	373	384	395	406	417	428	1	2	3	4	6	7	8	9	10
<b>393</b>		439	450	461	472	483	494	506	517	528	539	1	2	3	4	6	7	8	9	10
<b>394</b>		550	561	572	583	594	605	616	627	638	649	1	2	3	4	5	7	8	9	10
<b>395</b>		660	671	682	693	704	715	726	737	748	759	1	2	3	4	5	7	8	9	10
<b>396</b>		770	780	791	802	813	824	835	846	857	868	1	2	3	4	5	7	8	9	10
<b>397</b>		879	890	901	912	923	934	945	956	966	977	1	2	3	4	5	7	8	9	10
<b>398</b>		988	999	<b>010</b>	<b>021</b>	<b>032</b>	<b>043</b>	<b>054</b>	<b>065</b>	<b>076</b>	<b>086</b>	1	2	3	4	5	7	8	9	10
<b>399</b>	60	097	108	119	130	141	152	163	173	184	195	1	2	3	4	5	7	8	9	10
<b>400</b>		206	217	228	239	249	260	271	282	293	304	1	2	3	4	5	7	8	9	10
	0	1	2	3	4	5	6	7	8	9	1	2	3	4	5	6	7	8	9	

FIVE-FIGURE LOGARITHMS : 400—450

											PROPORTIONAL PARTS									
	0	1	2	3	4	5	6	7	8	9	1	2	3	4	5	6	7	8	9	
400	60	206	217	228	239	249	260	271	282	293	304	1	2	3	4	5	7	8	9	10
401		314	325	336	347	358	369	379	390	401	412	1	2	3	4	5	6	8	9	10
402		423	433	444	455	466	477	487	498	509	520	1	2	3	4	5	6	8	9	10
403		530	541	552	563	574	584	595	606	617	627	1	2	3	4	5	6	8	9	10
404		638	649	660	670	681	692	703	713	724	735	1	2	3	4	5	6	8	9	10
405		745	756	767	778	788	799	810	820	831	842	1	2	3	4	5	6	7	9	10
406		853	863	874	885	895	906	917	927	938	949	1	2	3	4	5	6	7	9	10
407		959	970	981	991	002	013	023	034	045	055	1	2	3	4	5	6	7	9	10
408	61	066	077	087	098	109	119	130	140	151	162	1	2	3	4	5	6	7	9	10
409		172	183	194	204	215	225	236	247	257	268	1	2	3	4	5	6	7	8	10
410		278	289	299	310	321	331	342	352	363	374	1	2	3	4	5	6	7	8	10
411		384	395	405	416	426	437	448	458	469	479	1	2	3	4	5	6	7	8	10
412		490	500	511	521	532	542	553	563	574	584	1	2	3	4	5	6	7	8	9
413		595	606	616	627	637	648	658	669	679	690	1	2	3	4	5	6	7	8	9
414		700	711	721	732	742	752	763	773	784	794	1	2	3	4	5	6	7	8	9
415		805	815	826	836	847	857	868	878	888	899	1	2	3	4	5	6	7	8	9
416		909	920	930	941	951	961	972	982	993	003	1	2	3	4	5	6	7	8	9
417	62	014	024	034	045	055	065	076	086	097	107	1	2	3	4	5	6	7	8	9
418		118	128	138	149	159	170	180	190	201	211	1	2	3	4	5	6	7	8	9
419		221	232	242	252	263	273	284	294	304	315	1	2	3	4	5	6	7	8	9
420		325	335	346	356	366	377	387	397	408	418	1	2	3	4	5	6	7	8	9
421		428	439	449	459	469	480	490	500	511	521	1	2	3	4	5	6	7	8	9
422		531	542	552	562	572	583	593	603	613	624	1	2	3	4	5	6	7	8	9
423		634	644	655	665	675	685	696	706	716	726	1	2	3	4	5	6	7	8	9
424		737	747	757	767	778	788	798	808	818	829	1	2	3	4	5	6	7	8	9
425		839	849	859	870	880	890	900	910	921	931	1	2	3	4	5	6	7	8	9
426		941	951	961	972	982	992	002	012	022	033	1	2	3	4	5	6	7	8	9
427	63	043	053	063	073	083	094	104	114	124	134	1	2	3	4	5	6	7	8	9
428		144	155	165	175	185	195	205	215	225	236	1	2	3	4	5	6	7	8	9
429		246	256	266	276	286	296	306	317	327	337	1	2	3	4	5	6	7	8	9
430		347	357	367	377	387	397	407	417	428	438	1	2	3	4	5	6	7	8	9
431		448	458	468	478	488	498	508	518	528	538	1	2	3	4	5	6	7	8	9
432		548	558	568	579	589	599	609	619	629	639	1	2	3	4	5	6	7	8	9
433		649	659	669	679	689	699	709	719	729	739	1	2	3	4	5	6	7	8	9
434		749	759	769	779	789	799	809	819	829	839	1	2	3	4	5	6	7	8	9
435		849	859	869	879	889	899	909	919	929	939	1	2	3	4	5	6	7	8	9
436		949	959	969	979	988	998	008	018	028	038	1	2	3	4	5	6	7	8	9
437	64	048	058	068	078	088	098	108	118	128	137	1	2	3	4	5	6	7	8	9
438		147	157	167	177	187	197	207	217	227	237	1	2	3	4	5	6	7	8	9
439		246	256	266	276	286	296	306	316	326	335	1	2	3	4	5	6	7	8	9
440		345	355	365	375	385	395	404	414	424	434	1	2	3	4	5	6	7	8	9
441		444	454	464	473	483	493	503	513	523	532	1	2	3	4	5	6	7	8	9
442		542	552	562	572	582	591	601	611	621	631	1	2	3	4	5	6	7	8	9
443		640	650	660	670	680	689	699	709	719	729	1	2	3	4	5	6	7	8	9
444		738	748	758	768	777	787	797	807	816	826	1	2	3	4	5	6	7	8	9
445		836	846	856	865	875	885	895	904	914	924	1	2	3	4	5	6	7	8	9
446		933	943	953	963	972	982	992	002	011	021	1	2	3	4	5	6	7	8	9
447	65	031	040	050	060	070	079	089	099	108	118	1	2	3	4	5	6	7	8	9
448		128	137	147	157	167	176	186	196	205	215	1	2	3	4	5	6	7	8	9
449		225	234	244	254	263	273	283	292	302	312	1	2	3	4	5	6	7	8	9
450		321	331	341	350	360	369	379	388	398	408	1	2	3	4	5	6	7	8	9



FIVE-FIGURE LOGARITHMS : 500—550

											PROPORTIONAL PARTS									
	0	1	2	3	4	5	6	7	8	9	1	2	3	4	5	6	7	8	9	
500	69	897	906	914	923	932	940	949	958	966	975	1	2	3	3	4	5	6	7	8
501		984	992	001	010	018	027	036	044	053	062	1	2	3	3	4	5	6	7	8
502	70	070	079	088	096	105	114	122	131	140	148	1	2	3	3	4	5	6	7	8
503		157	165	174	183	191	200	209	217	226	234	1	2	3	3	4	5	6	7	8
504		243	252	260	269	278	286	295	303	312	321	1	2	3	3	4	5	6	7	8
505		329	338	346	355	364	372	381	389	398	406	1	2	3	3	4	5	6	7	8
506		415	424	432	441	449	458	467	475	484	492	1	2	3	3	4	5	6	7	8
507		501	509	518	526	535	544	552	561	569	578	1	2	3	3	4	5	6	7	8
508		586	595	603	612	621	629	638	646	655	663	1	2	3	3	4	5	6	7	8
509		672	680	689	697	706	714	723	731	740	748	1	2	3	3	4	5	6	7	8
510		757	766	774	783	791	800	808	817	825	834	1	2	3	3	4	5	6	7	8
511		842	851	859	868	876	885	893	902	910	919	1	2	3	3	4	5	6	7	8
512		927	935	944	952	961	969	978	986	995	003	1	2	3	3	4	5	6	7	8
513	71	012	020	029	037	046	054	062	071	079	088	1	2	3	3	4	5	6	7	8
514		096	105	113	122	130	139	147	155	164	172	1	2	3	3	4	5	6	7	8
515		181	189	198	206	214	223	231	240	248	257	1	2	3	3	4	5	6	7	8
516		265	273	282	290	299	307	315	324	332	341	1	2	3	3	4	5	6	7	8
517		349	357	366	374	383	391	399	408	416	425	1	2	3	3	4	5	6	7	8
518		433	441	450	458	466	475	483	492	500	508	1	2	3	3	4	5	6	7	8
519		517	525	533	542	550	559	567	575	584	592	1	2	2	3	4	5	6	7	8
520		600	609	617	625	634	642	650	659	667	675	1	2	2	3	4	5	6	7	8
521		684	692	700	709	717	725	734	742	750	759	1	2	2	3	4	5	6	7	8
522		767	775	784	792	800	809	817	825	834	842	1	2	2	3	4	5	6	7	7
523		850	858	867	875	883	892	900	908	917	925	1	2	2	3	4	5	6	7	7
524		933	941	950	958	966	975	983	991	999	008	1	2	2	3	4	5	6	7	7
525	72	016	024	032	041	049	057	066	074	082	090	1	2	2	3	4	5	6	7	7
526		099	107	115	123	132	140	148	156	165	173	1	2	2	3	4	5	6	7	7
527		181	189	198	206	214	222	230	239	247	255	1	2	2	3	4	5	6	7	7
528		263	272	280	288	296	304	313	321	329	337	1	2	2	3	4	5	6	7	7
529		346	354	362	370	378	387	395	403	411	419	1	2	2	3	4	5	6	7	7
530		428	436	444	452	460	469	477	485	493	501	1	2	2	3	4	5	6	7	7
531		509	518	526	534	542	550	558	567	575	583	1	2	2	3	4	5	6	7	7
532		591	599	607	616	624	632	640	648	656	665	1	2	2	3	4	5	6	7	7
533		673	681	689	697	705	713	722	730	738	746	1	2	2	3	4	5	6	7	7
534		754	762	770	779	787	795	803	811	819	827	1	2	2	3	4	5	6	6	7
535		835	843	852	860	868	876	884	892	900	908	1	2	2	3	4	5	6	6	7
536		916	925	933	941	949	957	965	973	981	989	1	2	2	3	4	5	6	6	7
537		997	006	014	022	030	038	046	054	062	070	1	2	2	3	4	5	6	6	7
538	73	078	086	094	102	111	119	127	135	143	151	1	2	2	3	4	5	6	6	7
539		159	167	175	183	191	199	207	215	223	231	1	2	2	3	4	5	6	6	7
540		239	247	255	264	272	280	288	296	304	312	1	2	2	3	4	5	6	6	7
541		320	328	336	344	352	360	368	376	384	392	1	2	2	3	4	5	6	6	7
542		400	408	416	424	432	440	448	456	464	472	1	2	2	3	4	5	6	6	7
543		480	488	496	504	512	520	528	536	544	552	1	2	2	3	4	5	6	6	7
544		560	568	576	584	592	600	608	616	624	632	1	2	2	3	4	5	6	6	7
545		640	648	656	664	672	679	687	695	703	711	1	2	2	3	4	5	6	6	7
546		719	727	735	743	751	759	767	775	783	791	1	2	2	3	4	5	6	6	7
547		799	807	815	823	830	838	846	854	862	870	1	2	2	3	4	5	6	6	7
548		878	886	894	902	910	918	926	933	941	949	1	2	2	3	4	5	6	6	7
549		957	965	973	981	989	997	005	013	020	028	1	2	2	3	4	5	6	6	7
550	74	036	044	052	060	068	076	084	092	099	107	1	2	2	3	4	5	6	6	7

FIVE-FIGURE LOGARITHMS : 550—600

											PROPORTIONAL PARTS									
	0	1	2	3	4	5	6	7	8	9	1	2	3	4	5	6	7	8	9	
<b>550</b>	74	036	044	052	060	068	076	084	092	099	107	1	2	2	3	4	5	6	6	7
<b>551</b>		115	123	131	139	147	155	162	170	178	186	1	2	2	3	4	5	6	6	7
<b>552</b>		194	202	210	218	225	233	241	249	257	265	1	2	2	3	4	5	6	6	7
<b>553</b>		273	280	288	296	304	312	320	327	335	343	1	2	2	3	4	5	5	6	7
<b>554</b>		351	359	367	374	382	390	398	406	414	421	1	2	2	3	4	5	5	6	7
<b>555</b>		429	437	445	453	461	468	476	484	492	500	1	2	2	3	4	5	5	6	7
<b>556</b>		507	515	523	531	539	547	554	562	570	578	1	2	2	3	4	5	5	6	7
<b>557</b>		586	593	601	609	617	624	632	640	648	656	1	2	2	3	4	5	5	6	7
<b>558</b>		663	671	679	687	695	702	710	718	726	733	1	2	2	3	4	5	5	6	7
<b>559</b>		741	749	757	764	772	780	788	796	803	811	1	2	2	3	4	5	5	6	7
<b>560</b>		819	827	834	842	850	858	865	873	881	889	1	2	2	3	4	5	5	6	7
<b>561</b>		896	904	912	920	927	935	943	950	958	966	1	2	2	3	4	5	5	6	7
<b>562</b>		974	981	989	997	<b>005</b>	<b>012</b>	<b>020</b>	<b>028</b>	<b>035</b>	<b>043</b>	1	2	2	3	4	5	5	6	7
<b>563</b>	75	051	059	066	074	082	089	097	105	113	120	1	2	2	3	4	5	5	6	7
<b>564</b>		128	136	143	151	159	166	174	182	189	197	1	2	2	3	4	5	5	6	7
<b>565</b>		205	213	220	228	236	243	251	259	266	274	1	2	2	3	4	5	5	6	7
<b>566</b>		282	289	297	305	312	320	328	335	343	351	1	2	2	3	4	5	5	6	7
<b>567</b>		358	366	374	381	389	397	404	412	420	427	1	2	2	3	4	5	5	6	7
<b>568</b>		435	442	450	458	465	473	481	488	496	504	1	2	2	3	4	5	5	6	7
<b>569</b>		511	519	526	534	542	549	557	565	572	580	1	2	2	3	4	5	5	6	7
<b>570</b>		587	595	603	610	618	626	633	641	648	656	1	2	2	3	4	5	5	6	7
<b>571</b>		664	671	679	686	694	702	709	717	724	732	1	2	2	3	4	5	5	6	7
<b>572</b>		740	747	755	762	770	778	785	793	800	808	1	2	2	3	4	5	5	6	7
<b>573</b>		815	823	831	838	846	853	861	868	876	884	1	2	2	3	4	5	5	6	7
<b>574</b>		891	899	906	914	921	929	937	944	952	959	1	2	2	3	4	5	5	6	7
<b>575</b>		967	974	982	989	997	<b>005</b>	<b>012</b>	<b>020</b>	<b>027</b>	<b>035</b>	1	2	2	3	4	5	5	6	7
<b>576</b>	76	042	050	057	065	072	080	087	095	103	110	1	2	2	3	4	5	5	6	7
<b>577</b>		118	125	133	140	148	155	163	170	178	185	1	2	2	3	4	5	5	6	7
<b>578</b>		193	200	208	215	223	230	238	245	253	260	1	2	2	3	4	5	5	6	7
<b>579</b>		268	275	283	290	298	305	313	320	328	335	1	2	2	3	4	5	5	6	7
<b>580</b>		343	350	358	365	373	380	388	395	403	410	1	2	2	3	4	4	5	6	7
<b>581</b>		418	425	433	440	448	455	462	470	477	485	1	2	2	3	4	4	5	6	7
<b>582</b>		492	500	507	515	522	530	537	544	552	559	1	1	2	3	4	4	5	6	7
<b>583</b>		567	574	582	589	597	604	612	619	626	634	1	1	2	3	4	4	5	6	7
<b>584</b>		641	649	656	664	671	678	686	693	701	708	1	1	2	3	4	4	5	6	7
<b>585</b>		716	723	730	738	745	753	760	768	775	782	1	1	2	3	4	4	5	6	7
<b>586</b>		790	797	805	812	819	827	834	842	849	856	1	1	2	3	4	4	5	6	7
<b>587</b>		864	871	879	886	893	901	908	916	923	930	1	1	2	3	4	4	5	6	7
<b>588</b>		938	945	952	960	967	975	982	989	997	<b>004</b>	1	1	2	3	4	4	5	6	7
<b>589</b>	77	012	019	026	034	041	048	056	063	070	078	1	1	2	3	4	4	5	6	7
<b>590</b>		085	093	100	107	115	122	129	137	144	151	1	1	2	3	4	4	5	6	7
<b>591</b>		159	166	173	181	188	195	203	210	218	225	1	1	2	3	4	4	5	6	7
<b>592</b>		232	240	247	254	262	269	276	283	291	298	1	1	2	3	4	4	5	6	7
<b>593</b>		305	313	320	327	335	342	349	357	364	371	1	1	2	3	4	4	5	6	7
<b>594</b>		379	386	393	401	408	415	422	430	437	444	1	1	2	3	4	4	5	6	7
<b>595</b>		452	459	466	474	481	488	495	503	510	517	1	1	2	3	4	4	5	6	7
<b>596</b>		525	532	539	546	554	561	568	576	583	590	1	1	2	3	4	4	5	6	7
<b>597</b>		597	605	612	619	627	634	641	648	656	663	1	1	2	3	4	4	5	6	7
<b>598</b>		670	677	685	692	699	706	714	721	728	735	1	1	2	3	4	4	5	6	7
<b>599</b>		743	750	757	764	772	779	786	793	801	808	1	1	2	3	4	4	5	6	7
<b>600</b>		815	822	830	837	844	851	859	866	875	880	1	1	2	3	4	4	5	6	7
		0	1	2	3	4	5	6	7	8	9	1	2	3	4	5	6	7	8	9

FIVE-FIGURE LOGARITHMS : 600—650

											PROPORTIONAL PARTS									
	0	1	2	3	4	5	6	7	8	9	1	2	3	4	5	6	7	8	9	
<b>600</b>	77	815	822	830	837	844	851	859	866	873	880	1	1	2	3	4	4	5	6	7
<b>601</b>		887	895	902	909	916	924	931	938	945	952	1	1	2	3	4	4	5	6	7
<b>602</b>		960	967	974	981	988	996	<b>003 010 017 024</b>				1	1	2	3	4	4	5	6	6
<b>603</b>	78	032	039	046	053	061	068	075	082	089	096	1	1	2	3	4	4	5	6	6
<b>604</b>		104	111	118	125	132	140	147	154	161	168	1	1	2	3	4	4	5	6	6
<b>605</b>		176	183	190	197	204	211	219	226	233	240	1	1	2	3	4	4	5	6	6
<b>606</b>		247	254	262	269	276	283	290	297	305	312	1	1	2	3	4	4	5	6	6
<b>607</b>		319	326	333	340	347	355	362	369	376	383	1	1	2	3	4	4	5	6	6
<b>608</b>		390	398	405	412	419	426	433	440	447	455	1	1	2	3	4	4	5	6	6
<b>609</b>		462	469	476	483	490	497	504	512	519	526	1	1	2	3	4	4	5	6	6
<b>610</b>		533	540	547	554	561	569	576	583	590	597	1	1	2	3	4	4	5	6	6
<b>611</b>		604	611	618	625	633	640	647	654	661	668	1	1	2	3	4	4	5	6	6
<b>612</b>		675	682	689	696	704	711	718	725	732	739	1	1	2	3	4	4	5	6	6
<b>613</b>		746	753	760	767	774	781	789	796	803	810	1	1	2	3	4	4	5	6	6
<b>614</b>		817	824	831	838	845	852	859	866	873	880	1	1	2	3	4	4	5	6	6
<b>615</b>		888	895	902	909	916	923	930	937	944	951	1	1	2	3	4	4	5	6	6
<b>616</b>		958	965	972	979	986	993	<b>000 007 014 021</b>				1	1	2	3	4	4	5	6	6
<b>617</b>	79	029	036	043	050	057	064	071	078	085	092	1	1	2	3	4	4	5	6	6
<b>618</b>		099	106	113	120	127	134	141	148	155	162	1	1	2	3	4	4	5	6	6
<b>619</b>		169	176	183	190	197	204	211	218	225	232	1	1	2	3	4	4	5	6	6
<b>620</b>		239	246	253	260	267	274	281	288	295	302	1	1	2	3	4	4	5	6	6
<b>621</b>		309	316	323	330	337	344	351	358	365	372	1	1	2	3	4	4	5	6	6
<b>622</b>		379	386	393	400	407	414	421	428	435	442	1	1	2	3	4	4	5	6	6
<b>623</b>		449	456	463	470	477	484	491	498	505	512	1	1	2	3	3	4	5	6	6
<b>624</b>		518	525	532	539	546	553	560	567	574	581	1	1	2	3	3	4	5	6	6
<b>625</b>		588	595	602	609	616	623	630	637	644	650	1	1	2	3	3	4	5	6	6
<b>626</b>		657	664	671	678	685	692	699	706	713	720	1	1	2	3	3	4	5	6	6
<b>627</b>		727	734	741	748	754	761	768	775	782	789	1	1	2	3	3	4	5	6	6
<b>628</b>		796	803	810	817	824	831	837	844	851	858	1	1	2	3	3	4	5	6	6
<b>629</b>		865	872	879	886	893	900	906	913	920	927	1	1	2	3	3	4	5	6	6
<b>630</b>		934	941	948	955	962	969	975	982	989	996	1	1	2	3	3	4	5	6	6
<b>631</b>	80	003	010	017	024	030	037	044	051	058	065	1	1	2	3	3	4	5	6	6
<b>632</b>		072	079	085	092	099	106	113	120	127	134	1	1	2	3	3	4	5	6	6
<b>633</b>		140	147	154	161	168	175	182	188	195	202	1	1	2	3	3	4	5	6	6
<b>634</b>		209	216	223	229	236	243	250	257	264	271	1	1	2	3	3	4	5	6	6
<b>635</b>		277	284	291	298	305	312	318	325	332	339	1	1	2	3	3	4	5	6	6
<b>636</b>		346	353	359	366	373	380	387	393	400	407	1	1	2	3	3	4	5	6	6
<b>637</b>		414	421	428	434	441	448	455	462	468	475	1	1	2	3	3	4	5	6	6
<b>638</b>		482	489	496	502	509	516	523	530	536	543	1	1	2	3	3	4	5	6	6
<b>639</b>		550	557	564	570	577	584	591	598	604	611	1	1	2	3	3	4	5	6	6
<b>640</b>		618	625	632	638	645	652	659	665	672	679	1	1	2	3	3	4	5	6	6
<b>641</b>		686	693	699	706	713	720	726	733	740	747	1	1	2	3	3	4	5	6	6
<b>642</b>		754	760	767	774	781	787	794	801	808	814	1	1	2	3	3	4	5	6	6
<b>643</b>		821	828	835	841	848	855	862	868	875	882	1	1	2	3	3	4	5	6	6
<b>644</b>		889	895	902	909	916	922	929	936	942	949	1	1	2	3	3	4	5	6	6
<b>645</b>		956	963	969	976	983	990	996	<b>003 010 017</b>			1	1	2	3	3	4	5	6	6
<b>646</b>	81	023	030	037	043	050	057	064	070	077	084	1	1	2	3	3	4	5	6	6
<b>647</b>		090	097	104	111	117	124	131	137	144	151	1	1	2	3	3	4	5	6	6
<b>648</b>		158	164	171	178	184	191	198	204	211	218	1	1	2	3	3	4	5	6	6
<b>649</b>		224	231	238	245	251	258	265	271	278	285	1	1	2	3	3	4	5	6	6
<b>650</b>		291	298	305	311	318	325	331	338	345	351	1	1	2	3	3	4	5	6	6

FIVE-FIGURE LOGARITHMS : 650—700

											PROPORTIONAL PARTS									
	0	1	2	3	4	5	6	7	8	9	1	2	3	4	5	6	7	8	9	
<b>650</b>	81	291	298	305	311	318	325	331	338	345	351	1	1	2	3	3	4	5	5	6
<b>651</b>		358	365	371	378	385	391	398	405	411	418	1	1	2	3	3	4	5	5	6
<b>652</b>		425	431	438	445	451	458	465	471	478	485	1	1	2	3	3	4	5	5	6
<b>653</b>		491	498	505	511	518	525	531	538	544	551	1	1	2	3	3	4	5	5	6
<b>654</b>		558	564	571	578	584	591	598	604	611	618	1	1	2	3	3	4	5	5	6
<b>655</b>		624	631	637	644	651	657	664	671	677	684	1	1	2	3	3	4	5	5	6
<b>656</b>		690	697	704	710	717	723	730	737	743	750	1	1	2	3	3	4	5	5	6
<b>657</b>		757	763	770	776	783	790	796	803	809	816	1	1	2	3	3	4	5	5	6
<b>658</b>		823	829	836	842	849	856	862	869	875	882	1	1	2	3	3	4	5	5	6
<b>659</b>		889	895	902	908	915	921	928	935	941	948	1	1	2	3	3	4	5	5	6
<b>660</b>		954	961	968	974	981	987	994	<b>000</b>	<b>007</b>	<b>014</b>	1	1	2	3	3	4	5	5	6
<b>661</b>	82	020	027	033	040	046	053	060	066	073	079	1	1	2	3	3	4	5	5	6
<b>662</b>		086	092	099	105	112	119	125	132	138	145	1	1	2	3	3	4	5	5	6
<b>663</b>		151	158	164	171	177	184	191	197	204	210	1	1	2	3	3	4	5	5	6
<b>664</b>		217	223	230	236	243	250	256	263	269	276	1	1	2	3	3	4	5	5	6
<b>665</b>		282	289	295	302	308	315	321	328	334	341	1	1	2	3	3	4	5	5	6
<b>666</b>		347	354	360	367	374	380	387	393	400	406	1	1	2	3	3	4	5	5	6
<b>667</b>		413	419	426	432	439	445	452	458	465	471	1	1	2	3	3	4	5	5	6
<b>668</b>		478	484	491	497	504	510	517	523	530	536	1	1	2	3	3	4	5	5	6
<b>669</b>		543	549	556	562	569	575	582	588	595	601	1	1	2	3	3	4	5	5	6
<b>670</b>		607	614	620	627	633	640	646	653	659	666	1	1	2	3	3	4	5	5	6
<b>671</b>		672	679	685	692	698	705	711	718	724	730	1	1	2	3	3	4	5	5	6
<b>672</b>		737	743	750	756	763	769	776	782	789	795	1	1	2	3	3	4	5	5	6
<b>673</b>		802	808	814	821	827	834	840	847	853	860	1	1	2	3	3	4	5	5	6
<b>674</b>		866	872	879	885	892	898	905	911	918	924	1	1	2	3	3	4	4	5	6
<b>675</b>		930	937	943	950	956	963	969	975	982	988	1	1	2	3	3	4	4	5	6
<b>676</b>		995	<b>001</b>	<b>008</b>	<b>014</b>	<b>020</b>	<b>027</b>	<b>033</b>	<b>040</b>	<b>046</b>	<b>052</b>	1	1	2	3	3	4	4	5	6
<b>677</b>	83	059	065	072	078	085	091	097	104	110	117	1	1	2	3	3	4	4	5	6
<b>678</b>		123	129	136	142	149	155	161	168	174	181	1	1	2	3	3	4	4	5	6
<b>679</b>		187	193	200	206	213	219	225	232	238	244	1	1	2	3	3	4	4	5	6
<b>680</b>		251	257	264	270	276	283	289	296	302	308	1	1	2	3	3	4	4	5	6
<b>681</b>		315	321	327	334	340	347	353	359	366	372	1	1	2	3	3	4	4	5	6
<b>682</b>		378	385	391	398	404	410	417	423	429	436	1	1	2	3	3	4	4	5	6
<b>683</b>		442	448	455	461	468	474	480	487	493	499	1	1	2	3	3	4	4	5	6
<b>684</b>		506	512	518	525	531	537	544	550	556	563	1	1	2	3	3	4	4	5	6
<b>685</b>		569	575	582	588	594	601	607	613	620	626	1	1	2	3	3	4	4	5	6
<b>686</b>		632	639	645	651	658	664	670	677	683	689	1	1	2	3	3	4	4	5	6
<b>687</b>		696	702	708	715	721	727	734	740	746	753	1	1	2	3	3	4	4	5	6
<b>688</b>		759	765	771	778	784	790	797	803	809	816	1	1	2	3	3	4	4	5	6
<b>689</b>		822	828	835	841	847	853	860	866	872	879	1	1	2	3	3	4	4	5	6
<b>690</b>		885	891	898	904	910	916	923	929	935	942	1	1	2	3	3	4	4	5	6
<b>691</b>		948	954	960	967	973	979	986	992	998	<b>004</b>	1	1	2	3	3	4	4	5	6
<b>692</b>	84	011	017	023	029	036	042	048	055	061	067	1	1	2	3	3	4	4	5	6
<b>693</b>		073	080	086	092	098	105	111	117	123	130	1	1	2	2	3	4	4	5	6
<b>694</b>		136	142	148	155	161	167	173	180	186	192	1	1	2	2	3	4	4	5	6
<b>695</b>		198	205	211	217	223	230	236	242	248	255	1	1	2	2	3	4	4	5	6
<b>696</b>		261	267	273	280	286	292	298	305	311	317	1	1	2	2	3	4	4	5	6
<b>697</b>		323	330	336	342	348	354	361	367	373	379	1	1	2	2	3	4	4	5	6
<b>698</b>		386	392	398	404	410	417	423	429	435	442	1	1	2	2	3	4	4	5	6
<b>699</b>		448	454	460	466	473	479	485	491	497	504	1	1	2	2	3	4	4	5	6
<b>700</b>		510	516	522	528	535	541	547	553	559	566	1	1	2	2	3	4	4	5	6



FIVE-FIGURE LOGARITHMS : 700—750

											PROPORTIONAL PARTS									
	0	1	2	3	4	5	6	7	8	9	1	2	3	4	5	6	7	8	9	
700	84	510	516	522	528	535	541	547	553	559	566	1	1	2	2	3	4	4	5	6
701		572	578	584	590	597	603	609	615	621	628	1	1	2	2	3	4	4	5	6
702		634	640	646	652	658	665	671	677	683	689	1	1	2	2	3	4	4	5	6
703		696	702	708	714	720	726	733	739	745	751	1	1	2	2	3	4	4	5	6
704		757	763	770	776	782	788	794	800	807	813	1	1	2	2	3	4	4	5	6
705		819	825	831	837	844	850	856	862	868	874	1	1	2	2	3	4	4	5	6
706		880	887	893	899	905	911	917	924	930	936	1	1	2	2	3	4	4	5	6
707		942	948	954	960	967	973	979	985	991	997	1	1	2	2	3	4	4	5	6
708	85	003	009	016	022	028	034	040	046	052	058	1	1	2	2	3	4	4	5	6
709		065	071	077	083	089	095	101	107	114	120	1	1	2	2	3	4	4	5	6
710		126	132	138	144	150	156	163	169	175	181	1	1	2	2	3	4	4	5	6
711		187	193	199	205	211	217	224	230	236	242	1	1	2	2	3	4	4	5	5
712		248	254	260	266	272	278	285	291	297	303	1	1	2	2	3	4	4	5	5
713		309	315	321	327	333	339	345	352	358	364	1	1	2	2	3	4	4	5	5
714		370	376	382	388	394	400	406	412	418	425	1	1	2	2	3	4	4	5	5
715		431	437	443	449	455	461	467	473	479	485	1	1	2	2	3	4	4	5	5
716		491	497	503	510	516	522	528	534	540	546	1	1	2	2	3	4	4	5	5
717		552	558	564	570	576	582	588	594	600	606	1	1	2	2	3	4	4	5	5
718		612	618	625	631	637	643	649	655	661	667	1	1	2	2	3	4	4	5	5
719		673	679	685	691	697	703	709	715	721	727	1	1	2	2	3	4	4	5	5
720		733	739	745	751	757	763	769	775	781	788	1	1	2	2	3	4	4	5	5
721		794	800	806	812	818	824	830	836	842	848	1	1	2	2	3	4	4	5	5
722		854	860	866	872	878	884	890	896	902	908	1	1	2	2	3	4	4	5	5
723		914	920	926	932	938	944	950	956	962	968	1	1	2	2	3	4	4	5	5
724		974	980	986	992	998	004	010	016	022	028	1	1	2	2	3	4	4	5	5
725	86	034	040	046	052	058	064	070	076	082	088	1	1	2	2	3	4	4	5	5
726		094	100	106	112	118	124	130	136	141	147	1	1	2	2	3	4	4	5	5
727		153	159	165	171	177	183	189	195	201	207	1	1	2	2	3	4	4	5	5
728		213	219	225	231	237	243	249	255	261	267	1	1	2	2	3	4	4	5	5
729		273	279	285	291	297	303	308	314	320	326	1	1	2	2	3	4	4	5	5
730		332	338	344	350	356	362	368	374	380	386	1	1	2	2	3	4	4	5	5
731		392	398	404	410	416	421	427	433	439	445	1	1	2	2	3	4	4	5	5
732		451	457	463	469	475	481	487	493	499	504	1	1	2	2	3	4	4	5	5
733		510	516	522	528	534	540	546	552	558	564	1	1	2	2	3	4	4	5	5
734		570	576	582	587	593	599	605	611	617	623	1	1	2	2	3	4	4	5	5
735		629	635	641	646	652	658	664	670	676	682	1	1	2	2	3	4	4	5	5
736		688	694	700	705	711	717	723	729	735	741	1	1	2	2	3	4	4	5	5
737		747	753	759	764	770	776	782	788	794	800	1	1	2	2	3	4	4	5	5
738		806	812	817	823	829	835	841	847	853	859	1	1	2	2	3	4	4	5	5
739		864	870	876	882	888	894	900	906	911	917	1	1	2	2	3	4	4	5	5
740		923	929	935	941	947	953	958	964	970	976	1	1	2	2	3	4	4	5	5
741		982	988	994	999	005	011	017	023	029	035	1	1	2	2	3	4	4	5	5
742	87	040	046	052	058	064	070	075	081	087	093	1	1	2	2	3	4	4	5	5
743		099	105	111	116	122	128	134	140	146	151	1	1	2	2	3	4	4	5	5
744		157	163	169	175	181	186	192	198	204	210	1	1	2	2	3	4	4	5	5
745		216	221	227	233	239	245	251	256	262	268	1	1	2	2	3	3	4	5	5
746		274	280	286	291	297	303	309	315	320	326	1	1	2	2	3	3	4	5	5
747		332	338	344	350	355	361	367	373	379	384	1	1	2	2	3	3	4	5	5
748		390	396	402	408	413	419	425	431	437	442	1	1	2	2	3	3	4	5	5
749		448	454	460	466	471	477	483	489	495	500	1	1	2	2	3	3	4	5	5
750		506	512	518	523	529	535	541	547	552	558	1	1	2	2	3	3	4	5	5
		0	1	2	3	4	5	6	7	8	9	1	2	3	4	5	6	7	8	9

FIVE-FIGURE LOGARITHMS : 750—800

											PROPORTIONAL PARTS									
	0	1	2	3	4	5	6	7	8	9	1	2	3	4	5	6	7	8	9	
<b>750</b>	87	506	512	518	523	529	535	541	547	552	558	1	1	2	2	3	3	4	5	5
<b>751</b>		564	570	576	581	587	593	599	604	610	616	1	1	2	2	3	3	4	5	5
<b>752</b>		622	628	633	639	645	651	656	662	668	674	1	1	2	2	3	3	4	5	5
<b>753</b>		680	685	691	697	703	708	714	720	726	731	1	1	2	2	3	3	4	5	5
<b>754</b>		737	743	749	754	760	766	772	777	783	789	1	1	2	2	3	3	4	5	5
<b>755</b>		795	800	806	812	818	823	829	835	841	846	1	1	2	2	3	3	4	5	5
<b>756</b>		852	858	864	869	875	881	887	892	898	904	1	1	2	2	3	3	4	5	5
<b>757</b>		910	915	921	927	933	938	944	950	955	961	1	1	2	2	3	3	4	5	5
<b>758</b>		967	973	978	984	990	996	001	007	013	018	1	1	2	2	3	3	4	5	5
<b>759</b>	88	024	030	036	041	047	053	058	064	070	076	1	1	2	2	3	3	4	5	5
<b>760</b>		082	087	093	098	104	110	116	121	127	133	1	1	2	2	3	3	4	5	5
<b>761</b>		138	144	150	156	161	167	173	178	184	190	1	1	2	2	3	3	4	5	5
<b>762</b>		196	201	207	213	218	224	230	235	241	247	1	1	2	2	3	3	4	5	5
<b>763</b>		252	258	264	270	275	281	287	292	298	304	1	1	2	2	3	3	4	5	5
<b>764</b>		309	315	321	326	332	338	343	349	355	360	1	1	2	2	3	3	4	5	5
<b>765</b>		366	372	378	383	389	395	400	406	412	417	1	1	2	2	3	3	4	5	5
<b>766</b>		423	429	434	440	446	451	457	463	468	474	1	1	2	2	3	3	4	5	5
<b>767</b>		480	485	491	497	502	508	514	519	525	530	1	1	2	2	3	3	4	5	5
<b>768</b>		536	542	547	553	559	564	570	576	581	587	1	1	2	2	3	3	4	5	5
<b>769</b>		593	598	604	610	615	621	627	632	638	643	1	1	2	2	3	3	4	5	5
<b>770</b>		649	655	660	666	672	677	683	689	694	700	1	1	2	2	3	3	4	5	5
<b>771</b>		705	711	717	722	728	734	739	745	750	756	1	1	2	2	3	3	4	5	5
<b>772</b>		762	767	773	779	784	790	795	801	807	812	1	1	2	2	3	3	4	4	5
<b>773</b>		818	824	829	835	840	846	852	857	863	868	1	1	2	2	3	3	4	4	5
<b>774</b>		874	880	885	891	897	902	908	913	919	925	1	1	2	2	3	3	4	4	5
<b>775</b>		930	936	941	947	953	958	964	969	975	981	1	1	2	2	3	3	4	4	5
<b>776</b>		986	992	997	003	009	014	020	025	031	037	1	1	2	2	3	3	4	4	5
<b>777</b>	89	042	048	053	059	064	070	076	081	087	092	1	1	2	2	3	3	4	4	5
<b>778</b>		098	104	109	115	120	126	131	137	143	148	1	1	2	2	3	3	4	4	5
<b>779</b>		154	159	165	170	176	182	187	193	198	204	1	1	2	2	3	3	4	4	5
<b>780</b>		209	215	221	226	232	237	243	248	254	260	1	1	2	2	3	3	4	4	5
<b>781</b>		265	271	276	282	287	293	298	304	310	315	1	1	2	2	3	3	4	4	5
<b>782</b>		321	326	332	337	343	348	354	360	365	371	1	1	2	2	3	3	4	4	5
<b>783</b>		376	382	387	393	398	404	409	415	421	426	1	1	2	2	3	3	4	4	5
<b>784</b>		432	437	443	448	454	459	465	470	476	481	1	1	2	2	3	3	4	4	5
<b>785</b>		487	493	498	504	509	515	520	526	531	537	1	1	2	2	3	3	4	4	5
<b>786</b>		542	548	553	559	564	570	575	581	586	592	1	1	2	2	3	3	4	4	5
<b>787</b>		597	603	609	614	620	625	631	636	642	647	1	1	2	2	3	3	4	4	5
<b>788</b>		653	658	664	669	675	680	686	691	697	702	1	1	2	2	3	3	4	4	5
<b>789</b>		708	713	719	724	730	735	741	746	752	757	1	1	2	2	3	3	4	4	5
<b>790</b>		763	768	774	779	785	790	796	801	807	812	1	1	2	2	3	3	4	4	5
<b>791</b>		818	823	829	834	840	845	851	856	862	867	1	1	2	2	3	3	4	4	5
<b>792</b>		873	878	883	889	894	900	905	911	916	922	1	1	2	2	3	3	4	4	5
<b>793</b>		927	933	938	944	949	955	960	966	971	977	1	1	2	2	3	3	4	4	5
<b>794</b>		982	988	993	998	004	009	015	020	026	031	1	1	2	2	3	3	4	4	5
<b>795</b>	90	037	042	048	053	059	064	069	075	080	086	1	1	2	2	3	3	4	4	5
<b>796</b>		091	097	102	108	113	119	124	129	135	140	1	1	2	2	3	3	4	4	5
<b>797</b>		146	151	157	162	168	173	179	184	189	195	1	1	2	2	3	3	4	4	5
<b>798</b>		200	206	211	217	222	227	233	238	244	249	1	1	2	2	3	3	4	4	5
<b>799</b>		255	260	266	271	276	282	287	293	298	304	1	1	2	2	3	3	4	4	5
<b>800</b>		309	314	320	325	331	336	342	347	352	358	1	1	2	2	3	3	4	4	5
		0	1	2	3	4	5	6	7	8	9	1	2	3	4	5	6	7	8	9

FIVE-FIGURE LOGARITHMS : 800—850

											PROPORTIONAL PARTS									
	0	1	2	3	4	5	6	7	8	9	1	2	3	4	5	6	7	8	9	
800	90	309	314	320	325	331	336	342	347	352	358	1	1	2	2	3	3	4	4	5
801		363	369	374	380	385	390	396	401	407	412	1	1	2	2	3	3	4	4	5
802		417	423	428	434	439	444	450	455	461	466	1	1	2	2	3	3	4	4	5
803		472	477	482	488	493	499	504	509	515	520	1	1	2	2	3	3	4	4	5
804		526	531	536	542	547	553	558	563	569	574	1	1	2	2	3	3	4	4	5
805		580	585	590	596	601	607	612	617	623	628	1	1	2	2	3	3	4	4	5
806		634	639	644	650	655	660	666	671	677	682	1	1	2	2	3	3	4	4	5
807		687	693	698	704	709	714	720	725	730	736	1	1	2	2	3	3	4	4	5
808		741	747	752	757	763	768	773	779	784	789	1	1	2	2	3	3	4	4	5
809		795	800	806	811	816	822	827	832	838	843	1	1	2	2	3	3	4	4	5
810		849	854	859	865	870	875	881	886	891	897	1	1	2	2	3	3	4	4	5
811		902	907	913	918	924	929	934	940	945	950	1	1	2	2	3	3	4	4	5
812		956	961	966	972	977	982	988	993	998	004	1	1	2	2	3	3	4	4	5
813	91	009	014	020	025	030	036	041	046	052	057	1	1	2	2	3	3	4	4	5
814		062	068	073	078	084	089	094	100	105	110	1	1	2	2	3	3	4	4	5
815		116	121	126	132	137	142	148	153	158	164	1	1	2	2	3	3	4	4	5
816		169	174	180	185	190	196	201	206	212	217	1	1	2	2	3	3	4	4	5
817		222	228	233	238	243	249	254	259	265	270	1	1	2	2	3	3	4	4	5
818		275	281	286	291	297	302	307	312	318	323	1	1	2	2	3	3	4	4	5
819		328	334	339	344	350	355	360	365	371	376	1	1	2	2	3	3	4	4	5
820		381	387	392	397	403	408	413	418	424	429	1	1	2	2	3	3	4	4	5
821		434	440	445	450	455	461	466	471	477	482	1	1	2	2	3	3	4	4	5
822		487	492	498	503	508	514	519	524	529	535	1	1	2	2	3	3	4	4	5
823		540	545	551	556	561	566	572	577	582	587	1	1	2	2	3	3	4	4	5
824		593	598	603	609	614	619	624	630	635	640	1	1	2	2	3	3	4	4	5
825		645	651	656	661	666	672	677	682	687	693	1	1	2	2	3	3	4	4	5
826		698	703	709	714	719	724	730	735	740	745	1	1	2	2	3	3	4	4	5
827		751	756	761	766	772	777	782	787	793	798	1	1	2	2	3	3	4	4	5
828		803	808	814	819	824	829	834	840	845	850	1	1	2	2	3	3	4	4	5
829		855	861	866	871	876	882	887	892	897	903	1	1	2	2	3	3	4	4	5
830		908	913	918	924	929	934	939	944	950	955	1	1	2	2	3	3	4	4	5
831		960	965	971	976	981	986	991	997	002	007	1	1	2	2	3	3	4	4	5
832	92	012	018	023	028	033	038	044	049	054	059	1	1	2	2	3	3	4	4	5
833		065	070	075	080	085	091	096	101	106	111	1	1	2	2	3	3	4	4	5
834		117	122	127	132	137	143	148	153	158	163	1	1	2	2	3	3	4	4	5
835		169	174	179	184	189	195	200	205	210	215	1	1	2	2	3	3	4	4	5
836		221	226	231	236	241	247	252	257	262	267	1	1	2	2	3	3	4	4	5
837		273	278	283	288	293	298	304	309	314	319	1	1	2	2	3	3	4	4	5
838		324	330	335	340	345	350	355	361	366	371	1	1	2	2	3	3	4	4	5
839		376	381	387	392	397	402	407	412	418	423	1	1	2	2	3	3	4	4	5
840		428	433	438	443	449	454	459	464	469	474	1	1	2	2	3	3	4	4	5
841		480	485	490	495	500	505	511	516	521	526	1	1	2	2	3	3	4	4	5
842		531	536	542	547	552	557	562	567	572	578	1	1	2	2	3	3	4	4	5
843		583	588	593	598	603	609	614	619	624	629	1	1	2	2	3	3	4	4	5
844		634	639	645	650	655	660	665	670	675	681	1	1	2	2	3	3	4	4	5
845		686	691	696	701	706	711	716	722	727	732	1	1	2	2	3	3	4	4	5
846		737	742	747	752	758	763	768	773	778	783	1	1	2	2	3	3	4	4	5
847		788	793	799	804	809	814	819	824	829	834	1	1	2	2	3	3	4	4	5
848		840	845	850	855	860	865	870	875	881	886	1	1	2	2	3	3	4	4	5
849		891	896	901	906	911	916	921	927	932	937	1	1	2	2	3	3	4	4	5
850		942	947	952	957	962	967	973	978	983	988	1	1	2	2	3	3	4	4	5
		0	1	2	3	4	5	6	7	8	9	1	2	3	4	5	6	7	8	9

FIVE-FIGURE LOGARITHMS : 850—900

											PROPORTIONAL PARTS									
	0	1	2	3	4	5	6	7	8	9	1	2	3	4	5	6	7	8	9	
850	92	942	947	952	957	962	967	973	978	983	988	1	1	2	2	3	3	4	4	5
851		993	998	003	008	013	018	024	029	034	039	1	1	2	2	3	3	4	4	5
852	93	044	049	054	059	064	069	075	080	085	090	1	1	2	2	3	3	4	4	5
853		095	100	105	110	115	120	125	131	136	141	1	1	2	2	3	3	4	4	5
854		146	151	156	161	166	171	176	181	186	192	0	1	2	2	3	3	4	4	5
855		197	202	207	212	217	222	227	232	237	242	0	1	2	2	3	3	4	4	5
856		247	252	258	263	268	273	278	283	288	293	0	1	2	2	3	3	4	4	5
857		298	303	308	313	318	323	328	334	339	344	0	1	2	2	3	3	4	4	5
858		349	354	359	364	369	374	379	384	389	394	0	1	2	2	3	3	4	4	5
859		399	404	409	414	420	425	430	435	440	445	0	1	2	2	3	3	4	4	5
860		450	455	460	465	470	475	480	485	490	495	0	1	2	2	3	3	4	4	5
861		500	505	510	515	520	526	531	536	541	546	0	1	2	2	3	3	4	4	5
862		551	556	561	566	571	576	581	586	591	596	0	1	2	2	3	3	4	4	5
863		601	606	611	616	621	626	631	636	641	646	0	1	2	2	3	3	4	4	5
864		651	656	661	666	671	676	682	687	692	697	0	1	2	2	3	3	4	4	5
865		702	707	712	717	722	727	732	737	742	747	0	1	2	2	3	3	4	4	5
866		752	757	762	767	772	777	782	787	792	797	0	1	2	2	2	3	4	4	5
867		802	807	812	817	822	827	832	837	842	847	0	1	2	2	2	3	4	4	4
868		852	857	862	867	872	877	882	887	892	897	0	1	2	2	2	3	4	4	4
869		902	907	912	917	922	927	932	937	942	947	0	1	2	2	2	3	3	4	4
870		952	957	962	967	972	977	982	987	992	997	0	1	1	2	2	3	3	4	4
871	94	002	007	012	017	022	027	032	037	042	047	0	1	1	2	2	3	3	4	4
872		052	057	062	067	072	077	082	086	091	096	0	1	1	2	2	3	3	4	4
873		101	106	111	116	121	126	131	136	141	146	0	1	1	2	2	3	3	4	4
874		151	156	161	166	171	176	181	186	191	196	0	1	1	2	2	3	3	4	4
875		201	206	211	216	221	226	231	236	240	245	0	1	1	2	2	3	3	4	4
876		250	255	260	265	270	275	280	285	290	295	0	1	1	2	2	3	3	4	4
877		300	305	310	315	320	325	330	335	340	344	0	1	1	2	2	3	3	4	4
878		349	354	359	364	369	374	379	384	389	394	0	1	1	2	2	3	3	4	4
879		399	404	409	414	419	424	429	433	438	443	0	1	1	2	2	3	3	4	4
880		448	453	458	463	468	473	478	483	488	493	0	1	1	2	2	3	3	4	4
881		498	503	507	512	517	522	527	532	537	542	0	1	1	2	2	3	3	4	4
882		547	552	557	562	567	571	576	581	586	591	0	1	1	2	2	3	3	4	4
883		596	601	606	611	616	621	626	630	635	640	0	1	1	2	2	3	3	4	4
884		645	650	655	660	665	670	675	680	685	689	0	1	1	2	2	3	3	4	4
885		694	699	704	709	714	719	724	729	734	738	0	1	1	2	2	3	3	4	4
886		743	748	753	758	763	768	773	778	783	787	0	1	1	2	2	3	3	4	4
887		792	797	802	807	812	817	822	827	832	836	0	1	1	2	2	3	3	4	4
888		841	846	851	856	861	866	871	876	880	885	0	1	1	2	2	3	3	4	4
889		890	895	900	905	910	915	919	924	929	934	0	1	1	2	2	3	4	4	4
890		939	944	949	954	959	963	968	973	978	983	0	1	1	2	2	3	3	4	4
891		988	993	998	002	007	012	017	022	027	032	0	1	1	2	2	3	3	4	4
892	95	036	041	046	051	056	061	066	071	075	080	0	1	1	2	2	3	3	4	4
893		085	090	095	100	105	109	114	119	124	129	0	1	1	2	2	3	3	4	4
894		134	139	143	148	153	158	163	168	173	177	0	1	1	2	2	3	3	4	4
895		182	187	192	197	202	207	211	216	221	226	0	1	1	2	2	3	3	4	4
896		231	236	240	245	250	255	260	265	270	274	0	1	1	2	2	3	3	4	4
897		279	284	289	294	299	303	308	313	318	323	0	1	1	2	2	3	3	4	4
898		328	332	337	342	347	352	357	361	366	371	0	1	1	2	2	3	3	4	4
899		376	381	386	390	395	400	405	410	415	419	0	1	1	2	2	3	3	4	4
900		424	429	434	439	444	448	453	458	463	468	0	1	1	2	2	3	3	4	4

FIVE-FIGURE LOGARITHMS : 900—950

											PROPORTIONAL PARTS									
	0	1	2	3	4	5	6	7	8	9	1	2	3	4	5	6	7	8	9	
900	95	424	429	434	439	444	448	453	458	463	468	0	1	1	2	2	3	3	4	4
901		472	477	482	487	492	497	501	506	511	516	0	1	1	2	2	3	3	4	4
902		521	525	530	535	540	545	550	554	559	564	0	1	1	2	2	3	3	4	4
903		569	574	578	583	588	593	598	602	607	612	0	1	1	2	2	3	3	4	4
904		617	622	626	631	636	641	646	650	655	660	0	1	1	2	2	3	3	4	4
905		665	670	674	679	684	689	694	698	703	708	0	1	1	2	2	3	3	4	4
906		713	718	722	727	732	737	742	746	751	756	0	1	1	2	2	3	3	4	4
907		761	766	770	775	780	785	789	794	799	804	0	1	1	2	2	3	3	4	4
908		809	813	818	823	828	832	837	842	847	852	0	1	1	2	2	3	3	4	4
909		856	861	866	871	875	880	885	890	895	899	0	1	1	2	2	3	3	4	4
910		904	909	914	918	923	928	933	938	942	947	0	1	1	2	2	3	3	4	4
911		952	957	961	966	971	976	980	985	990	995	0	1	1	2	2	3	3	4	4
912		999	004	009	014	019	023	028	033	038	042	0	1	1	2	2	3	3	4	4
913	96	047	052	057	061	066	071	076	080	085	090	0	1	1	2	2	3	3	4	4
914		095	099	104	109	114	118	123	128	133	137	0	1	1	2	2	3	3	4	4
915		142	147	152	156	161	166	171	175	180	185	0	1	1	2	2	3	3	4	4
916		190	194	199	204	209	213	218	223	227	232	0	1	1	2	2	3	3	4	4
917		237	242	246	251	256	261	265	270	275	280	0	1	1	2	2	3	3	4	4
918		284	289	294	298	303	308	313	317	322	327	0	1	1	2	2	3	3	4	4
919		332	336	341	346	350	355	360	365	369	374	0	1	1	2	2	3	3	4	4
920		379	384	388	393	398	402	407	412	417	421	0	1	1	2	2	3	3	4	4
921		426	431	435	440	445	450	454	459	464	468	0	1	1	2	2	3	3	4	4
922		473	478	483	487	492	497	501	506	511	515	0	1	1	2	2	3	3	4	4
923		520	525	530	534	539	544	548	553	558	562	0	1	1	2	2	3	3	4	4
924		567	572	577	581	586	591	595	600	605	609	0	1	1	2	2	3	3	4	4
925		614	619	624	628	633	638	642	647	652	656	0	1	1	2	2	3	3	4	4
926		661	666	670	675	680	685	689	694	699	703	0	1	1	2	2	3	3	4	4
927		708	713	717	722	727	731	736	741	745	750	0	1	1	2	2	3	3	4	4
928		755	759	764	769	774	778	783	788	792	797	0	1	1	2	2	3	3	4	4
929		802	806	811	816	820	825	830	834	839	844	0	1	1	2	2	3	3	4	4
930		848	853	858	862	867	872	876	881	886	890	0	1	1	2	2	3	3	4	4
931		895	900	904	909	914	918	923	928	932	937	0	1	1	2	2	3	3	4	4
932		942	946	951	956	960	965	970	974	979	984	0	1	1	2	2	3	3	4	4
933		988	993	997	002	007	011	016	021	025	030	0	1	1	2	2	3	3	4	4
934	97	035	039	044	049	053	058	063	067	072	077	0	1	1	2	2	3	3	4	4
935		081	086	090	095	100	104	109	114	118	123	0	1	1	2	2	3	3	4	4
936		128	132	137	142	146	151	155	160	165	169	0	1	1	2	2	3	3	4	4
937		174	179	183	188	192	197	202	206	211	216	0	1	1	2	2	3	3	4	4
938		220	225	230	234	239	243	248	253	257	262	0	1	1	2	2	3	3	4	4
939		267	271	276	280	285	290	294	299	304	308	0	1	1	2	2	3	3	4	4
940		313	317	322	327	331	336	340	345	350	354	0	1	1	2	2	3	3	4	4
941		359	364	368	373	377	382	387	391	396	400	0	1	1	2	2	3	3	4	4
942		405	410	414	419	424	428	433	437	442	447	0	1	1	2	2	3	3	4	4
943		451	456	460	465	470	474	479	483	488	493	0	1	1	2	2	3	3	4	4
944		497	502	506	511	516	520	525	529	534	539	0	1	1	2	2	3	3	4	4
945		543	548	552	557	562	566	571	575	580	585	0	1	1	2	2	3	3	4	4
946		589	594	598	603	607	612	617	621	626	630	0	1	1	2	2	3	3	4	4
947		635	640	644	649	653	658	663	667	672	676	0	1	1	2	2	3	3	4	4
948		681	685	690	695	699	704	708	713	717	722	0	1	1	2	2	3	3	4	4
949		727	731	736	740	745	750	754	759	763	768	0	1	1	2	2	3	3	4	4
950		772	777	782	786	791	795	800	804	809	813	0	1	1	2	2	3	3	4	4
		0	1	2	3	4	5	6	7	8	9	1	2	3	4	5	6	7	8	9

FIVE-FIGURE LOGARITHMS : 950—1000

											PROPORTIONAL PARTS									
	0	1	2	3	4	5	6	7	8	9	1	2	3	4	5	6	7	8	9	
950	97	772	777	782	786	791	795	800	804	809	813	0	1	1	2	2	3	3	4	4
951		818	823	827	832	836	841	845	850	855	859	0	1	1	2	2	3	3	4	4
952		864	868	873	877	882	886	891	896	900	905	0	1	1	2	2	3	3	4	4
953		909	914	918	923	928	932	937	941	946	950	0	1	1	2	2	3	3	4	4
954		955	959	964	968	973	978	982	987	991	996	0	1	1	2	2	3	3	4	4
955	98	000	005	009	014	019	023	028	032	037	041	0	1	1	2	2	3	3	4	4
956		046	050	055	059	064	068	073	078	082	087	0	1	1	2	2	3	3	4	4
957		091	096	100	105	109	114	118	123	127	132	0	1	1	2	2	3	3	4	4
958		137	141	146	150	155	159	164	168	173	177	0	1	1	2	2	3	3	4	4
959		182	186	191	195	200	204	209	214	218	223	0	1	1	2	2	3	3	4	4
960		227	232	236	241	245	250	254	259	263	268	0	1	1	2	2	3	3	4	4
961		272	277	281	286	290	295	299	304	308	313	0	1	1	2	2	3	3	4	4
962		318	322	327	331	336	340	345	349	354	358	0	1	1	2	2	3	3	4	4
963		363	367	372	376	381	385	390	394	399	403	0	1	1	2	2	3	3	4	4
964		408	412	417	421	426	430	435	439	444	448	0	1	1	2	2	3	3	4	4
965		453	457	462	466	471	475	480	484	489	493	0	1	1	2	2	3	3	4	4
966		498	502	507	511	516	520	525	529	534	538	0	1	1	2	2	3	3	4	4
967		543	547	552	556	561	565	570	574	579	583	0	1	1	2	2	3	3	4	4
968		588	592	597	601	605	610	614	619	623	628	0	1	1	2	2	3	3	4	4
969		632	637	641	646	650	655	659	664	668	673	0	1	1	2	2	3	3	4	4
970		677	682	686	691	695	700	704	709	713	717	0	1	1	2	2	3	3	4	4
971		722	726	731	735	740	744	749	753	758	762	0	1	1	2	2	3	3	4	4
972		767	771	776	780	784	789	793	798	802	807	0	1	1	2	2	3	3	4	4
973		811	816	820	825	829	834	838	843	847	851	0	1	1	2	2	3	3	4	4
974		856	860	865	869	874	878	883	887	892	896	0	1	1	2	2	3	3	4	4
975		900	905	909	914	918	923	927	932	936	941	0	1	1	2	2	3	3	4	4
976		945	949	954	958	963	967	972	976	981	985	0	1	1	2	2	3	3	4	4
977		989	994	998	003	007	012	016	021	025	029	0	1	1	2	2	3	3	4	4
978	99	034	038	043	047	052	056	061	065	069	074	0	1	1	2	2	3	3	4	4
979		078	083	087	092	096	100	105	109	114	118	0	1	1	2	2	3	3	4	4
980		123	127	131	136	140	145	149	154	158	162	0	1	1	2	2	3	3	4	4
981		167	171	176	180	185	189	193	198	202	207	0	1	1	2	2	3	3	4	4
982		211	216	220	224	229	233	238	242	247	251	0	1	1	2	2	3	3	4	4
983		255	260	264	269	273	277	282	286	291	295	0	1	1	2	2	3	3	4	4
984		300	304	308	313	317	322	326	330	335	339	0	1	1	2	2	3	3	4	4
985		344	348	352	357	361	366	370	374	379	383	0	1	1	2	2	3	3	4	4
986		388	392	396	401	405	410	414	419	423	427	0	1	1	2	2	3	3	4	4
987		432	436	441	446	449	454	458	463	467	471	0	1	1	2	2	3	3	4	4
988		476	480	484	489	493	498	502	506	511	515	0	1	1	2	2	3	3	4	4
989		520	524	528	533	537	542	546	550	555	559	0	1	1	2	2	3	3	4	4
990		564	568	572	577	581	585	590	594	599	603	0	1	1	2	2	3	3	4	4
991		607	612	616	621	625	629	634	638	642	647	0	1	1	2	2	3	3	4	4
992		651	656	660	664	669	673	677	682	686	691	0	1	1	2	2	3	3	4	4
993		695	699	704	708	712	717	721	726	730	734	0	1	1	2	2	3	3	3	4
994		739	743	747	752	756	760	765	769	774	778	0	1	1	2	2	3	3	3	4
995		782	787	791	795	800	804	808	813	817	822	0	1	1	2	2	3	3	3	4
996		826	830	835	839	843	848	852	856	861	865	0	1	1	2	2	3	3	3	4
997		870	874	878	883	887	891	896	900	904	909	0	1	1	2	2	3	3	3	4
998		913	917	922	926	930	935	939	944	948	952	0	1	1	2	2	3	3	3	4
999		957	961	965	970	974	978	983	987	991	996	0	1	1	2	2	3	3	3	4



# INDEX

- Acetic acid, as solvent for titration of weak bases, 667-672  
determination of water in, 822  
for titration of amines, 696, 699  
for titration of amino acids, 706, 708  
for titration of amine salts, 702, 704  
for titration of carboxylic acid salts, 719, 720, 838  
for titration of picrates of amines, 696, 701  
for titration of potassium alkyl xanthates, 839, 840  
for titration of quaternary ammonium halides, 703, 704, 705  
indicators for titration in, 670, 672
- Acetic anhydride, analysis of, 724, 727  
determination of water content of, 823
- Acetic anhydride in pyridine, reagent, 677, 688, 694, 697, 822
- Acetone, determination of, 830, 831
- Acetous perchloric acid; *see* Perchloric acid in acetic acid
- Acetyl esters, analysis of, 730
- N-Acetyl groups, 777, 778  
semimicro determination of, 781
- O-Acetyl groups, 777, 778  
apparatus for, 778  
semimicro determination of, 780, 781
- Acetylation; *see* Amino groups: Hydroxyl groups
- Acids, titration in non-aqueous solvents, 672-675
- Acids and bases, concepts of, 663-666  
Brönsted-Lowry theory of, 663, 664  
G. N. Lewis theory of, 664-665
- Active hydrogen determination, 782-790  
apparatus for, 786, 788  
with lithium aluminium hydride, 783, 789, 790  
with methyl magnesium iodide in anisole or in amyl ether, 782, 783-787  
with methyl magnesium iodide in diethyl ether, 782, 787-789
- Adams' platinum oxide catalyst, 760, 764  
preparation of, 762
- Alcohols, determination of; *see* Hydroxyl groups (alcohols): Hydroxyl groups (adjacent)
- Aldehydes and ketones, determination of, 734-739  
by bisulphite (aldehydes), 734-736  
by hydroxylamine, 734, 736, 737  
by 2:4-dinitrophenylhydrazine, 736, 739
- Aldoses, determination of; *see* Carbohydrates
- Alkoxy groups, determination of, 771-776; *see also* Methoxyl and Ethoxyl groups
- Alkyl disulphides; *see* Disulphides
- Alkyl sulphides; *see* Sulphides
- Alpha-epoxy groups; *see*  $\alpha$ -Epoxy groups
- Amine salts, determination of, 702-705  
by titration in aqueous solution, 702, 703, 704  
by titration in glacial acetic acid, 696, 704
- Amines, determination of; *see* Amino groups
- Amino acids, determination of, 706-710  
by titration in glacial acetic acid, 706, 708  
by titration in pyridine or in ethylenediamine, 707, 708  
formol titration, 706, 709  
Van Slyke method, 707
- Amino groups, determination of, 694-701  
by acetylation, 694, 697  
by analysis of chloroplatinates, 696, 700  
by analysis of picrates, 696, 701  
by bromination, 695, 698  
by titration as bases, 695, 698, 699  
with Karl Fischer reagent, 816, 822
- Anhydrides of carboxylic acids; *see* Carboxylic acid anhydrides
- Aniline, quantitative bromination of, 695, 698



- Anion exchange column, preparation of, 808
- Anisole, purification of, 785
- Antimony electrode for non-aqueous titrations, 673, 707, 794
- Atomic weights, table of, *A* i
- Azo groups, determination of, by Ti (III) reduction, 748, 754, 755
- Azo violet indicator, 673, 692
- Azotometer: *see* Nitrometer
- Balance, prismatic, 645  
semimicro, 645
- Barium hydroxide solution, 0.05*N*, 714, 778  
storage vessel for, 714
- Bases, titration in non-aqueous solvents, 667-672
- Benzidine hydrochloride reagent, 660, 661
- Benzoic anhydride, analysis of, 724, 727
- S-Benzyl-*iso*-thiuronium salts, titration with acetous perchloric acid, 838, 839
- Blank determinations, advantages of, 676
- Boric acid, aqueous, for absorption of ammonia, 652, 656
- Bromate-bromide solution, 686  
for bromination of amines, 695, 698  
for bromination of phenols, 686, 689, 690  
for bromination of unsaturated compounds, 756, 765, 766  
for determination of sulphides, 802, 803  
preparation of, 0.1*N*, 803; 0.2*N*, 689, 765
- Bromination, quantitative, of amines, 695, 698  
of enols, 792  
of phenols, 686, 689, 690  
of unsaturated compounds, 756, 757, 765, 766
- Bromine, for quantitative oxidation of sulphides, 802, 803
- Bromine number, 757, 766, 770
- Brönsted-Lowry theory of acids and bases, 663-664
- Bunsen valve, 789
- n*-Butylamine, as solvent for titration of weak acids, 672
- Calomel electrode, 668, 673  
modified, 688
- Carbohydrates, determination of, 740-746  
of aldoses, by hypiodite, 740, 741-743  
of reducing sugars, with Fehling's solution, 743-746
- Carbon dioxide generator, 649, 650
- Carbon-methyl determination; *see* C-Methyl groups
- Carbonyl groups, determination of; *see* Aldehydes and Ketones
- Carboxyl groups, determination of, 711-718  
by analysis of the S-benzyl-*iso*-thiuronium salts, 838, 839  
by analysis of the silver salts, 713, 717, 718  
by direct titration in aqueous or in alcoholic solution, 711, 712, 714, 715  
by direct titration in non-aqueous solvents, 712, 713, 716  
by iodometric titration, 713, 716
- Carboxylic acid anhydrides, determination of, 723-727  
by esterification-hydrolysis method, 723, 724 [727  
by morpholine method, 723, 726,
- Carboxylic acid esters, determination of, 728-733  
by hydrolysis with alcoholic alkali hydroxide, 729, 731, 732  
by hydrolysis with aqueous alkali hydroxide, 728, 730  
by hydrolysis with potassium hydroxide in diethyleneglycol, 729, 732, 733  
by hydrolysis - ion exchange method, 730, 809-812
- Carboxylic acids, analysis of; *see* Carboxyl groups
- Carboxylic acid salts, determination of, 719-722  
by ignition, 719, 721  
by titration in glacial acetic acid, 719, 720  
by use of ion exchange resins, 806, 807
- Catalytic hydrogenation; *see* Hydrogenation
- Catalysts, for Kjeldahl determination, 653
- Cation exchange column, preparation of, 807

- Chloroplatinates of bases, analysis of, 696, 700
- Cinnamic acid, reduction of, 761
- Combustion tube, for Dumas nitrogen determination, 647, 648
- Copper oxide, reduced, 648
- Crystal violet indicator, 672, 699, 720
- Cupric *n*-butyl phthalate, 799  
preparation of, 801
- Dead stop end point in water determination, 814
- Dextrose, determination of; *see* D-Glucose
- Dialkyl sulphides; *see* Disulphides
- Diethyl ether, as solvent for active hydrogen determination, 787, 788
- Di-*n*-butyl ether, purification of, 790
- Di-*n*-butyl phthalate, manometric fluid for active hydrogen determination, 786
- Differential titration curve, 670, 671
- Dimethylformamide, determination of water in, 821  
purification of, 692
- Dimethylformamide, solvent, for titration of carboxylic acids, 716  
for titration of enols, 793  
for titration of imides, 794  
for titration of phenols, 692  
for titration of sulphonamides, 797  
for titration of weak acids, 672, 673
- 2:4-Dinitrophenylhydrazine, use in determination of carbonyl compounds, 736, 739
- Dioxan, 659, 668  
in hydrochloric acid, 0.2*N*, 825
- Disulphides, determination of, 804
- Double bonds, determination of; *see* Unsaturation
- Double indicator method, 729
- Dumas determination of nitrogen, semimicro, 646-652
- Electrodes, antimony, 673, 707, 794  
calomel, 668, 688  
glass 673  
silver/silver chloride, 668, 669
- End points, determination with colorimeter, 675  
from titration curves, 670-672  
with indicators in non-aqueous titrations, 670, 672, 673, 674
- Enols, determination of, 791-793  
by titration in non-aqueous solvents, 793  
by titration with bromine, 792
- $\alpha$ -Epoxy groups, determination of, 824-827  
by acidimetric method, 825, 826  
by argentimetric method, 826, 827
- Equivalent weights, determination of,  
of alcohols, 839, 840  
of amines, 700, 701  
of carboxylic acids, 714-718, 838, 839
- Esters of carboxylic acids; *see* Carboxylic acid esters.
- Ethanol, determination of water in, 822  
neutral, 825
- Ethanolamine, 657, 658, 659
- Ethoxyl groups, semimicro determination of, 775, 776
- Ethylenediamine, as solvent for titration of amino acids, 707, 708  
as solvent for titration of phenols, 693  
as solvent for titration of weak acids, 672  
purification of, 692
- Ethyleneglycol, determination of, 680, 682, 684
- Fehling's solution, 743-746  
preparation of, 743  
standardisation of, 743, 744, 745  
use of, 744-746
- Ferric alum solution, as indicator, 800, *cf.* 826  
for standardisation of Ti (III) solutions, 748, 749, 751
- Fieser's solution, preparation of, 785
- Fischer reagent; *see* Karl Fischer reagent
- Formaldehyde, determination of, by hydroxylamine hydrochloride method, 828, 829, 830  
by sodium hypiodite method, 828, 829
- Formol titration, of amino acids, 706, 709

- Gas burette, 834
- Gasometric method, for determination of active hydrogen, 785-788  
for determination of aromatic hydrazines, 831-833  
for determination of urea, 833-835
- Glass electrode, 673
- D-Glucose, determination of, 682
- Glycerol, determination of, 680, 682  
determination of water in, 821
- Glycols; *see* Hydroxyl groups (adjacent)
- Grignard reagent for active hydrogen determination, 782  
preparation of, in anisole, 783-785  
preparation of, in diethyl ether, 787, 788
- Halogens, determination of, by modified Stepanow method, 657-659
- Hanus iodine monobromide solution, 757  
preparation of, 768
- Hübl reagent, 757
- Hydrazines, aromatic, determination by gasometric method, 831-833
- Hydriodic acid, preparation of, for alkoxy determination, 774, 775
- Hydrochloric acid in dioxan, 0.2*N*, 825
- Hydrogenation, 758-765  
apparatus for, macro, 758, 759  
apparatus for, semimicro, 763-765  
for determination of unsaturation, 756, 758-761, 764, 765  
of cinnamic acid, 761  
of maleic acid, 760, 761, 764  
platinum oxide catalyst for, 756, 760, 762  
stabilised Raney nickel catalyst for, 756, 761
- Hydroperoxides, organic, determination of, 836, 837
- Hydroxyl groups, adjacent, determination of, 680-685  
by acidimetric procedure, 681, 683-685  
by iodometric procedure, 681-683
- Hydroxyl groups (alcohols), determination of, 676-679  
by acetylation, 676, 677  
by phthalation, 677, 679  
by potassium alkyl xanthates, 839, 840
- Hydroxyl groups (phenols), determination of, 686-693  
by acetylation, 686, 688  
by bromination, 686, 689, 690  
by titration in non-aqueous solvents, 687, 688, 691-693
- Hydroxylamine hydrochloride reagent, for determination of carbonyl groups, 736
- Imides, determination of, 794, 795  
by titration in dimethylformamide, 794, 795
- Indicators for acid-base titrations in non-aqueous solutions, 670, 672, 673, 674
- "Invert" sugar, 745, 746
- Iodine flask, 678  
modified, 678
- Iodine monobromide solution, 757, 768
- Iodine monochloride solution, 757, 767
- Iodine number, 757  
determination of, 767, 768
- Iodine solution, 0.1*N*, 716
- Iodometric titration of carboxylic acids, 713, 716
- Ion exchange resins, 805, 806  
determinations using, 805-812  
in determination of alkaloidal salts, 808, 809  
in determination of salts of organic acids, 807  
in determination of salts of organic bases, 808  
in determination of saponification equivalents of esters, 809, 810  
preparation of anion exchange column, 808  
preparation of cation exchange column, 807  
regeneration of, 810
- Isocyanates, determination of, 837
- Isothiocyanates, determination of, 837, 838

- Karl Fischer reagent, 813-823  
 apparatus for use with, 817, 818, 819  
 applications of, 814-816  
 detection of end points in titrations with, 813, 814  
 in determination of acetic anhydride, 823  
 in determination of primary amines, 822  
 in determination of water content of organic solvents, 821, 822  
 in determination of water content of salt hydrates, 820, 822  
 preparation of, 813, 816, 817  
 standardisation of, 814, 817, 820
- Kjeldahl flask, 653  
 stand for, 654
- Kjeldahl method for semimicro determination of nitrogen, 652-657  
 catalysts for, 653  
 distillation apparatus for, 655
- Levelling effect of solvents, 666
- Lewis acids, 665
- Lewis theory of acids and bases, 664, 665
- Lithium aluminium hydride, in determination of active hydrogen, 783, 789, 790
- Logarithms, four-figure, *A* iv-v  
 five-figure, *A* vi-xxiii
- Magnetic stirrer, 669, 670, 674, 759, 761
- Malaprade reaction, 680
- Maleic acid, reduction to succinic acid, 760, 761
- Maleic anhydride, analysis of, 724
- Mannitol, determination of, 683, 684
- Mannose, determination of, 740, 742, 743
- Measuring techniques for semimicro quantities, 645
- Mercapto groups; *see* Thiols
- Mercuric acetate reagent, in determination of amine halides, 703, 704  
 in determination of unsaturation, 769; *cf.* 765
- Methanol, determination of water in, 821
- Methanolic bromine solution, 792
- Methanolic hydrochloric acid, 0.5*N*, 726
- Methoxyl groups, semimicro determination of, 770-775  
 apparatus for, 772
- C-Methyl groups, determination of, 777  
 apparatus for, 778  
 number, 780  
 semimicro determination of, 778-780
- Methyl violet indicator, 672, 699
- Methylene blue indicator, use with Fehling's solution, 744  
 use with solutions of Ti (III) salts, 749
- Monoethanolamine, 657, 658, 659
- Morpholine reagent, 726
- N-Acetyl determination; *see* N-Acetyl groups
- $\beta$ -Naphthol, analysis of, 693  
 quantitative bromination of, 690
- $\alpha$ -Naphtholbenzein indicator, 672, 699
- Neutralisation equivalents, of acids, 712-718  
 of bases, 696, 698-701
- Nickel catalyst; *see* Raney nickel
- Nitro groups, determination of, 747-753  
 by titanous salt reduction, 747, 752, 753  
 difficulties in Ti (III) reduction, 747
- o*-Nitroaniline indicator, 674, 692
- Nitrobenzene, for coagulation of silver chloride, 658
- Nitrogen, purification of, 785
- Nitrogen, semimicro determination by Dumas method, 646-652
- Nitrogen, semimicro determination, by Kjeldahl method, 652-657  
 catalysts for, 653  
 distillation apparatus for, 655  
 modifications of simple procedure, 653, 657  
 stand for, 654
- Nitrometer, 785, 786, 788, 832
- Nitrometer, semimicro, 648
- Nitroso groups, determination by Ti (III) reduction, 748, 753, 754

- Non-aqueous solvents, titrations in, handling of solutions in, 674  
 indicators for, 670, 672, 673  
 potentiometric titrations in, 668–671, 673  
 scope and limitations of, 666–675
- O-Acetyl groups, semimicro determination of, 777, 780
- Olefines; *see* Unsaturation
- Oximation reaction for determination of carbonyl groups, 734, 736, 737
- Oxirane compounds; *see*  $\alpha$ -Epoxy groups
- Perchloric acid in acetic acid, 664, 667, 671, 698, 701, 838, 839, 840  
 preparation of 0.1N, 698
- Perchloric acid in dioxan, 668
- Periodate titrations of polyhydric alcohols, etc., 680–685
- Periodic acid, 0.05N as monobasic acid, 681
- Peroxides, organic, determination of, 836, 837
- pH, in determination of aldehydes by bisulphite reaction, 735, 736, 738
- pH meter, 669, 670
- Phenol, quantitative bromination of, 689, 690
- Phenolphthalein indicator, 715, 724, 741, 778
- Phenols; *see* Hydroxyl groups (phenols)
- Phthalation, 677, 679
- Phthalic anhydride, 677, 679  
 analysis of, 724, 727  
 in pyridine, reagent, 679
- Picrates of amines, analysis of, by titration in acetic acid, 696, 701
- Picrates of some aromatic compounds, analysis of, by titration in aqueous solution, 701
- Platinum oxide catalyst (Adams'), 756, 760  
 preparation of, 762
- Polyhydric alcohols; *see* Hydroxyl groups, adjacent
- Potassium alkyl xanthates, 839  
 preparation of, 839, 840  
 use in determination of alcohols, 840
- Potassium bromate-bromide solutions; *see* Bromate-bromide solutions
- Potassium hydroxide solution, ethanolic, 0.5N, 731  
 50 per cent, 648  
 in diethyleneglycol, 0.5N, 732  
 vapour pressure of, 651
- Potassium methoxide in benzene-methanol, 0.1N, 687
- Potentiometric titration, 668–670, 673  
 apparatus for, 668–670  
 curve, 669, 671
- Propionic anhydride, analysis of, 727  
 use for alkoxyl determination, 773, 774
- Pyridine, as catalyst for titration of anhydrides, 723, 724  
 as solvent in quantitative acylation, 677, 679  
 as solvent for titration of acids, 673
- Pyridine-bromophenol blue solution, 736
- Pyridine sulphate dibromide solution, 757  
 preparation of, 769
- Quaternary ammonium halides, 703  
 titration in glacial acetic acid, 704, 705
- Quaternary ammonium hydroxides, as titrants, 672, 673, 688, 707, 713
- Raney nickel catalyst, stabilised, 756, 762  
 disposal of used, 760  
 use of, 761
- Reference works for quantitative organic analysis, A ii
- Salts of amines; *see* Amine salts
- Salts of carboxylic acids; *see* Carboxylic acid salts
- Saponification equivalent, 728  
 determination of, 729–733, 809–812
- Semimicro balance, 645  
 burettes, 715
- Semimicro quantities, weighing and measuring techniques for, 645, 646

- Silver salts of carboxylic acids, preparation and analysis of, 713, 717, 718
- Silver/silver chloride electrode, 668  
preparation of, 668, 669
- Sodium acetate, water content of, 822
- Sodium acetate in acetic acid, 0.1*N*, 708
- Sodium aminoethoxide solution in ethanolamine-ethylenediamine, 707  
for titration of amino acids, 707  
preparation of, 708
- Sodium aminoethoxide solution in ethylenediamine, 0.1*N*, 687  
for titration of phenols, 687
- Sodium antimonyl tartrate solution, for removal of hydrogen sulphide in alkoxy determination, 773, 774
- Sodium hydroxide solution, aqueous, 0.5*N*, 679, 724  
alcoholic, 0.5*N*, 677  
ethanolic, 0.5*N*, 731  
methanolic, 0.5*N*, 736; 0.1*N*, 825
- Sodium hypobromite solution, preparation of, 834
- Sodium metaperiodate solution, 0.1*M*, 683
- Sodium methoxide in benzene-methanol, 672, 687, 692, 712, 716, 791, 793  
preparation of, 0.1*N*, 691
- Sodium methoxide in methanol, 0.5*N*, 724
- Sodium sulphite-sulphuric acid procedure for aldehydes, 734, 735, 738
- Sodium tartrate dihydrate, use in Karl Fischer determinations, 820
- Sodium thiosulphate solution, 0.1*N*, 689, 765; 0.2*N*, 682
- Solvents, acidic (or protogenic), 666  
amphoteric (or amphiprotic), 665  
basic (or protophilic), 665  
determination of water content of, 821, 822  
for titration of weak acids, 672  
for titration of weak bases, 666-668  
levelling effect of, 666
- Starch indicator solution, 682, 765
- Stepanow method, modified, for halogens, 657-659
- Succinic anhydride, analysis of, 727
- Sucrose, analysis of, 74F
- Sugars, determination of; *see* Carbohydrates
- Sulphides, determination of, 802, 803
- Sulphonamides, determination of, 796-798  
by titration in dimethylformamide, 796, 797  
by titration with silver nitrate solution, 797, 798
- Sulphur, semimicro determination, Na<sub>2</sub>CO<sub>3</sub>-KNO<sub>3</sub> fusion method, 659-662  
gravimetric, 660  
volumetric, 662
- Tetra-*n*-butylammonium hydroxide in benzene-methanol as titrant, 672  
advantages of, 672, 707, 713  
preparation of, 673, 688
- Thioethers; *see* Sulphides
- Thiols, determination of, 798-802  
with cupric *n*-butyl phthalate solution, 801, 802  
with iodine solution, 799, 800  
with silver nitrate solution, 800, 801
- Thymol blue indicator, 673, 691, 716
- Titanous chloride solution, 747, 748  
difficulties with, 747, 748  
preparation of 0.1*N*, 749, 750  
standardisation of, 748, 749, 751  
752  
storage of, 750, 751
- Titanous salts, reductions with, 747-755
- Titanous sulphate solution, 747  
preparation of 0.1*N*, 750  
standardisation of, 748, 749, 751  
752  
storage of, 750, 751
- Titration curve, 669, 671  
differential, 670, 671
- Titration flasks, 674, 751; *see also* Iodine flask
- Titrations in non-aqueous solvents, apparatus for (potentiometric), 670  
end points of, 669-671  
indicators for, 670, 672, 637

- Titration in non-aqueous solvents,  
of acids, 672-675, 712, 716  
of amino acids, 707, 708  
of bases, 667-672, 695, 696, 698,  
699  
of phenols, 687, 691-693; *see also*  
Acetic acid: Dimethylform-  
amide: Ethylenediamine
- Triethyl-*n*-butylammonium hydr-  
oxide in benzene-methanol as  
titrant, 672  
preparation of, 0.1N, 673, 688
- Tube furnace, 647
- Unsaturation, determination of,  
756-770  
by bromination, 756, 757, 765,  
766, 769  
by bromine number, 757, 765,  
766, 769, 770  
by hydrogenation, 756, 758-762  
(macro), 763-765 (semimicro)  
by iodine number, 757, 767, 768
- Urea, determination of, by gaso-  
metric method, 833, 834, 835  
by gravimetric method, 835
- Vanillin, analysis of, 692
- Van Slyke method for amino acids,  
707
- Vapour pressure, of 50 per cent.  
potassium hydroxide solution,  
651  
of water at various temperatures,  
A iii
- Water, determination of; *see* Karl  
Fischer reagent
- Weighing bottle, 645, 646  
for liquids, 646
- Weighing tube, 646
- Weighing techniques for semimicro  
quantities, 645
- Wijs' iodine monochloride solution,  
757  
preparation of, 767
- Xanthates, alkyl, for quantitative  
determination of alcohols, 839,  
840
- Xanthhydrol, for determination of  
urea, 835
- Zeisel determination; *see* Alkoxy-  
groups
- Zerewitinoff's method for active  
hydrogen, 782  
apparatus for, 786  
solvents for 782